

RTD2660 series

Flat Panel Display Controller

*Preliminary
Revision*

Version 1.00

Last updated: 2007/6

Realtek Confidential for GM Only

1. FEATURES.....	5
2. CHIP DATA PATH BLOCK DIAGRAM	14
3. REGISTER DESCRIPTION	15
Common page	15
Global Event Flag.....	15
Watch Dog.....	19
Input Video Capture.....	21
Input Frame Window	25
FIFO Frequency	28
Input pattern generator.....	29
Display Format.....	30
Display Fine Tune	35
Cyclic-Redundant-Check.....	36
FIFO Window.....	37
Scaling Up Function	38
Frame Sync Fine Tune	42
Sync Processor	43
Macro Vision.....	54
Highlight window	55
Color Processor Control.....	60
Contrast/Brightness Coefficient	61
Gamma Control.....	62
Dithering Control	64
Overlay/Color Palette/Background Color Control.....	64
Image Auto Function	65
Embedded Timing Controller.....	71
TCON Horizontal/Vertical Timing Setting	72
Dot Masking.....	75
Control for LVDS	78
Embedded OSD.....	81
Digital Filter	82
VBI	84
Video Color Space Conversion	97
Paged Control Register	98
Embedded ADC (Page 0).....	99
Embedded VADC.....	99
Embedded YPP ADC	105
ABL(Page 0)	115
LVR(Page 0).....	119
ADC PLL (Page 1)	120
DISPLAY PLL (Page 1).....	131
DCLK Spread Spectrum (Page 1)	132
MULTIPLY PLL (Page 1).....	136
PLL27X	137
Reserved Page3~page5	139
De-interlace(Page 6)	139
Noise Estimation(Page 6)	141
Peaking and Coring and EMF/ Chroma Lowpass(Page 6).....	144

YUV422 to YUV444 Conversion & 2to1 Setup(page 6).....	147
DCTi (Dynamic Chromance Transition Improvement) in I-Domain(Page 6).....	148
Image Processor Performance (Noise Reduction in I-domain) Register Control(Page 6).....	149
Clean Picture™ (Noise Reduction in I-domain) Overall Control.....	149
Spatial noise reduction (Zoran Filter).....	149
Impulse noise reduction (Impulse Filter).....	150
Scale Down(page 6).....	150
Linear and Non-linear Scale Down.....	150
UZD_CRC_CTRL.....	155
Vivid color-DLTI/DCTi(Page 7).....	156
Peaking and Coring and EMF/ Chroma Lowpass(page 7).....	157
Vivid color-Video Color Space Conversion(page 7).....	168
Vivid color-DCC (Page 7).....	168
Y-Peaking filter and coring control (For Display Domain).....	179
Hue/Saturation Control (Page 7).....	181
Contrast/Brightness Control (Page 7).....	181
Page 8 Video decoder.....	182
Video Control Register.....	182
Switch Control Registers.....	182
Luma Adjustment Registers.....	184
Chroma Adjustment Registers.....	184
DC Balance Control.....	185
IRQ Registers.....	186
Status Registers_1.....	188
Status Registers_2.....	189
Reset Register.....	191
Auto Mode State Machine Registers.....	192
Comb Filter Configuration Register.....	195
Comb Filter Threshold Registers.....	195
2D YC Separation Registers.....	196
Page 9 Video Decoder.....	203
Clamping/AGC Control Registers.....	203
Chroma Loop Control Registers.....	207
HPLL Control Registers.....	209
Horizontal Sync Detection Registers.....	212
Vertical Sync and Field Detection Registers.....	214
VSYNC PLL Registers.....	216
Chroma DTO Registers.....	217
Horizontal Sync DTO Registers.....	217
Auto Mode State Machine Table Status Registers.....	219
Auto Mode Flag Counter Registers.....	220
Auto Mode Flag Adjustment Registers.....	222
FIFO Control Register.....	224
SECAM Control Registers.....	227
MISC Control Registers.....	228
Macrovision Control Registers.....	230
Debug Test.....	231
ADC Clamping Test Mode.....	234
Chip Version.....	235
Off line sync processor(page B).....	235
Auto SOY(page B).....	246
Reserved page.....	276
MCU register 1(page D).....	276
Interrupt Control.....	283
ADC.....	284
DDC.....	289
DDC-CI.....	293

PWM.....	300
I2C Control Module.....	306
MCU register 2(page E).....	311
SPI-FLASH.....	311
IrDA.....	318
Pin Share.....	326
CEC function	335
GPIO Control.....	340
SFR Access	348
Watchdog Timer.....	348
In System Programming	350
Scalar Interface	352
Bank Switch.....	355
Embedded OSD.....	358
OSD Compression.....	387
OSD Special Function	388
4. ELECTRIC SPECIFICATION.....	399
DC Characteristics.....	399
5. MECHANICAL SPECIFICATION.....	400
6. ORDERING INFORMATION.....	401

1. Features

General

- | Embedded 3 DDC with DDC1/2B/CI
- | Zoom scaling up and down
- | Embedded one MCU with SPI flash controller.
- | It contains 8 ADCs in D-connector, LED backlight, and key pad application
- | It supports infrared remote function
- | Require only one crystal to generate all timing.
- | Programmable internal low-voltage-reset (LVR)
- | High resolution 6 channels PWM output, and wide range selectable PWM frequency.
- | Support input format up to 1920(WUXGA)/1440-pixel width(option)

Analog RGB Input Interface

- | 2 Analog input supported with internal switch
- | Integrated 8-bit triple-channel 210/165MHz ADC/PLL(option)
- | Embedded programmable Schmitt trigger of HSYNC
- | Support Sync-On-Green (SOG) and various kinds of composite sync modes
- | On-chip high-performance hybrid PLLs
- | High resolution true 64 phase ADC PLL
- | Y/Pb/Pr support up to HDTV 1080p resolution

Embedded Video Decoder

- | High performance AV 2D Comb-filter
- | Support Composite, S Video, Component input
- | Support VBI with Closed caption/ V chip slicer

Video Input Interface

- | Support 8-bit video (ITU 656) format input

Embedded MCU

- | Industrial standard 8051 core with serial flash up to 256K bytes
- | Low speed ADC for various application
- | Infrared function supported
- | I2C Master or Slave hardware supported

Auto Detection /Auto Calibration

- | Input format detection
- | Compatibility with standard VESA mode and support user-defined mode
- | Smart engine for Phase/Image position/Color calibration

Scaling

- | Fully programmable zoom ratios
- | Independent horizontal/vertical scaling
- | Advanced zoom algorithm provides high image quality
- | Sharpness/Smooth filter enhancement
- | Support non-linear scaling from 4:3 to 16:9 or

16:9 to 4:3

Color Processor

- | True 10 bits color processing engine
- | sRGB compliance
- | Advanced dithering logic for 18-bit panel color depth enhancement
- | Dynamic overshoot-smear canceling engine
- | Brightness and contrast control
- | Programmable 10-bit gamma support
- | Peaking/Coring/XVYCC function for video sharpness
- | DLTI/DCTI/ Noise reduction for video quality

VividColor™

- | Independent color management (ICM)
- | Dynamic contrast control (DCC)

Output Interface

- | Fully programmable display timing generator
- | Flexible data pair swapping for easier system design.
- | Programmable TCON function support
- | 1 and 2 pixel/clock panel support and up to 170MHz, 1920/1440-pixel width(option)
- | Multi-output interface (LVDS/ TTL) on single PCB
- | Spread-Spectrum DPLL to reduce EMI
- | Fixed Last Line output for perfect panel capability

Embedded OSD

- | Embedded 16.5K SRAM dynamically stores OSD command and fonts
- | Support multi-color RAM font, 1, 2 and 4-bit per pixel
- | 16 color palette with 24bit true color selection
- | Maximum 8 window with alpha-blending/ gradient /dynamic fade-in/fade-out, bordering/ shadow/3D window type
- | Rotary 90,180,270 degree
- | Independent row shadowing/bordering
- | Programmable blinking effects for each character
- | OSD-made internal pattern generator for factory mode
- | Support 12x18~4x18 proportional font
- | Hardware decompression for OSD font
- | Special function for closed-caption and CGMS

Power & Technology

- | 3.3V / 1.8V power supply

(I/O Legend: A = Analog, I = Input, O = Output, P = Power, G = Ground)

Name	I/O	Pin #	Description	Note
VDD	AP	1	power	(3.3 V)
NC	AI	2	Not connected	Ref value: 1K ohm
V8_0	AI	3	Input/VIDEO 8-0	
V8_1	AI	4	Input/VIDEO 8-1	
V8_2	AI	5	Input/VIDEO 8-2	
V8_3	AI	6	Input/VIDEO 8-3	
V8_4	AI	7	Input/VIDEO 8-4	
V8_5	AI	8	Input/VIDEO 8-5	
V8_6	AI	9	Input/VIDEO 8-6	
V8_7	AI	10	Input/VIDEO 8-7	
GND	AG	11	ground	
NC	AI	12	Not connected	
NC	AI	13	Not connected	
NC	AI	14	Not connected	
NC	AI	15	Not connected	
NC	AI	16	Not connected	
NC	AI	17	Not connected	
NC	AI	18	Not connected	
NC	AI	19	Not connected	
VDD	AP	20	power	(3.3 V)
AVS0	I	21	ADC vertical sync input	no power 5V tolerance
AHS0	I	22	ADC horizontal sync input AVS0 and AHS0 could be used to select one of three scan chain. AHS0/AVS0: 2'b00: {i_chain[2:0], mcu_chain[1:0], vbi_chain[2:0]} 2'b01: d_chain 2'b10: vdec_chain Other are reserved	no power 5V tolerance
ADC_VDD	AG	23	ADC Power	(1.8V)
B0-	AI	24	Negative BLUE analog input (Pb-)	
B0+	AI	25	Positive BLUE analog input (Pb+)	
G0-	AI	26	Negative GREEN analog input (Y-)	
G0+	AI	27	Positive GREEN analog input (Y+)	
SOG0	AI	28	Sync-On-Green	
R0-	AI	29	Negative RED analog input (Pr-)	
R0+	AI	30	Positive RED analog input (Pr+)	
B1-/V8_7	AI	31	Negative BLUE analog input (Pb-)/VIDEO 8-7	
B1+/V8_6	AI	32	Positive BLUE analog input (Pb+)/VIDEO 8-6	
G1-/V8_5	AI	33	Negative GREEN analog input (Y-)/VIDEO 8-5	
G1+/V8_4	AI	34	Positive GREEN analog input (Y+)/VIDEO 8-4	
SOG1/V8_3	AI	35	Sync-On-Green/ VIDEO 3	
R1-/V8_2	AI	36	Negative RED analog input (Pr-)/VIDEO 8-2	
R1+/V8_1	AI	37	Positive RED analog input	

			(Pr+)/VIDEO 8-1	
ADC_GND/VADC_GND	AP	38	ADC/VADC GND	
AHS1/V8_0	I	39	ADC horizontal sync input/VIDEO 8-0	no power 5V tolerance
AVS1/VCLK	I	40	ADC horizontal sync input/VIDEO clock	no power 5V tolerance
Vin+0/V8_7	AI	41	Positive video analog input 0/VIDEO 8-7	
Vin-0/V8_6	AI	42	Negative video analog input 0/VIDEO 8-6	
Vin+1/V8_5	AI	43	Positive video analog input 1/VIDEO 8-5	
Vin-1/V8_4	AI	44	Negative video analog input 1/VIDEO 8-4	
Vin+2/V8_3	AI	45	Positive video analog input 2/VIDEO 8-3	
Vin-2/V8_2	AI	46	Negative video analog input 2/VIDEO 8-2	
Vin+3/V8_1	AI	47	Positive video analog input 3/VIDEO 8-1	
Vin-3/V8_0	AI	48	Negative video analog input 3/VIDEO 8-0	
VADC_VDD	AG	49	Video decoder ADC POWER	(3.3V)
A-ADC0/GPIO/AVOUT/VCLK	IO	50	MCU ADC Input /MCU GPIO/AVOUT/VIDEO clock	
A-ADC1/GPIO	IO	51	6-bit MCU ADC Input/MCU GPIO	6 bit
A-ADC2/GPIO	IO	52	6-bit MCU ADC Input /MCU GPIO	6 bit
A-ADC3/GPIO	IO	53	6-bit MCU ADC Input/MCU GPIO	6 bit
A-ADC4/GPIO	IO	54	6-bit MCU ADC Input /MCU GPIO	6 bit
B-ADC0/GPIO/PWM1/PWM5	IO	55	10-bit MCU ADC Input/MCU GPIO/PWM	10 bit
B-ADC1/GPIO/IIC SCL	IO	56	10-bit MCU ADC Input /MCU GPIO/IIC BUS	10 bit
B-ADC2/GPIO/IIC SDA	IO	57	10-bit MCU ADC Input/MCU GPIO/IIC BUS	10 bit
DDCSCL1/GPIO	IO	58	DDC1(pen drain I/O)/MCU GPIO	No power 5V tolerance
DDCSDA1/GPIO	IO	59	DDC1(Open drain I/O)/MCU GPIO	No power 5V tolerance
VCKK	P	60	Digital Power	(1.8V)
GNDK	G	61	Digital Ground	
PVCC	P	62	Pad power	3.3V
NC	--	63	Not connected	
SD0/SPDIF0/TCON[0]/GPIO/IrDA	IO	64	IIS-SD0 /SPDIF0 / TCON /MCU GPIO/ Infrared remote data pin	
WS/GPIO/TCON[7][1]/PWM1	IO	65	IIS-WS /MCU GPIO / TCON /PWM	
SCK/TCON[4][2]/GPIO/BLU7	IO	66	IIS-SCK / TCON /MCU GPIO/TTL Data Bus	
MCK/TCON[5][9]/GPIO/BLU6	IO	67	IIS-MCK / TCON /MCU GPIO/TTL Data Bus	
SD0/SPDIF0/TCON[13][3]/GPIO/BLU5	IO	68	IIS-SD0 /SPDIF0 / TCON /MCU GPIO/TTL Data Bus	
SPDIF1/SD1/TCON[7][3]/GPIO/IIC SCL/BLU4	IO	69	SPDIF1 /IIS-SD1 / TCON /MCU GPIO/IIC BUS /TTL Data Bus	
SPDIF2/SD2/TCON[9][1]	IO	70	SPDIF2 /IIS-SD2 / TCON /MCU	

1]/GPIO/IICSDA/BLU3			GPIO/IIC bus/TTL Data Bus	
SPDIF3/SD3/TCON[10][8]/GPIO/PWM1/PWM5/BLU2	IO	71	SPDIF3 / IIS-SD3 / TCON /MCU GPIO/PWM /TTL Bata Bus	
NC	--	72	Not connected	
VCCK	P	73	Digital Power	(1.8V)
BLU7/BLU1/TXO3+ /GPIO	IO	74	TTL Data Bus(BLU7,BLU1)/LVDS /MCU GPIO	
BLU6/BLU0/TXO3- /GPIO	IO	75	TTL Data Bus(BLU6,BLU0)/LVDS /MCU GPIO	
BLU5/GRN7/TXOC+ /GPIO	IO	76	TTL Data Bus(BLU5,BLU7)/LVDS/MCU GPIO	
BLU4/GRN6/TXOC- /GPIO	IO	77	TTL Data Bus(BLU4,BLU6)/LVDS/MCU GPIO	
BLU3/GRN5/TXO2+ /GPIO	IO	78	TTL Data Bus(BLU3,BLU5)/LVDS/MCU GPIO	
BLU2/GRN4/TXO2- /GPIO	IO	79	TTL Data Bus(BLU2,BLU4)/LVDS/MCU GPIO	
GRN7/GRN3/TXO1+ /GPIO	IO	80	TTL Data Bus(GRN7,GRN3)/LVDS/MCU GPIO	
GRN6/GRN2/TXO1- /GPIO	IO	81	TTL Data Bus(GRN6,GRN2)/LVDS/MCU GPIO	
GRN5/GRN1/TXO0+ /GPIO	IO	82	TTL Data Bus(GRN5,GRN1)/LVDS/MCU GPIO	
GRN4/GRN0/TXO0- /GPIO	IO	83	TTL Data Bus(GRN4,GRN0)/LVDS/MCU GPIO	
PVCC	P	84	Pad power	3.3V
PGND	G	85	Pad ground	
GRN3/RED7/TXE3+	O	86	TTL Data Bus(GRN3,RED7)/LVDS	
GRN2/RED6/TXE3-	O	87	TTL Data Bus(GRN2,RED6)/LVDS	
RED7/RED5/TXEC+	O	88	TTL Data Bus(RED7,RED5)/LVDS	
RED6/RED4/TXEC-	O	89	TTL Data Bus(RED6,RED4)/LVDS	
RED5/RED3/TXE2+	O	90	TTL Data Bus(RED5,RED3)/LVDS	
RED4/RED2/TXE2-	O	91	TTL Data Bus(RED4,RED2)/LVDS	
RED3/RED1/TXE1+	O	92	TTL Data Bus(RED3,RED1)/LVDS	
RED2/RED0/TXE1-	O	93	TTL Data Bus(RED2,RED0)/LVDS	
TXE0+/DENA	O	94	LVDS/TTL Data enable	
TXE0-/DHS	O	95	LVDS/TTL Display H-sync	
GPIO/PWM0/DCLK	IO	96	MCU GPIO/PWM/TTL Display clock	No power 5V tolerance
GPIO/PWM1/DVS	IO	97	MCU GPIO/PWM/TTL Display V-sync	No power 5V tolerance
GPIO/PWM2	IO	98	MCU GPIO/PWM	No power 5V tolerance
GPIO/PWM3/TCON[11][6]	IO	99	MCU GPIO/PWM/TCON	No power 5V tolerance
GPIO/PWM4/TCON[12][3]	IO	100	MCU GPIO/PWM/TCON	No power 5V tolerance
GPIO/PWM5/TCON[0]	IO	101	MCU GPIO/PWM/TCON	No power 5V tolerance
SD3/SPDIF3/TCON[10]/GPIO/PWM0	IO	102	IIS-SD3/SPDIF3/TCON/MCU GPIO/ PWM	No power 5V tolerance
SD2/SPDIF2/TCON[8]/GPIO/IICSCS/PWM1	IO	103	IIS-SD2/SPDIF2/TCON[8]/MCU GPIO/IICSCS/PWM1	No power 5V tolerance
SD1/SPDIF1/TCON[5]/G	IO	104	IIS-SD1/SPDIF1/TCON[5]/MCU	No power 5V

PIO/IRQB/IICSDA			GPIO/IRQ Bar/IICSDA	tolerance
SD0/SPDIF0/TCON[9]/GPIO	IO	105	IIS-SD0/SPDIF0/TCON/MCU GPIO	No power 5V tolerance
PVCC	P	106	Pad 3.3V power	3.3V
PGND	P	107	Pad 3.3V GND	
MCK/TCON[7]/GPIO	IO	108	IIS-MCK/TCON/MCU GPIO	No power 5V tolerance
SCK/TCON[3]/GPIO	IO	109	IIS-SCK/TCON/MCU GPIO	No power 5V tolerance
WS/TCON[6]/GPIO	IO	110	IIS-WS/TCON/MCU GPIO	No power 5V tolerance
SD0/SPDIF0/TCON[4]/GPIO	IO	111	IIS-SD0/SPDIF0/TCON/MCU GPIO	No power 5V tolerance
SD1/SPDIF1/TCON[9]/GPIO	IO	112	IIS-SD1/SPDIF1/TCON/MCU GPIO	No power 5V tolerance
SD2/SPDIF2/TCON[1]/GPIO/IrDA	IO	113	IIS-SD2/SPDIF2/TCON/MCU GPIO/Infrared remote data pin	No power 5V tolerance
SD3/SPDIF3/TCON[13]/GPIO/VCLK	IO	114	IIS-SD3/SPDIF3/TCON/MCU GPIO/VIDEO 8-clock	No power 5V tolerance
SPL_SCLK/SDIO	IO	115	SPI flash serial data input/external MCU serial control I/F data in	No power 5V tolerance
SI/MCU_SCLK	IO	116	SPI flash serial clock/external MCU serial control I/F clock	No power 5V tolerance
SO/SCSB	IO	117	SPI flash serial data output /external MCU serial control I/F chip select	No power 5V tolerance
CEB/IRQB	IO	118	SPI flash chip enable bar/IRQ Bar Note:It should be pulled down to 0 v or pulled up to 3.3 v in order to designate the MCU type(Internal MCU(0 volts) or External MCU(3.3 volts)).	No power 5V tolerance
NC	--	119	Not connected	
VCCK	P	120	Digital 1.8V Power	1.8V
DDCSCL3/GPIO	IO	121	DDC3(Open drain I/O)/MCU GPIO	No power 5V tolerance
DDCSDA3/GPIO	IO	122	DDC3(Open drain I/O)/MCU GPIO	No power 5V tolerance
DDCSDA2/GPIO	IO	123	DDC2(Open drain I/O)/MCU GPIO	No power 5V tolerance
DDCSCL2/GPIO	IO	124	DDC2(Open drain I/O)/MCUGPIO	No power 5V tolerance
RESETB	I	125	Chip Reset Bar	Low active; No power 5V tolerance
CEC	I/O	126	CEC bus	Pull up 27k ohm resistance to 3.3V power; No power 5V tolerance
XO	AO	127	Crystal Output	No power 5V tolerance
XI	AI	128	Crystal Input	No power 5V

				tolerance
--	--	--	--	-----------

MCU GPIO assignment

PIN No.	MCU GPIO Name
50	P6.0
51	P6.1
52	P6.2
53	P6.3
54	P6.4
55	P6.5

56	P6.6
57	P6.7
58	P3.0/RXD(I/O)
59	P3.1/TXD(O)
64	P1.0/T2(I)
65	P1.1/T2EX(I)
66	P1.2/CLKO2(O)
67	P1.3
68	P1.4
69	P1.5
70	P1.6
71	P1.7
74	P9.0
75	P9.1
76	P9.2
77	P9.3
78	P9.4
79	PA.0
80	PA.1
81	PA.2
82	PA.3
83	PA.4
94	P5.0 (removed)
95	P5.1 (removed)
96	P5.2
97	P5.3
98	P5.4
99	P5.5
100	P5.6
101	P5.7
102	P7.6
103	P7.5
104	P7.4
105	P8.0
108	P8.1/CLKO1(O)

109	P3.2/INT0(I)
110	P3.3/INT1(I)
111	P3.4/T0
112	P3.5(BS)/T1
113	P3.6
114	P3.7
121	P7.3
122	P7.2
123	P7.1

Realtek Confidential for GM Only

2. Chip Data Path Block Diagram

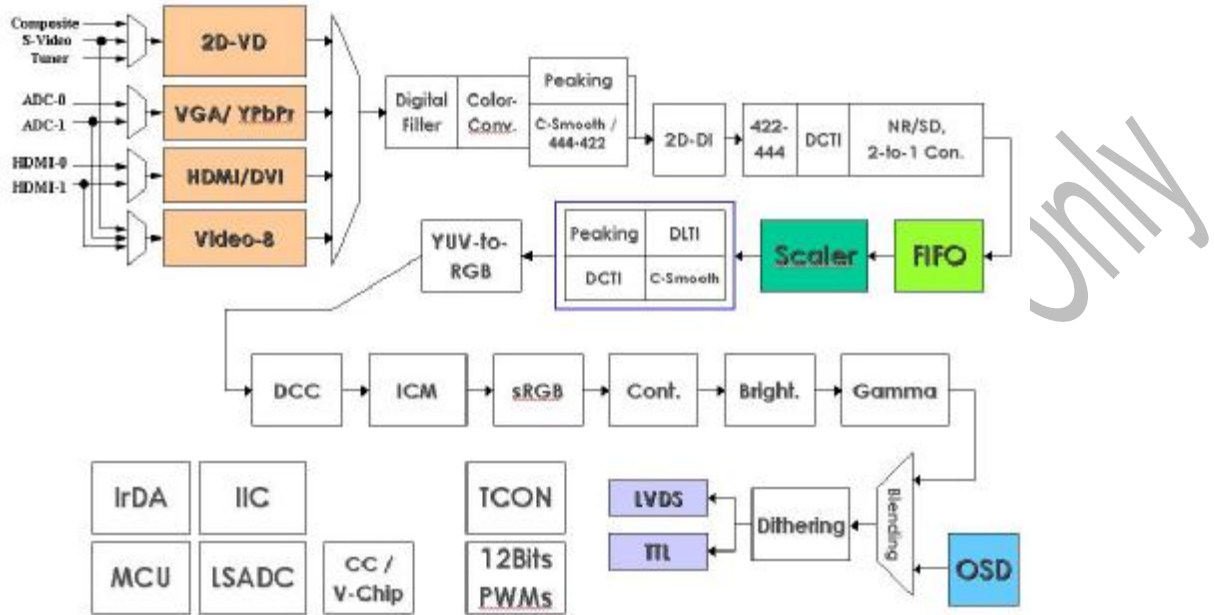

Figure 1

3. Register Description

Common page Global Event Flag

Register::ID_Reg					0x00
Name	Bit	R/W	Default	Description	Config
ID	7:0	R	0xf1	MSB 4 bits: 1111 product code LSB 4 bits: 0001rev. code	

Register:: Host_ctrl					0x01
Name	Bit	R/W	Default	Description	Config.
Rev	7	---	0	Reserved	
Reset_chk	6	R/W	0	Reset Check Once scalar is reset, this value will be cleared to 0. The purpose of it is to check if LVR has been triggered. It should be written to 1 ahead, then read it. LVR has been triggered if the value is 0, else LVR has not.	
Rev	5:3	---	---	Reserved	
PD_EN	2	R/W	0	Power Down Mode Enable 0: Normal (Default) 1: Enable power down mode Turn off ADC RGB Channel/ ADC Band-gap/ SOG/ DPLL/ LVDS/ ADC PLL/ SYNC- PROC/ AUTO SOY ADC/VADC/m2pll	
PS_EN	1	R/W	1	Power Saving Mode Enable 0: Normal 1: Enable power saving mode (Default) Turn off ADC RGB channel/ DPLL/ LVDS/ ADC PLL/VADC / m2pll When power down or power saving function is enabled, internal mcu clock is forced to crystal clock.	
Sft_Reset	0	R/W	0	Software Reset Whole Chip (Low pulse at least 8ms) 0: Normal (Default) 1: Reset	

				All registers are reset to default except HOST_CTRL and power-on-latch.	
--	--	--	--	---	--

Register:: STATUS0				0x02	
Name	Bit	R/W	Default	Description	Config.
ADCPLL_nonlock	7	R	0	ADC_PLL Non-Lock If the ADC_PLL non-lock occurs, this bit is set to "1".	
IVS_error	6	R	0	Input VSYNC Error If the input vertical sync occurs within the programmed active period, this bit is set to "1".	
IHS_error	5	R	0	Input HSYNC Error If the input horizontal sync occurs within the programmed active period, this bit is set to "1".	
ODD_Occur	4	R	0	Input ODD Toggle Occur (For internal field odd toggle, refer to CR1A[5]) If the ODD signal (From SAV/EAV or V16_ODD) toggle occurs, this bit is set to "1".	
V8HV_Occur	3	R	0	Video8/16 Input Vertical/Horizontal Sync Occurs If the YUV input V or H sync edge occurs, this bit is set to "1".	
ADCHV_Occur	2	R	0	ADC Input Vertical/Horizontal Sync Occurs Input V or H sync edge occurs; this bit is set to "1".	
Buffer_Ovf1	1	R	0	Input Overflow Status (Frame Sync Mode) * ¹ If an overflow in the input data capture buffer occurs, this bit is set to "1".	
Buffer_Udf1	0	R	0	Line Buffer Underflow Status (Frame Sync Mode) If an underflow in the line-buffer occurs, this bit is set to "1".	

Write to clear status.

*¹Only first event of input overflow/underflow is recorded if both of them occurs.

Register:: STATUS1					0x03
Name	Bit	R/W	Default	Description	Config.
Buffer_Ovf2	7	R	0	Line Buffer Overflow Status 1: Line Buffer overflow has occurred since the last status cleared	
Buffer_Udf2	6	R	0	Line Buffer Underflow Status 1: Line Buffer underflow has occurred since the last status cleared	
DENA_Stop	5	R	0	DENA Stop Event Status 1: If the DENA stop event occurred since the last status cleared	
DENA_Start	4	R	0	DENA Start Event Status 1: If the DENA start event occurred since the last status cleared as an interrupt source	
DVS_Start	3	R	0	DVS Start Event Status 1: If the DVS start event occurred since the last status cleared	
IENA_Stop	2	R	0	IENA Stop Event Status 1: If the IENA stop event occurred since the last status cleared	
IENA_Start	1	R	0	IENA Start Event Status 1: If the IENA start event occurred since the last status cleared	
IVS_Start	0	R	0	IVS Start Event Status 1: If the IVS start event occurred since the last status cleared	

Write to clear status.

Register::IRQ_CTRL0					0x04
Name	Bit	R/W	Default	Description	Config.
IRQ_EN	7	R/W	0	Internal IRQ Enable: (Global) 0: Disable these interrupt. 1: Enable these interrupt.	
IRQ_ADCPLL	6	R/W	0	IRQ (ADC_PLL Non-Lock) 0: Disable the ADC_PLL non-lock error event as an interrupt source 1: Enable the ADC_PLL non-lock error event as an interrupt source	
IRQ_IHV	5	R/W	0	IRQ (Input VSYNC/HSYNC Error) (DEN across Vsync or Hsync) 0: Disable the Input VSYNC/HSYNC	

				error event as an interrupt source 1: Enable the Input VSYNC/HSYNC error event as an interrupt source	
IRQ_ODD	4	R/W	0	IRQ (Input ODD Toggle Occur) (EAV/SAV from Video8/16 or V16_ODD) 0: Disable Input ODD toggle event as an interrupt source 1: Enable the Input ODD toggle event as an interrupt source	
IRQ_V8_HV	3	R/W	0	IRQ (Video8/16 Input Hsync/Vertical Sync Occurs) 0: Disable the Video8/16 Input Hsync or Vsync event as an interrupt source 1: Enable the Video8/16 Input Hsync or Vsync event as an interrupt source	
IRQ_ADC_HV	2	R/W	0	IRQ (ADC Input Hsync/Vertical Sync Occurs) 0: Disable the ADC Input Hsync or Vsync event as an interrupt source 1: Enable the ADC Input Hsync or Vsync event as an interrupt source	
IRQ_Buffer	1	R/W	0	IRQ (Line Buffer Underflow/Overflow Status) 0: Disable the Line Buffer underflow/overflow event as an interrupt source 1: Enable the Line Buffer underflow/overflow event as an interrupt source	
IRQ_IENA	0	R/W	0	IRQ (Input ENA Start Event Occurred Status) 0: Disable IENA start as interrupt source 1: Enable IENA start as interrupt source	

Register:: New_added_status0					0x07
Name	Bit	R/W	Default	Description	Config.
Wstate	7	R	---	Wait state status	

New_m_state	6	R	---	New mode state	
Change_m_happen	5	R	---	Change mode happen (it will not be triggered while VGIP active signal is low)	
Wstate_IRQ_en	4	R/W	0	IRQ enable of Wait state status 0:disable 1:enable	
New_m_state_IRQ_en	3	R/W	0	IRQ enable of New mode status 0:disable 1:enable	
Change_m_happen_IRQ_en	2	R/W	0	IRQ enable of change mode happen status 0:disable 1:enable	
VD_IRQ	1	R	---	VD IRQ status	
VBI_Statua	0	R	---	VBI status	

Register:: New_added_status1					0x08
Name	Bit	R/W	Default	Description	Config.
SOY0_status	7	R	---	Auto SOY0 one time measure status	
SOY1_status	6	R	---	Auto SOY1 one time measure status	
Reserved	5:0	---	---	Reserved	

Address: 09~0B Reserved

Watch Dog

Address: 0C

WATCH_DOG_CTRL0

Default: 00h

Bit	Mode	Function
7	R/W	Auto Switch When Input HSYNC/VSYNC Error 0: Disable (Default) 1: Enable (See CR02[6] and CR02[5])
6	R/W	Auto Switch When Input HSYNC/VSYNC Timeout or Overflow 0: Disable (Default) 1: Enable (See CR52[4] and CR54[5:4])
5	R/W	Auto Switch When Display VSYNC Timeout 0: Disable (Default) 1: Enable
4	R/W	Auto Switch When ADC-PLL Unlock 0: Disable (Default) 1: Enable
3	R/W	Auto Switch When Overflow or Underflow (for Frame-Sync Display) 0: Disable (Default)

		1: Enable
2	R/W	Watch-Dog Action if Event Happened (for Display Timing) 0: Disable (Default) 1: Free Run
1	R/W	Watch-Dog Action if Event Happened (for Display Data) 0: Disable (Default) 1: Background (Turn off overlay function and switch to background display simultaneously)
0	R	Display VSYNC Timeout Flag (for CR0C[5]) 0: DVS is present 1: DVS is timeout The line number of Display HS is equal to Display Vertical Total; this bit is set to "1". (Write to clear status).

Address: 0D
WATCH_DOG_CTRL1
Default: 00h

Bit	Mode	Function
7	R/W	Auto Switch When Input HSYNC Changed 0: Disable (Default) 1: Enable (See CR58[3])
6	R/W	Auto Switch When Input VSYNC Changed 0: Disable (Default) 1: Enable (See CR58[2])
5	R/W	Wstate WD enable 0:Disable(Default) 1:enable
4	R/W	New_m_state 0:Disable(Default) 1:enable
3	R/W	Change_mode_happen 0:Disable(Default) 1:enable
2:0	---	Reserved

Address: 0E~0F Reserved

Input Video Capture

Address: 10 **VGIP_CTRL (Video Graphic Input Control Register)** **Default: 00h**

Bit	Mode	Function														
7	R/W	8 bit Random Generator 0: Disable(Default) 1: Enable														
6	R/W	Input Test Mode: 0: Disable (Default) 1: Video8 input will go through RGB channel, AVS=>IVS, AHS=>IHS, VCLK=>ICLK														
5	R/W	VGIP Double Buffer Ready 0: Not Ready to Apply 1: Ready to Apply When the list table of CR10[4] is set, then enable CR10[5] . Remember to set CR13[3] to decide which one condition to use. Finally, hardware will auto load these values into VGIP double buffer registers as the trigger event happens and clear CR10[5] to 0.														
4	R/W	VGIP Double Buffer Mode Enable (Each register described below has its own double buffer) 0: Disable (Original- Write instantly by MCU write cycles) 1: Enable (Double Buffer Function Write Mode)														
		<table border="1"> <thead> <tr> <th>Register</th> <th>Trigger Event</th> </tr> </thead> <tbody> <tr> <td>PLLPHASE(CRB3,CRB4) Add 1-clk Delay to IHS Delay (CR12[4]) HSYNC Synchronize Edge (CR12[3])</td> <td>Falling edge of Ivactive</td> </tr> <tr> <td>IPH_ACT_STA (CR14[2:0],CR15)</td> <td>Falling edge of Ivactive</td> </tr> <tr> <td>IPV_ACT_STA (CR18[2:0],CR19) IV_DV_LINES (CR40)</td> <td>Falling edge of Ivactive</td> </tr> <tr> <td>IVS_DELAY (for capture) (CR1C,CR1E[1])</td> <td>Falling edge of Ivactive</td> </tr> <tr> <td>IHS_DELAY (for capture) (CR1D, CR1E[0])</td> <td>Falling edge of Ivactive</td> </tr> <tr> <td>IPH_PORCH_NUM (CR1F[2:0],CR20)</td> <td>Falling edge of Ivactive</td> </tr> </tbody> </table>	Register	Trigger Event	PLLPHASE(CRB3,CRB4) Add 1-clk Delay to IHS Delay (CR12[4]) HSYNC Synchronize Edge (CR12[3])	Falling edge of Ivactive	IPH_ACT_STA (CR14[2:0],CR15)	Falling edge of Ivactive	IPV_ACT_STA (CR18[2:0],CR19) IV_DV_LINES (CR40)	Falling edge of Ivactive	IVS_DELAY (for capture) (CR1C,CR1E[1])	Falling edge of Ivactive	IHS_DELAY (for capture) (CR1D, CR1E[0])	Falling edge of Ivactive	IPH_PORCH_NUM (CR1F[2:0],CR20)	Falling edge of Ivactive
Register	Trigger Event															
PLLPHASE(CRB3,CRB4) Add 1-clk Delay to IHS Delay (CR12[4]) HSYNC Synchronize Edge (CR12[3])	Falling edge of Ivactive															
IPH_ACT_STA (CR14[2:0],CR15)	Falling edge of Ivactive															
IPV_ACT_STA (CR18[2:0],CR19) IV_DV_LINES (CR40)	Falling edge of Ivactive															
IVS_DELAY (for capture) (CR1C,CR1E[1])	Falling edge of Ivactive															
IHS_DELAY (for capture) (CR1D, CR1E[0])	Falling edge of Ivactive															
IPH_PORCH_NUM (CR1F[2:0],CR20)	Falling edge of Ivactive															
3:2	R/W	Input Pixel Format 00: Embedded ADC (ADC_HS)(Default) 01: Reserved 10: Video8 11: Video Decoder Input(Video 16)														
1	R/W	Input Graphic/Video Mode 0: From analog input (input captured by 'Input Capture Window') (Default)														

		1: From digital input (captured start by 'enable signal', but sill stored in 'capture window size')
0	R/W	Input Sampling Run Enable 0: No data is transferred (Default) 1: Sampling input pixels

Address: 11 **VGIP_SIGINV (Input Control Signal Inverted Register)** **Default: 00h**

Bit	Mode	Function
7	R/W	Safe Mode 0: Normal (Default) 1: Safe Mode Enable, mask 1 frame IVS of every 2 frame IVS, slow down input frame rate.
6	R/W	IVS Sync with IHS Control (Avoid VS bouncing) 0: Enable (Default) 1: Disable
5	R/W	HS Signal Inverted for Field Detection 0: Negative Edge (Default) 1: Positive Edge
4	R/W	Input Video ODD Signal Invert Enable 0: Not inverted (ODD = positive polarity) (Default) 1: Inverted (ODD = negative polarity)
3	R/W	Input VS Signal Polarity Inverted 0: Not inverted (VS = positive polarity) (Default) 1: Inverted (VS = negative polarity)
2	R/W	Input HS Signal Polarity Inverted 0: Not inverted (HS = positive polarity) (Default) 1: Inverted (HS = negative polarity)
1	R/W	Input ENA Signal Polarity Inverted 0: Not inverted (input high active) (Default) 1: Inverted (while input low active)
0	R/W	Video Input Clock Polarity 0: Rising edge latched (Default) 1: Falling edge latched

Address: 12 **VGIP_DELAY_CTRL** **Default: 00h**

Bit	Mode	Function
7	R	6-Iclk-delay HS Level Latched by VS Rising Edge
6	R	HS Level Latched by VS Rising Edge
5	R	HS Level Latched by 6-Iclk-delay VS Rising Edge
4	R/W/D	Add One Clock Delay to IHS Delay

		0: Disable (Default) 1: Enable
3	R/W/D	HSYNC Synchronize Edge 0: HSYNC is synchronized by the positive edge of the input clock 1: HSYNC is synchronized by the negative edge of the input clock (HSYNC source is selected by CR48[0] and then synchronized)
2	R/W	VSYNC Synchronize Edge 0: Latch VS by the negative edge of input HSYNC (Default) 1: Latch VS by the positive edge of input HSYNC
1:0	R/W	Video Input Clock Delay Control: 00: Normal (Default) 01: 1ns delay 10: 2ns delay 11: 3ns delay

Address: 13 **VGIP_ODD_CTRL (Video Graphic Input ODD Control Register) Default: 00h**

Bit	Mode	Function
7	R/W	ODD Inversion for ODD-Controlled-IVS-Delay 0: Not Invert (Default) 1: Invert
6	R/W	ODD-Controlled-IVS-Delay One-Line Enable 0: Disable (Default) 1: Enable (Both for Auto and Capture)
5	R/W	Safe Mode ODD Inversion 0: Not inverted (Default) 1: Inverted
4	R/W	Force ODD Toggle Enable (Without ODD/EVEN Toggle Select in Safe Mode) 0: Disable (Default) 1: Enable
3	R/W	VGIP Double Buffer Condition Select Depends on which one signal to decide that VGIP Double Buffer write into registers really. 0: module SDNR v_active end pulse (Default) 1: module VGIPMAIN v_active end pulse (This bit should be always valid only while VGIP Double Buffer Mode Enable CR10[4] is enable and VGIP Double Buffer Ready CR10[5] is apply.)

2	R/W	VGIP 1x 2x Clock Sel 0: 1x => Non interlaced source (default) 1: 2x => For interlaced source
1	R/W	EAV Error Correction Enable in Video-8/Video-16 0: Disable 1: Enable
0	R/W	Internal ODD Signal Selection 0: ODD signal from EAV or YPbPr (Default) 1: Internal Field Detection ODD signal (Also support under VGA input)

Realtek Confidential for GM Only

Input Frame Window

(All capture window setting unit is 1)

Address: 14 **IPH_ACT_STA_H (Input Horizontal Active Start)** **Default: 00h**

Bit	Mode	Function
7:3	R/W	Reserved
2:0	R/W/D	Input Video Horizontal Active Start -- High Byte [10:8]

Address: 15 **IPH_ACT_STA_L (Input Horizontal Active Start Low)** **Default: 00h**

Bit	Mode	Function
7:0	R/W/D	Input Video Horizontal Active Start -- Low Byte [7:0]

- I In analog mode, **IPH_ACT_STA** means the delay number of pixel clock from the leading edge of HS to the first pixel of each active line. Actual delay number of pixel clock = **IPH_ACT_STA**(≥ 2) + 2,
- I In digital mode, **IPH_ACT_STA** means the delay number of pixel clock from the leading edge of DE to the first pixel of each active line. Actual delay number of pixel clock = **IPH_ACT_STA**(≥ 0)

Address: 16 **IPH_ACT_WID_H (Input Horizontal Active Width High)** **Default: 00h**

Bit	Mode	Function
7	R/W	Video8 -C-Port Input Latch Bus MSB to LSB Swap Control: 0: Normal (Default) 1: Swap Video8 -C-port MSB to LSB sequence into LSB to MSB
6	R/W	ADC Input G/B Swap 0: No Swap 1: Swap
5	R/W	ADC Input R/B Swap 0: No Swap 1: Swap
4	R/W	ADC Input R/G Swap 0: No Swap 1: Swap
3	R/W	Video8 switch 0: Video8(Default) 1: Reserved
2:0	R/W	Input Video Horizontal Active Width – High Byte [10:8]

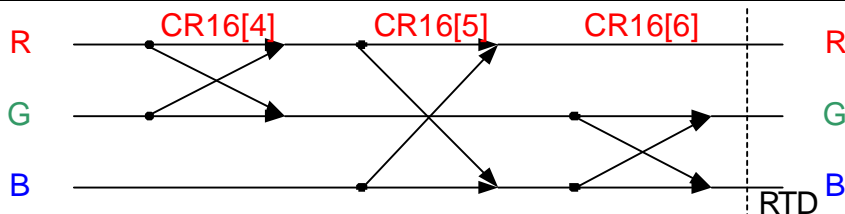

Address: 17 **IPH_ACT_WID_L (Input Horizontal Active Width Low)** **Default: 00h**

Bit	Mode	Function
7:0	R/W	Input Video Horizontal Active Width -- Low Byte [7:0]

This register defines the number of active pixel clocks to be captured.

Address: 18 **IPV_ACT_STA_H (Input Vertical Active Start High)** **Default: 00h**

Bit	Mode	Function
7:6	R/W	Video 8 source sel 00: reserved 01: from ADC 10: from Video decoder 11: reserved
5	R/W	Video16 Y/C Port Swap Function 0: Disable Video16 Y/C Port Swap 1: Enable Video16 Y/C Port Swap
4	R/W	Video8 / Video16 Select 0: Video8 1: Video16
3	R/W	Video16-Y-port Input Latch Bus MSB to LSB Control: 0: Normal (Default) 1: Swap Video16-Y-port MSB to LSB sequence into LSB to MSB
2:0	R/W/D	Input Video Vertical Active Start – High Byte [10:8]

Address: 19 **IPV_ACT_STA_L (Input Vertical Active Start Low)** **Default: 00h**

Bit	Mode	Function
7:0	R/W/D	Input Video Vertical Active Start – Low Byte [7:0]

The numbers of lines from the leading edge of selected input video VSYNC to the first line of the active window.

The value above should be larger than 1.

Address: 1A **IPV_ACT_LEN_H (Input Vertical Active Lines)** **Default: 00h**

Bit	Mode	Function
7	R	SAV/EAV 2-Bit Error Happened (Set if happened and write to clear)
6	R	SAV/EAV 1-Bit Error Happened (Set if happened and write to clear)
5	R	Internal Field Detection ODD Toggle Happened (Set if happened and write to clear) The function should be worked under no input clock
4:3	R	Number of Input HS between 2 Input VS (LSB bit [1:0])
2:0	R/W	Input Video Vertical Active Lines – High Byte [10:8]

Address: 1B **IPV_ACT_LEN_L (Input Vertical Active Lines)** **Default: 00h**

Bit	Mode	Function
7:0	R/W	Input Video Vertical Active Lines – Low Byte [7:0]

This register defines the number of active lines to be captured.

Address: 1C **IVS_DELAY (Internal Input-VS Delay Control Register)** **Default: 00h**

Bit	Mode	Function
7:0	R/W/D	Input VSYNC Delay for Capture[7:0] (Counted by Input HSYNC) It's IVS delay for capture and digital filter, not for auto function

Address: 1D **IHS_DELAY (Internal Input-HS Delay Control Register)** **Default: 00h**

Bit	Mode	Function
7:0	R/W/D	Input HSYNC Delay for Capture [7:0] (Counted by Input Pixel Clock) It's IHS delay for capture and digital filter, not for auto function

Address: 1E **VGIP_HV_DELAY** **Default: 00h**

Bit	Mode	Function
7:6	R/W	Input HSYNC Delay for Auto Function (Counted by Input Pixel Clock) 00: No delay 01: 32 pixels 10: 64 pixels 11: 96 pixels
5:4	R/W	Input VSYNC Delay for Auto Function (Counted by Input HSYNC) 00: No delay 01: 3 line 10: 7 line 11: 15 line
3:2	R/W	VBI clock source 0: PLL27x 1: YPbPr 2x clock 2: YPbPr 1x clock 3: Reserved
1	R/W/D	Input VSYNC Delay for Capture[8] (Counted by Input HSYNC)
0	R/W/D	Input HSYNC Delay for Capture[8] (Counted by Input Pixel Clock)

Address: 1F **IPH_PORCH_NUM_H (Input Horizontal Porch number)** **Default: 00h**

Bit	Mode	Function
7	R	VGIP field 0: even

		1:odd
6:5	---	Reserved
4	R/W	Video decoder vsync select 0:video vsync 1:video v-active_negative
3	R/W	I2D_SRC_SEL: IVS to DVS, IHS to DHS Source Select 0: 0: Using SDNR output IVS/IHS/Field as source (Default) 1: Using VGIP hvs_dly output IVS/IHS/Field as source
2:0	R/W/D	Input Video Horizontal PORCH NUM -- High Byte [10:8]

Address: 20 **IPH_PORCH_NUM_L (Input Horizontal Porch number)** **Default: 80h**

Bit	Mode	Function
7:0	R/W/D	Input Video Horizontal PORCH NUM -- High Byte [7:0]

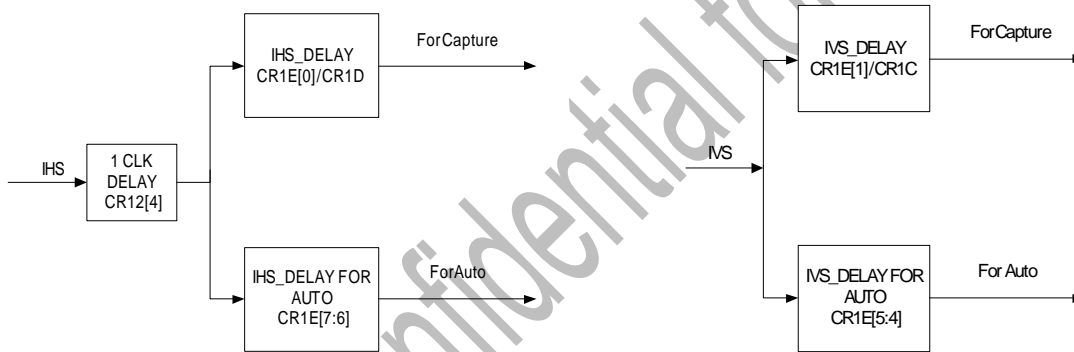

Figure 15: Input HSYNC/VSYNC Delay Path Diagram

FIFO Frequency

Address: 22 **FIFO Frequency** **Default: 00h**

Bit	Mode	Function
7	R/W	Test Mode 0: Disable 1: Input data of VGIP Replaced by Background Color in CR6D
6:3	R/W	Reserved to 0
2	R/W	Internal Xtal Frequency 0: Fxtal 1: Fxtal * M2PLL_M / M2PLL_N / 10
1:0	R/W	FIFO Frequency 00: M2PLL

		01: ICLK 10: DCLK 11: Test clock
--	--	--

Input pattern generator
Address: 23 **FIFO_BIST_CTRL (FIFO BIST Control Register)** **Default: 00h**

Bit	Mode	Function
7	R	Bist for FiFo ok 0: Fail 1: Ok
6	---	Reserved
5	R/W	Fifo Bist Function Start (Auto clear to 0 when finish) 0: Finish 1: Start
4:0	---	Reserved

Address: 24 **Input Pattern Generator_Access_Port Control** **Default:00h**

Bit	Mode	Function
7	R/W	Enable Input_Pattern_Generator access port by CR25
6:5	--	Reserved to 0
4:0	R/W	Input Pattern_Generator port address in CR25

Address: 25-10 **Input Pattern Generator Ctrl 0** **Default: 8'h00**

Bit	Mode	Function
7	R/W	Pattern reset to initial value 0 : 1 frame 1 : 16 frame
6	R/W	Random generator mode 0 : $x^7 + x^4 + x^3 + x^2 + 1$ 1 : $x^{24} + x^4 + x^3 + x^1 + 1$ (Green, Blue, Red)
5	R/W	Data update (RED) 0 : reference data enable(pixel base) 1: reference horizontal data enable end(line base)
4	R/W	Data update (GREEN) 0 : reference data enable 1: reference horizontal data enable end
3	R/W	Data update (BLUE) 0 : reference data enable 1: reference horizontal data enable end
2	R/W	Pattern generator mode (RED) 0 : random generator (ref. CR25-10[6]) 1 : pattern generator (reg. CR25-11[2])
1	R/W	Pattern generator mode (GREEN) 0 : random generator (ref. CR25-10[6]) 1 : pattern generator (reg. CR25-11[1])
0	R/W	Pattern generator mode (BLUE) 0 : random generator (ref. CR25-10[6])

		1 : pattern generator (reg. CR25-11[0])
--	--	---

Address: 25-11 Input Pattern Generator Ctrl 1 **Default: 8'h00**

Bit	Mode	Function
7-3	R/W	Reserved to 0
2	R/W	Pattern generator (RED) 0 : Out(n) = Out(n-1) 1: Out(n) = Out(n-1) + 1
1	R/W	Pattern generator (GREEN) 0 : Out(n) = Out(n-1) 1: Out(n) = Out(n-1) + 1
0	R/W	Pattern generator (BLUE) 0 : Out(n) = Out(n-1) 1: Out(n) = Out(n-1) + 1

Address: 25-12 Input Pattern Generator RED Initial Value **Default: 8'h01**

Bit	Mode	Function
7-0	R/W	RED Initial Value [7:0]

Address: 25-13 Input Pattern Generator GREEN Initial Value **Default: 8'h01**

Bit	Mode	Function
7-0	R/W	Green Initial Value [7:0]

Address: 25-14 Input Pattern Generator BLUE Initial Value **Default: 8'h01**

Bit	Mode	Function
7-0	R/W	BLUE Initial Value [7:0]

Address: 26~27 Reserved

Display Format

Address: 28 VDIS_CTRL (Video Display Control Register) **Default: 20h**

Bit	Mode	Function
7	R/W	Force Display Timing Generator Enable: (Should be set when in Free-Run mode) 0: wait for input IVS trigger 1: force enable
6	R/W	Display Data Output Inverse Enable 0: Disable (Default) 1: Enable (only when data bus clamp to 0)
5	R/W	Display Output Force to Background Color 0: Display output operates normally 1: Display output is forced to the color as selected by background color (CR6D) (Default)
4	R/W	Display 18 bit RGB Mode Enable 0: All individual output pixels are full 24-bit RGB (Default) 1: All individual output pixels are truncated to 18-bit RGB (LSB 2 bits = 0)
3	R/W	Frame Sync Mode Enable 0: Free running mode (Default) 1: Frame sync mode

2	R/W	Display Output Double Port Enable 0: Single port output (Default) 1: Double port output
1	R/W	Display Output Run Enable 0: DHS, DVS, DEN & DATA bus are clamped to “0” (Default) 1: Display output normal operation.
0	R/W	Display Timing Run Enable 0: Display Timing Generator is halted, Zoom Filter halted (Default) 1: Display Timing Generator and Zoom Filter enabled to run normally

Steps to disable output: First set CR28[1]=0, set CR28[6], then set CR28[0]=0 to disable output.

Address: 29 **VDISP_SIGINV (Display Control Signal Inverted)** **Default: 00h**

Bit	Mode	Function
7	R/W	DHS Output Format Select (only available in Frame Sync) 0: The first DHS after DVS is active (Default) 1: The first DHS after DVS is inactive
6	R/W	Display Data Port Even/Odd Data Swap: 0: Disable (Default) 1: Enable
5	R/W	Display Data Port Red/Blue Data Swap 0: Disable (Default) 1: Enable
4	R/W	Display Data Port MSB/LSB Data Swap 0: Disable (Default) 1: Enable
3	R/W	Skew Display Data Output 0: Non-skew data output (Default) 1: Skew data output
2	R/W	Display Vertical Sync (DVS) Output Invert Enable: 0: Display Vertical Sync output normal active high logic (Default) 1: Display Vertical Sync output inverted logic
1	R/W	Display Horizontal Sync (DHS) Output Invert Enable: 0: Display Horizontal Sync output normal active high logic (Default) 1: Display Horizontal Sync output inverted logic
0	R/W	Display Data Enable (DEN) Output Invert Enable: 0: Display Data Enable output normal active high logic (Default) 1: Display Data Enable output inverted logic

Address: 2A DISP_ADDR (Display Format Address Port)

Bit	Mode	Function	
7	R/W	Display Setting Double buffer enable 0 : Disable 1 : Enable	
		Register	Trigger Event
		DH_TOTAL	DVS Rising
		ODD_FIXED_LAST EVEN_FIXED_LAST	DVS Rising
6	R/W	Display Double Buffer Ready 0: Not Ready to Apply 1: Ready to Apply When the list table of DISP_ADDR[7] is set, then enable DISP_ADDR[6], finally, hardware will auto load these value into RTD as the trigger event happens and clear DISP_ADDR[6] to 0.	
5:0	R/W	Display Format Address	

Address: 2B DISP_DATA (Display Format Data Port)

Bit	Mode	Function
7:0	R/W	Display Format Data

Address: 2B-00 DH_TOTAL_H (Display Horizontal Total Pixels)

Bit	Mode	Function
7:4	--	Reserved to 0
3:0	R/W	Display Horizontal Total Pixel Clocks: High Byte[11:8]

Address: 2B-01 DH_TOTAL_L (Display Horizontal Total Pixels)

Bit	Mode	Function
7:0	R/W	Display Horizontal Total Pixel Clocks: Low Byte[7:0]

Real DH_Total (Target value)= DH_Total (Register value)+ 4

Address: 2B-02 DH_HS_END (Display Horizontal Sync End)

Bit	Mode	Function
7:0	R/W	Display Horizontal Sync End[7:0]: Determines the width of DHS pulse in DCLK cycles

Address: 2B-03 DH_BKGD_STA_H (Display Horizontal Background Start)

Bit	Mode	Function
7:4	--	Reserved to 0
3:0	R/W	Display Horizontal Background Start: High Byte [11:8]

Address: 2B-04 DH_BKGD_STA_L (Display Horizontal Background Start)

Bit	Mode	Function
7:0	R/W	Display Horizontal Background Start: Low Byte [7:0]

Determines the number of DCLK cycles from leading edge of DHS to first pixel of Background region.

Real DH_BKGD_STA (Target value)= DH_BKGD_STA (Register value)+ 10

Address: 2B-05 DH_ACT_STA_H (Display Horizontal Active Start)

Bit	Mode	Function
7:4	--	Reserved to 0
3:0	R/W	Display Horizontal Active Region Start: High Byte [11:8]

Address: 2B-06 DH_ACT_STA_L (Display Horizontal Active Start)

Bit	Mode	Function
7:0	R/W	Display Horizontal Active Region Start: Low Byte [7:0]

Determines the number of DCLK cycles from leading edge of DHS to first pixel of Active region.

Real DH_ACT_STA (Target value)= DH_ACT_STA (Register value)+ 10

Address: 2B-07 DH_ACT_END_H (Display Horizontal Active End)

Bit	Mode	Function
7:4	--	Reserved to 0
3:0	R/W	Display Horizontal Active End: High Byte [11:8]

Address: 2B-08 DH_ACT_END_L (Display Horizontal Active End)

Bit	Mode	Function
7:0	R/W	Display Horizontal Active End: Low Byte [7:0]

Determines the number of DCLK cycles from leading edge of DHS to the pixel of background region.

Real DH_ACT_END (Target value)= DH_ACT_END (Register value)+ 10

Address: 2B-09 DH_BKGD_END_H (Display Horizontal Background End)

Bit	Mode	Function
7:4	--	Reserved to 0
3:0	R/W	Display Horizontal Background end: High Byte [11:8]

Address: 2B-0A DH_BKGD_END_L (Display Horizontal Background End)

Bit	Mode	Function
7:0	R/W	Display Horizontal Background end: Low Byte [7:0]

Real DH_BKGD_END (Target value) = DH_BKGD_END (Register value)+ 10

Address: 2B-0B DV_TOTAL_H (Display Vertical Total Lines)

Bit	Mode	Function
7:4	--	Reserved to 0
3:0	R/W	Display Vertical Total: High Byte [11:8]

Address: 2B-0C DV_TOTAL_L (Display Vertical Total Lines)

Bit	Mode	Function
7:0	R/W	Display Vertical Total: Low Byte [7:0]

CR2B-0B, CR2B-0C are used as watch dog reference value in *frame sync* mode, the event should be the line number of display HS is equal to DV Total.

Address: 2B-0D DVS_END (Display Vertical Sync End)

Bit	Mode	Function
7:5	--	Reserved to 0
4:0	R/W	Display Vertical Sync End[4:0]: Determines the duration of DVS pulse in lines

Address: 2B-0E DV_BKGD_STA_H (Display Vertical Background Start)

Bit	Mode	Function
7:4	--	Reserved to 0
3:0	R/W	Display Vertical Background Start: High Byte [11:8] Determines the number of lines from leading edge of DVS to first line of background region.

Address: 2B-0F DV_BKGD_STA_L (Display Vertical Background Start)

Bit	Mode	Function
7:0	R/W	Display Vertical Background Start: Low Byte [7:0]

Address: 2B-10 DV_ACT_STA_H (Display Vertical Active Start)

Bit	Mode	Function
7:4	--	Reserved to 0
3:0	R/W	Display Vertical Active Region Start: High Byte [11:8] Determines the number of lines from leading edge of DVS to first line of active region.

Address: 2B-11 DV_ACT_STA_L (Display Vertical Active Start)

Bit	Mode	Function
7:0	R/W	Display Vertical Active Region Start: Low Byte [7:0]

Address: 2B-12 DV_ACT_END_H (Display Vertical Active End)

Bit	Mode	Function
7:4	--	Reserved to 0
3:0	R/W	Display Vertical Active Region End: High Byte [11:8]

Address: 2B-13 DV_ACT_END_L (Display Vertical Active End)

Bit	Mode	Function
7:0	R/W	Display Vertical Active Region End: Low Byte [7:0]

Determine the number of lines from leading edge of DVS to the line of following background region.

Address: 2B-14 DV_BKGD_END_H (Display Vertical Background End)

Bit	Mode	Function
-----	------	----------

7:4	--	Reserved to 0
3:0	R/W	Display Vertical Background end: High Byte [11:8]

Address: 2B-15 DV_BKGD_END_L (Display Vertical Background End)

Bit	Mode	Function
7:0	R/W	Display Vertical Background End: Low Byte [7:0]

Determine the number of lines from leading edge of DVS to the line of start of vertical blanking.

Address: 2B-16~2B-1F Reserved

Display Fine Tune

Address: 2B-20 DIS_TIMING (Display Clock Fine Tuning Register)

Default: 00h

Bit	Mode	Function
7	R/W	Reserved to 0
6:4	R/W	Display Output Clock Fine Tuning Control: 000: DCLK rising edge corresponds with output display data 001: 1ns delay 010: 2ns delay 011: 3ns delay 100: 4ns delay 101: 5ns delay 110: 6ns delay 111: 7ns delay
3	---	Reserved
2	---	Reserved
1	R/W	DCLK Output Enable 0: Disable 1: Enable
0	R/W	DCLK Polarity Inverted 0: Disable 1: Enable

Address: 2B-21 OSD_REFERENCE_DEN

Default: 00h

Bit	Mode	Function
7:0	R/W	Position Of Reference DEN for OSD[7:0]

Address: 2B-22 NEW_DV_CTRL

Default: 00h

Bit	Mode	Function
7	R/W	New Timing Enable

		0: Disable 1: Enable
6	R/W	Line Compensation Enable 0: Disable 1: Enable
5	R/W	Pixel Compensation Enable 0: Disable 1: Enable
4	R/W	Reserve to 0
3:0	R/W	DCLK_Delay[11:8]

Address: 2B-23 NEW_DV_DLY **Default: 00h**

Bit	Mode	Function
7:0	R/W	DCLK_Delay[7:0]

When CR2B-22[7]=1, DCLK_Delay[11:0] can't be 0.

Address: 2B-24 SSCG_NEW_Timing_Mode Setting **Default: 00h**

Bit	Mode	Function
7	R/W	SSCG New Timing Mode Even/Odd last line setting iverse 0: no inverse 1: inverse
6	R/W	SSCG New Timing Mode Even/Odd last line setting enable 0: disable 1: enable
5:0	R/W	Reserve

Cyclic-Redundant-Check

Address: 2C OP_CRC_CTRL (Output CRC Control Register) **Default: 00h**

Bit	Mode	Function
7:6	R/W	CRC Selector 00: CRC after all processing others: reserved
5:1	--	Reserved to 0
0	R/W	Output CRC Control: 0: Stop or finish (Default) 1: Start

CRC function = $X^{24} + X^7 + X^2 + X + 1$.

Address: 2d OP_CRC_CHECKSUM (Output CRC Checksum)

Bit	Mode	Function
7:0	R/W	1 st read=> Output CRC-24 bit 23~16 2 nd read=> Output CRC-24 bit 15~8 3 rd read=> Out put CRC-24 bit 7~0

! The read pointer should be reset when 1. OP_CRC_BYTE is written 2. Output CRC Control starts.

! The read back CRC value address should be auto-increase, the sequence is shown above

Address 0x2E~0x2F are reserved.

FIFO Window

Address: 30 FIFO_WIN_ADDR (FIFO Window Address Port)

Bit	Mode	Function
7:5	--	Reserved to 0
4:0	R/W	FIFO Window Address Port

Address: 31 FIFO_WIN_DATA (FIFO Window Data Port)

Bit	Mode	Function
7:0	R/W	FIFO Window Data Port

! Port address will increase automatically after read/write.

Address: 31-00 DRL_H_BSU (Display Read High Byte Before Scaling-Up) Default: 00h

Bit	Mode	Function
7	--	Reserved
6:4	R/W	Display window read width before scaling up: High Byte [10:8]
3	--	Reserved
2:0	R/W	Display window read length before scaling up: High Byte [10:8]

Address: 31-01 DRW_L_BSU (Display Read Width Low Byte Before Scaling-Up) Default: 00h

Bit	Mode	Function
7:0	R/W	Display window read width before scaling up: Low Byte [7:0]

Address: 31-02 DRL_L_BSU (Display Read Length Low Byte Before Scaling-Up) Default: 00h

Bit	Mode	Function
7:0	R/W	Display window read length before scaling up: Low Byte [7:0]

! The setting above should be use 2 as unit

! The setting above should be use 2 as unit

Scaling Up Function

Address: 32 **SCALE_CTRL (Scale Control Register)** **Default: 00h**

Bit	Mode	Function
7	R/W	Video mode compensation: 0: Disable (Default) 1: Enable
6	R/W	Internal ODD-signal inverse for video-compensation 0: No invert (Default) 1: invert
5	R	Display Line Buffer Ready 0: Busy 1: Ready
4	R/W	Enable Full Line buffer: 0: Disable (Default) 1: Enable
3	R/W	Vertical Line Duplication 0: Disable 1: Enable
2	R/W	Horizontal pixel Duplication 0: Disable 1: Enable
1	R/W	Enable the Vertical Filter Function: 0: By pass the vertical filter function block (Default) 1: Enable the vertical filter function block
0	R/W	Enable the Horizontal Filter Function: 0: By pass the horizontal filter function block (Default) 1: Enable the horizontal filter function block

! When using H/V duplication mode, FIFO window width set original width, but FIFO window height should be 2X the original height.

Address: 33 **SF_ACCESS_Port** **Default: 00h**

Bit	Mode	Function
7	R/W	Enable scaling-factor access port
6:5	--	Reserved to 0
4:0	R/W	Scaling factor port address

! When disable scaling factor access port, the access port pointer will reset to 0

Address: 34-00 HOR_SCA_H (Horizontal Scale Factor High)

Bit	Mode	Function
7:4	--	Reserved
3:0	R/W	Bit [19:16] of horizontal scale factor

Address: 34-01 HOR_SCA_M (Horizontal Scale Factor Medium)

Bit	Mode	Function
7:0	R/W	Bit [15:8] of horizontal scale factor

Address: 34-02 HOR_SCA_L (Horizontal Scale Factor Low)

Bit	Mode	Function
7:0	R/W	Bit [7:0] of horizontal scale factor

Address: 34-03 VER_SCA_H (Vertical Scale Factor High)

Bit	Mode	Function
7:4	--	Reserved
3:0	R/W	Bit [19:16] of vertical scale factor

Address: 34-04 VER_SCA_M (Vertical Scale Factor Medium)

Bit	Mode	Function
7:0	R/W	Bit [15:8] of vertical scale factor

Address: 34-05 VER_SCA_L (Vertical Scale Factor Low)

Bit	Mode	Function
7:0	R/W	Bit [7:0] of vertical scale factor

This scale-up factor includes a 20-bit fraction part to present a vertical scaled up size over the stream input. For example, for 600-line original picture scaled up to 768-line, the factor should be as follows:

$$(600/768) \times 2^{20} = 0.78125 \times 2^{20} = 819200 = C8000h = 0Ch, 80h, 00h.$$

Address: 34-06 Horizontal Scale Factor Segment 1 Pixel Default: 00h

Bit	Mode	Function
7:3	--	Reserved
2:0	R/W	Bit [10:8] of Scaling Factor Segment 1 pixel

Address: 34-07 Horizontal Scale Factor Segment 1 Pixel Default: 00h

Bit	Mode	Function
7:0	R/W	Bit [7:0] of Scaling Factor Segment 1 pixel

Address: 34-08 Horizontal Scale Factor Segment 2 Pixel Default: 00h

Bit	Mode	Function
7:3	--	Reserved
2:0	R/W	Bit [10:8] of Scaling Factor Segment 2 pixel

Address: 34-09 Horizontal Scale Factor Segment 2 Pixel Default: 00h

Bit	Mode	Function
7:0	R/W	Bit [7:0] of Scaling Factor Segment 2 pixel
Address: 34-0A Horizontal Scale Factor Segment 3 Pixel Default: 00h		
Bit	Mode	Function
7:3	--	Reserved
2:0	R/W	Bit [10:8] of Scaling Factor Segment 3 pixel
Address: 34-0B Horizontal Scale Factor Segment 3 Pixel Default: 00h		
Bit	Mode	Function
7:0	R/W	Bit [7:0] of Scaling Factor Segment 3 pixel
Address: 34-0C Horizontal Scale Factor Delta 1 Default: 00h		
Bit	Mode	Function
7:5	--	Reserved
4:0	R/W	Bit [12:8] of Horizontal Scale Factor delta 1
Address: 34-0D Horizontal Scale Factor Delta 1 Default: 00h		
Bit	Mode	Function
7:0	R/W	Bit [7:0] of Horizontal Scale Factor delta 1
Address: 34-0E Horizontal Scale Factor Delta 2 Default: 00h		
Bit	Mode	Function
7:5	--	Reserved
4:0	R/W	Bit [12:8] of Horizontal Scale Factor delta 2
Address: 34-0F Horizontal Scale Factor Delta 2 Default: 00h		
Bit	Mode	Function
7:0	R/W	Bit [7:0] of Horizontal Scale Factor delta 2
Address: 34-10 Horizontal Filter Coefficient Initial Value Default: C4h		
Bit	Mode	Function
7:0	R/W	Accumulate Horizontal filter coefficient initial value
Address: 34-11 Vertical Filter Coefficient Initial Value Default: C4h		
Bit	Mode	Function
7:0	R/W	Accumulate Vertical filter coefficient initial value
Address: 35 FILTER_CTRL (Filter Control Register) Default: 00h		
Bit	Mode	Function
7	R/W	Enable Chroma Filter Coefficient Access 0: Disable (Default) 1: Enable
6	R/W	Select Chroma H/V User Defined Filter Coefficient Table for Access Channel

		0: 1 st coefficient table (Default) 1: 2 nd coefficient table
5	R/W	Select Chroma Horizontal user defined filter coefficient table 0: 1 st Horizontal Coefficient Table (Default) 1: 2 nd Horizontal Coefficient Table
4	R/W	Select Chroma Vertical user defined filter coefficient table 0: 1st Vertical Coefficient Table (Default) 1: 2 nd Vertical Coefficient Table
3	R/W	Enable Luminance Filter Coefficient Access 0: Disable (Default) 1: Enable
2	R/W	Select Luminance H/V User Defined Filter Coefficient Table for Access Channel 0: 1 st coefficient table (Default) 1: 2 nd coefficient table
1	R/W	Select Luminance Horizontal user defined filter coefficient table 0: 1 st Horizontal Coefficient Table (Default) 1: 2 nd Horizontal Coefficient Table
0	R/W	Select Luminance Vertical user defined filter coefficient table 0: 1st Vertical Coefficient Table (Default) 1: 2 nd Vertical Coefficient Table

- l The User Defined Filter Coefficient Table can be modified on-line. Only the non-active coefficient-table can be modified, and then switch it to active.
- l When CR35[7] and CR35[3] are zero, the write counter of FILTER_PORT is reset to zero. You should reset counter before another setting.
- l If both CR35[7] and CR35[3] are one, you can set chroma and luminance coefficient at the same time.

Address: 36 **FILTER_PORT (User Defined Filter Access Port)** **Default: 00h**

Bit	Mode	Function
7:0	W	Access port for user defined filter coefficient table

- l When enable filter coefficient accessing, the first write byte is stored into the LSB(bit[7:0]) of coefficient #1 and the second byte is into MSB (bit[8:11]). Therefore, the valid write sequence for this table is c0-LSB, c0-MSB, c1-LSB, c1-MSB, c2-LSB, c2-MSB ... c63-LSB & c63-MSB, totally 64 * 2 cycles. Since the 128 taps is symmetric, we need to fill the 64-coefficient sequence into table only.

Address: 37~3F Reserved

Frame Sync Fine Tune

Address: 40 **IVS2DVS_DEALY_LINES (IVS to DVS Lines)** **Default: 00h**

Bit	Mode	Function
7:0	R/W	IVS to DVS Lines: (Only for FrameSync Mode) The number of input HS from IVS to DVS. Should be double buffer by CR10[5:4]

Address: 41 **IV_DV_DELAY_CLK_ODD (Frame Sync Delay Fine Tuning)** **Default: 00h**

Bit	Mode	Function
7:0	R/W	Frame Sync Mode Delay Fine Tune [7:0] Applied to all fields when Interlaced_FS_Delay_Fine_Tuning is disabled (CR43[1] = 0) Only for odd-field when Interlaced_FS_Delay_Fine_Tuning is enabled (CR43[1] = 1)

In Frame Sync Mode , CR41[7:0] represents output VS delay fine-tuning. It delays the number of (CR41 [7:0] *16 + 16) input clocks if CR41[7:0] is not equal to 0. (No delay fine-tune if CR41[7:0] = 0)

Address: 42 **IV_DV_DELAY_CLK_EVEN (Frame Sync Delay Fine Tuning)** **Default: 00h**

Bit	Mode	Function
7:0	R/W	Frame Sync Mode Delay Fine Tune [7:0] “00” to disable Only for even-field when Interlaced_FS_Delay_Fine_Tuning is enabled (CR43[1] = 1)

Address: 43 **FS_DELAY_FINE_TUNING** **Default: 00h**

Bit	Mode	Function
7	R/W	Enable measure last line by field 0 : disable 1: enable
6	R/W	Reference field in last line measure 0 : Odd 1 : Even
5:2	R/W	Reserved to 0
1	R/W	Interlaced_FS_Delay_Fine_Tuning 0: Disable (Default) 1: Enable
0	R/W	Internal ODD-signal inverse for Interlaced_FS_Delay_Fine_Tuning 0: No invert (Default) 1: Invert

Address: 44 **LAST_LINE_H** **Default: 00h**

Bit	Mode	Function
7	R/W	Last-line-width / DV-Total Selector :

		0: CR44 [3:0] and CR45 indicate last-line width counted by display clock (Default) 1: CR44 [3:0] and CR45 indicate DHS total number between 2 DVS.
6	R/W	DV sync with 4X clock 0: Disable 1: Enable
5	R/W	BIST Test Enable 0: Disable 1: Enable (Auto clear when finish)
4	R/W	BIST Test Result 0: Fail 1: Ok
3:0	R	DV Total or Last Line Width[11:8] Before Sync in Frame Sync Mode

Address: 45 LAST_LINE_L

Bit	Mode	Function
7:0	R	DV Total or Last Line Width[7:0] Before Sync in Frame Sync Mode

Address: 46 Reserved as page selector for new sync-processor feature

Sync Processor

Address: 47 SYNC_SELECT **Default: 00h**

Bit	Mode	Function
7	R/W	On line Sync Processor Power Down (Stop Crystal Clock In) 0: Normal Run (Default) 1: Power Down
6	R/W	HSYNC Type Detection Auto Run 0: manual (Default) 1: automatic
5	R/W	De-composite circuit enable 0: Disable (Default) 1: Enable
4	R/W	Input Sync. Source selection 0: HS_RAW(SS/CS) (Default) 1: SOG/SOY
3	R/W	SOG Source Selection 0: SOG0/SOY0 (Default) 1: SOG1/SOY1
2	R/W	VGA-ADC HS/VS Source

		0: 1 ST HS/VS (Default) 1: 2 ND HS/VS
1	R/W	Measured by Crystal Clock (Result shown in CR59) (in Digital Mode) 0: Input Active Region (Vertical IDEN start to IDEN stop) (measure at IDEN STOP) (Default) 1: Display Active Region (Vertical DEN start to DEN stop) (measure at DEN STOP) The function should work correctly when IVS or DVS occurs and enable by CR50[4].
0	R/W	HSYNC & VSYNC Measured Mode 0: HS period counted by crystal clock & VS period counted by HS (Analog mode) (Default) 1: H resolution counted by input clock & V resolution counted by ENA (Digital mode) (Get the correct resolution which is triggered by enable signal, ENA)

Address: 48
SYNC_INVERT
Default: 00h

Bit	Mode	Function
7	R/W	COAST Signal Invert Enable: 0: Not inverted (Default) 1: Inverted
6	R/W	COAST Signal Output Enable: 0: Disable (Default) 1: Enable
5	R/W	HS_OUT Signal Invert Enable: 0: Not inverted (Default) 1: Inverted
4	R/W	HS_OUT Signal Output Enable: 0: Disable (Default) 1: Enable
3	R/W	CS_RAW Inverted Enable 0: Normal (Default) 1: Invert
2	R/W	CLAMP Signal Output Enable 0: Disable (Default) 1: Enable
1	R/W	HS Recovery in Coast 0: Disable (Default) (SS/SOY) 1: Enable (CS or SOG)
0	R/W	HSYNC Synchronize source 0: AHS (Default) 1: Feedback HS

Address: 49 **SYNC_CTRL (SYNC Control Register)** **Default: 06h**

Bit	Mode	Function
7	R/W	CLK Inversion to latch Feedback HS for Coast Recovery (Coast Recovery means HS feedback to replace input HS) 0: Non Inversion (Default) 1: Inversion
6	R/W	Select HS_OUT Source Signal 0: Bypass (SeHs)(Use in Separate Mode) 1: Select De-Composite HS out(DeHs) (In Composite mode)
5	R/W	Select ADC_VS Source Signal (Auto switch in Auto Run Mode) 0: VS_RAW 1: DeVS
4	R/W	CLK Inversion to latch ADC HS for Clamp 0: Non Inversion (Default) 1: Inversion
3	R/W	Inversion of HSYNC to measure VSYNC 0: Non Inversion (Default) 1: Inversion
2	R/W	HSYNC Measure Source(ADC_HS1) 0: Select ADC_HS 1: Select SeHS or DeHS by CR49[6] (Default)
1:0	R/W	Measure HSYNC/VSYNC Source Select: 00: Reserved 01: VIDEO8 / VIDEO16 10: ADC_HS1/ADC_VS (Default) 11: CS_RAW/VS_RAW

Address: 4A **STABLE_HIGH_PERIOD_H** **Default: 00h**

Bit	Mode	Function
7	R	Even/Odd Field of YPbPr (By Line-Count Mode) 0: Even 1: Odd
6	R	The Toggling of Polarity of YPbPr Field Happened (By Line-Count Mode) 0: No toggle 1: Toggle
5	R	Even/Odd Field of YPbPr (By VS-Position Mode) 0: Even

		1: Odd
4	R	The Toggling of Polarity of YPbPr Field Happened (By VS-Position Mode) 0: No toggle 1: Toggle
3	R/W	Odd Detection Mode 0: Line-Count Mode (Default) 1: VS-Position Mode
2:0	R	Stable High Period[10:8] Compare each line's high pulse period, if we get continuous 64 lines with the same one, the period is updated as the stable period.

Address: 4B **STABLE_HIGH_PERIOD_L**

Bit	Mode	Function
7:0	R	Stable High Period[7:0] Compare each line's high pulse period, if we get continuous 64 lines with the same one, the period is updated as the stable period.

Address: 4C **VSYNC_COUNTER_LEVEL_MSB** **Default: 03h**

Bit	Mode	Function
7	R	HSYNC Type Detection Auto Run Result ready
6:4	R	HSYNC Type Detection Auto Run Result 000: No Signal 001: Not Support 010: YPbPr 011: Serration Composite SYNC 100: XOR/OR-Type Composite SYNC with Equalizer 101: XOR/OR-Type Composite SYNC without Equalizer 110: HSYNC with VS_RAW (Separate HSYNC) 111: HSYNC without VS_RAW (HSYNC only) Reference when Hsync type detection auto run result ready (CR4C[7])
3	R/W	Reserved to 0
2:0	R/W	VSYNC counter level count [10:8] MSB VSYNC detection counter start value.

Address: 4D **VSYNC_COUNTER_LEVEL_LSB** **Default: 00h**

Bit	Mode	Function
7:0	R/W	VSYNC counter level count [7:0] LSB

Address: 4E **HSYNC_TYPE_DETECTION_FLAG**

Bit	Mode	Function
7	R	HSYNC Overflow (16-bits)

6	R	Stable Period Change (write clear when CR4E[6]=1 or CR4F[0]=1)
5	R	Stable Polarity Change (write clear when CR4E[5]=1 or CR4F[0]=1)
4	R	VS_RAW Edge Occurs (write clear when CR4E[4]=1 or CR4F[0]=1) If VS_RAW edge occurs, this bit is set to “1”.
3	R	Detect Capture Window Unlock Repeated 32 Times (write clear when CR4E[3]=1 or CR4F[0]=1)
2	R	HSYNC with Equalization (write clear when CR4E[2]=1 or CR4F[0]=1)
1	R	HSYNC Polarity Change (write clear when CR4E[1]=1 or CR4F[0]=1)
0	R	Detect Capture Window Unlock (write clear when CR4E[0]=1 or CR4F[0]=1)

Address: 4F
STABLE_MEASURE
Default: 00h

Bit	Mode	Function
7	R	Stable Flag 0: Period or polarity can't get continuous stable status. 1: Both polarity and period are stable.
6	R	Stable Polarity 0: Negative 1: Positive Compare each line's polarity; if we get continuous N 64 lines with the same one, the polarity is updated as the stable polarity.
5:4	R/W	Feedback HSYNC High Period Select by ADC Clock: 00: 32 (Default) 01: 64 10: 96 11: 128
3	R/W	Stable Period Tolerance 0: ±2 crystal clks (Default) 1: ±4 crystal clks
2	R/W	VSYNC measure invert Enable 0: Disable (Default) 1: Enable
1	R/W	Pop Up Stable Value 0: No Pop Up (Default) 1: Pop Up Result, (CR4A[2:0], CR4B[7:0], CR4E[3], CR50[2:0], CR51[7:0])
0	R/W	Stable Measure Start 0: Stop (Default) 1: Start

Address: 50 Stable_Period_H Default: 00h

Bit	Mode	Function
7	R	Measure One Frame Status 0: Finished after 1 frame measuring / Measure finished 1: Measuring Now
6	R	CS_RAW Inverted by Auto Run Mode 0: Not inverted 1: Inverted
5	R/W	HS_OUT Bypass PLL into VGIP 0: Disable (Default) 1: Enable
4	R/W	Active Region Measure Enable 0: Disable (Default) 1: Enable
3	R/W	ADC_VS Source Select in Test Mode 0: Select ADC_VS Source in Normal Mode or Auto Mode by CR47[6] (Default) 1: Select ADC_VS Source in Test Mode (Select VS_RAW or DeVS by CR49[5])
2:0	R	Stable Period[10:8] Compare each line's period, if we get continuous 64 lines with the same one, the period is updated as the stable period.

Address: 51 Stable_Period_L

Bit	Mode	Function
7:0	R	Stable Period[7:0] Compare each line's period, if we get continuous 64 lines with the same one, the period is updated as the stable period.

Address: 52 MEAS_HS_PER_H (HSYNC Period Measured Result) Default: 8'b000xxxxx

Bit	Mode	Function
7	R/W	Auto Measure Enable 0: Disable (Default) 1: Enable
6	R/W	Pop Up Period Measurement Result 0: No Pop Up (Default) 1: Pop Up Result
5	R/W	Start a HS & VS period / H & V resolution & polarity measurement (on line monitor) 0: Finished/Disable (Default) 1: Enable to start a measurement, auto cleared after finished

4	R	Over-flow bit of Input HSYNC Period Measurement 0: No Over-flow occurred 1: Over-flow occurred
3:0	R	Input HSYNC Period Measurement Result: High Byte[11:8]

Address: 53 MEAS_HS_PER_L (HSYNC Period Measured Result)

Bit	Mode	Function
7:0	R	Input HSYNC Period Measurement Result: Low Byte[7:0]

I The result is expressed as the average number of crystal clocks (CR47[0]=0), or input clocks (CR47[0]=1) between 2 HSYNC.

I The result is the total number of crystal/input clocks inside 16-HSYNC periods divided by 16.

I Fractional part of measure result is stored in CR56[3:0].

Address: 54 MEAS_VS_PER_H (VSYNC Period Measured Result)

Bit	Mode	Function
7	R	Input VSYNC Polarity Indicator 0: negative polarity (high period is longer than low one) 1: positive polarity (low period is longer than high one)
6	R	Input HSYNC Polarity Indicator 0: negative polarity (high period is longer than low one) 1: positive polarity (low period is longer than high one)
5	R	Time-Out bit of Input VSYNC Period Measurement (No VSYNC occurred) 0: No Time Out 1: Time Out occurred
4	R	Over-flow bit of Input VSYNC Period Measurement 0: No Over-flow occurred 1: Over-flow occurred
3:0	R	Input VSYNC Period Measurement Result: High Byte[11:8]

Address: 55 MEAS_VS_PER_L (VSYNC Period Measured Result)

Bit	Mode	Function
7:0	R	Input VSYNC Period Measurement Result: Low Byte[7:0]

I This result is expressed in terms of input HS pulses.

I When measured digitally, the result is expressed as the number of input ENA signal within a frame.

Address: 56 MEAS_HS&VS_HI_H (HSYNC&VSYNC High Period Measured Result)

Bit	Mode	Function
7:4	R	Input HSYNC High Period Measurement Result: High Byte[11:8] (CR58[0] = 0) Input VSYNC High Period Measurement Result: High Byte[11:8] (CR58[0] = 1)
3:0	R	Input HSYNC Period Measurement Fractional Result (See CR52,53)

Address: 57 MEAS_HS&VS_HI_L (HSYNC&VSYNC High Period Measured Result)

Bit	Mode	Function
7:0	R	Input HSYNC High Period Measurement Result: Low Byte[7:0] (CR58[0] = 0) Input VSYNC High Period Measurement Result: Low Byte[7:0] (CR58[0] = 1)

| This result of HSYNC high-period is expressed in terms of crystal clocks. When measured digitally, the result of HSYNC high-period is expressed as the number of input clocks inside the input enable signal.

| This result of VSYNC high-period is expressed in terms of input HS pulses

Address: 58 MEAS_HS&VS_HI_SEL (VSYNC High Period Measured select) Default: 02h

Bit	Mode	Function
7:6	R/W	HSYNC_MAX_DELTA 00: Don't care (CR58[3] will never go high) 01: 4-clock 10: 8-clock 11: 16-clock
5:4	R/W	VSYNC_MAX_DELTA 00: Don't care (CR58[2] will never go high) 01: 2-HSYNC 10: 4-HSYNC 11: 8-HSYNC
3	R	HSYNC_OVER_RANGE Set to 1 if variation of HSYNC larger than HSYNC_MAX_DELTA is detected by on-line measurement (CR52[7]=1). Write to clear this flag.
2	R	VSYNC_OVER_RANGE Set to 1 if variation of VSYNC larger than VSYNC_MAX_DELTA is detected by on-line measurement (CR52[7]=1). Write to clear this flag.
1	R/W	Start Measurement after Mode Detection Auto-mode 0: Disable 1: Enable (Default)
0	R/W	HSYNC/VSYNC High Period Measurement Result Select 0: HSYNC 1: VSYNC (See CR56~CR57)

Address: 59 MEAS_ACTIVE_REGION_H (Active Region Measured by CRSTL_CLK Result)

Bit	Mode	Function
7:0	R/W	Active Region Measured By Crystal Clock 1st read: Measurement Result: High Byte[23:16]

		2nd read: Measurement Result: High Byte[15:8] 3rd read: Measurement Result: High Byte[8:0] Read pointer is auto increase, if write, the pointer is also reset to 1 st result.
--	--	--

Address: 5A **SYNC_TEST_MISC** **Default: 00h**

Bit	Mode	Function
7	R/W	Clamp Reference Source Selection 0: Clamp source from normal HS 1: Clamp source from CS_RAW
6	R/W	Sync Processor Time-Clock Test Mode 0: Normal (Default) 1: Enable Test Mode; (switch 70ns-ck to the time-out & polarity counters)
5:3	R/W	Sync Processor Test Signals Output Selection (only active when on-line test-mode disable) 000: Disable Test-Output (Default) 001~111: Hidden
2:0	R	The Number of Input HS between 2 Input VSYNC. LSB bit [2:0] for YPbPr

Address: 5B Reserved

Address: 5C **SYNC_PROC_PORT_ADDR** **Default: 00h**

Bit	Mode	Function
7:5	R/W	Reserved
4:0	R/W	Sync Processor Access Port Address

Address: 5D **SYNC_PROC_PORT_DATA** **Default: 00h**

Bit	Mode	Function
7:0	R/W	Sync Processor Access Port Data

! Port address will increase automatically after read/write.

Address: 5D-00 **G_CLAMP_START (Clamp Signal Output Start)** **Default: 04h**

Bit	Mode	Function
7:0	R/W	Start of Output Clamp Signal Pulse for Y/G Channel[7:0]: Determine the number of input double-pixel between the trailing edge of input HSYNC and the start of the output CLAMP signal.

Address: 5D-01 **G_CLAMP_END (Clamp Signal Output End)** **Default: 10h**

Bit	Mode	Function
7:0	R/W	End of Output Clamp Signal Pulse for Y/G Channel [7:0]: Determine the number of input double-pixel between the trailing edge of input HSYNC and the end of the output CLAMP signal.

Address: 5D-02 **BR_CLAMP_START (Clamp Signal Output Start)** **Default: 04h**

Bit	Mode	Function
7:0	R/W	Start of Output Clamp Signal Pulse for B/Pb and R/Pr Channel [7:0]: Determine the number of input double-pixel between the trailing edge of input HSYNC and the start of the output CLAMP signal.

Address: 5D-03 BR_CLAMP_END (Clamp Signal Output End) Default: 10h

Bit	Mode	Function
7:0	R/W	End of Output Clamp Signal Pulse for B/Pb and R/Pr Channel [7:0]: Determine the number of input double-pixel between the trailing edge of input HSYNC and the end of the output CLAMP signal.

Address: 5D-04 CLAMP_CTRL0 Default:00h

Bit	Mode	Function
7	R/W	Clamp Trigger Edge Inverse for Y/G Channel 0: Trailing edge (Default) 1: Leading edge
6	R/W	Clamp Trigger Edge Inverse for B/Pb and R/Pr Channel 0: Trailing edge (Default) 1: Leading edge
5:0	R/W	Mask Line Number before DeVS [5:0]

Address: 5D-05 CLAMP_CTRL1 Default: 00h

Bit	Mode	Function
7	R/W	Clamp Mask Enable 0: Disable (Default) 1: Enable
6	R/W	Select Clamp Mask as De VS 0: Disable 1: Enable
5:0	R/W	Mask Line Number after DeVS [5:0]

CR5D-04[5:0] and CR5D-05[5:0] will set number of Mask Line before/after DeVS for Clamp Mask.

Address: 5D-06 CLAMP_CTRL2 Default: 00h

Bit	Mode	Function
7	R/W	Clamp Clock Source 0: ADC_Clock (Default) 1: Crystal Clock
6	R/W	Clamp Counter Unit (0x5D-00 – 0x5D-03) 0: Double Pixels (Default) 1: Single Pixel

5	R/W	Off-line ADC Clamp Enable 0: Disable (Default) 1: Enable
4	R/W	Off-line ADC Selection 0: ADC-0 (Default) 1: ADC-1
3	R/W	On-Line ADC-3 Clamp Source 0: Clamp-G (Default) 1: Clamp-BR
3	R/W	On-Line ADC-2 Clamp Source 0: Clamp-G (Default) 1: Clamp-BR
3	R/W	On-Line ADC-1 Clamp Source 0: Clamp-G (Default) 1: Clamp-BR
3	R/W	On-Line ADC-0 Clamp Source 0: Clamp-G (Default) 1: Clamp-BR

Address: 5D-07 COAST_CTRL **Default: 21h**

Bit	Mode	Function
7:4	R/W	Start of COAST before DeVS Leading Edge [3:0]
3:0	R/W	End of COAST after DeVS Trailing Edge [3:0]

Address: 5D-08 CAPTURE_WINDOW_SETTING **Default: 04h**

Bit	Mode	Function
7	R/W	Reserved to 0
6	R/W	Capture Miss Limit during Hsync Extraction 0: 32 (Default) 1: 16
5	R/W	Capture Window add step as Miss Lock 0: ± 1 crystal clks (Default) 1: ± 2 crystal clks
4:0	R/W	Capture Window Tolerance 5'h00: ± 6 crystal clks for capture window 5'h01 ~ 5'b1F: $\pm 1 \sim \pm 31$ crystal clks for capture window

Address: 5D-09 DETECTION_TOLERANCE_SETTING **Default: 00h**

Bit	Mode	Function
7	R/W	Reserved to 0

6:5	R/W	Stable Period Tolerance Extension 00: Use 0x4F[3] Setting (Default) 01: ± 4 crystal clks 10: ± 8 crystal clks 11: ± 16 crystal clks
4:0	R/W	H-sync for De-composite De-bounce Length 5'h00: Disable De-bounce Function (Default) 5'h01 ~ 5'h1F: De-bounce 1 ~ 31 crystal clks for de-composite

Address: 5D-08~0F Reserved

Macro Vision

Address: 5D-10 MacroVision Control

Default: 00h

Bit	Mode	Function
7:4	R/W	Skip Line[3:0] Skip Lines after Vsync detected
3:2	R/W	Reserved to 0
1	R	MacroVision Detected (On-line monitor) When detected Macrovision occurred, this bit set to 1, else clear to 0.
0	R/W	MacroVision Enable 0: Disable (Default) 1: Enable

Address: 5D-11 MacroVision Start Line in Even Field

Bit	Mode	Function
7	R/W	Reserved to 0
6:0	R	MacroVision Start Line in Even Field [6:0]

Address: 5D-12 MacroVision End Line in Even Field

Bit	Mode	Function
7	R	Indicate the validity of Macro Vision Line in Even Field 0: not valid 1: valid
6:0	R	MacroVision End Line 0 [6:0]

Address: 5D-13 MacroVision Start Line in Odd Field

Bit	Mode	Function
7	R/W	Reserved to 0
6:0	R	MacroVision Start Line in Odd Field [6:0]

Address: 5D-14 MacroVision End Line in Odd Field

Bit	Mode	Function
7	R	Indicate the validity of Macro Vision Line in Odd Field 0: not valid 1: valid
6:0	R	MacroVision End Line in Odd Field [6:0]

Address: 5D-15 Macro Vision Detect De-bounce **Default: 00h**

Bit	Mode	Function
7:5	R/W	Reserved to 0
4:0	R/W	H-sync for Macro-Vision Detection De-bounce Length 5'h00 ~ 5'h07: De-bounce 7 crystal clks for de-composite (Default) 5'h08 ~ 5'h1F: De-bounce 8 ~ 31 crystal clks for de-composite

Address 0x5E is reserved

Highlight window

Address: 60 Highlight Window Access Port control **Default: 00h**

Bit	Mode	Function
7	R/W	Enable highlight window access port
6	R/W	Enable highlight window
5:4	--	Reserved
3:0	R/W	Highlight-window port address

Address: 61-00 Highlight Window Horizontal Start

Bit	Mode	Function
7:0	--	Reserved
2:0	R/W	Highlight window horizontal start[10:8]

Address: 61-01 Highlight Window Horizontal Start

Bit	Mode	Function
7:0	R/W	Highlight window horizontal start[7:0]

Address: 61-02 Highlight Window Horizontal End

Bit	Mode	Function
7:3	--	Reserved
2:0	R/W	Highlight window horizontal end[10:8]

Address: 61-03 Highlight Window Horizontal End

Bit	Mode	Function
7:0	R/W	Highlight window horizontal end[7:0]

Address: 61-04 Highlight Window Vertical Start

Bit	Mode	Function
7:3	--	Reserved
2:0	R/W	Highlight window vertical start[10:8]

Address: 61-05 Highlight Window Vertical Start

Bit	Mode	Function
7:0	R/W	Highlight window vertical start[7:0]

Address: 61-06 Highlight Window Vertical End

Bit	Mode	Function
7:3	--	Reserved
2:0	R/W	Highlight window vertical end[10:8]

Address: 61-07 Highlight Window Vertical End

Bit	Mode	Function
7:0	R/W	Highlight window vertical end[7:0]

Highlight window horizontal/vertical reference point is DEN (display background start).

Address: 61-08 Highlight Window Border

Bit	Mode	Function
7:4	--	Reserved
3:0	R/W	Highlight window border width

Address: 61-09 Highlight Window Border Color

Bit	Mode	Function
7:6	--	Reserved
5:0	R/W	Highlight window border red color MSB 6bit (red color 2-bit LSB = 00)

Address: 61-0A Highlight Window Border Color

Bit	Mode	Function
7:6	--	Reserved
5:0	R/W	Highlight window border green color MSB 6bit (green color 2-bit LSB = 00)

Address: 61-0B Highlight Window Border Color

Bit	Mode	Function
7:6	--	Reserved
5:0	R/W	Highlight window border blue color MSB 6bit (blue color 2-bit LSB = 00)

Address: 61-0C Highlight Window Control 0
Default : 00h

Bit	Mode	Function
7:6	R/W	Contrast / brightness application control 00: Set A used on full region

		<p>01: Set B used inside highlight window</p> <p>10: Set A used outside highlight window</p> <p>11: Set A used outside highlight window, and Set B used inside highlight window</p> <table border="1"> <thead> <tr> <th>Contrast (CR62[1])</th> <th>Application control</th> <th>Inside window</th> <th>Outside window</th> </tr> </thead> <tbody> <tr> <td>0</td> <td>X</td> <td>bypass</td> <td>bypass</td> </tr> <tr> <td>1</td> <td>CR61-0C[7:6]=00 CR60[6]=0</td> <td>Set A</td> <td>Set A</td> </tr> <tr> <td>1</td> <td>CR61-0C[7:6]=01 && CR60[6]=1</td> <td>Set B</td> <td>bypass</td> </tr> <tr> <td>1</td> <td>CR61-0C[7:6]=10 && CR60[6]=1</td> <td>bypass</td> <td>Set A</td> </tr> <tr> <td>1</td> <td>CR61-0C[7:6]=11 && CR60[6]=1</td> <td>Set B</td> <td>Set A</td> </tr> </tbody> </table> <table border="1"> <thead> <tr> <th>Brightness (CR62[0])</th> <th>Application control</th> <th>Inside window</th> <th>Outside window</th> </tr> </thead> <tbody> <tr> <td>0</td> <td>X</td> <td>bypass</td> <td>bypass</td> </tr> <tr> <td>1</td> <td>CR61-0C[7:6]=00 CR60[6]=0</td> <td>Set A</td> <td>Set A</td> </tr> <tr> <td>1</td> <td>CR61-0C[7:6]=01 && CR60[6]=1</td> <td>Set B</td> <td>bypass</td> </tr> <tr> <td>1</td> <td>CR61-0C[7:6]=10 && CR60[6]=1</td> <td>bypass</td> <td>Set A</td> </tr> <tr> <td>1</td> <td>CR61-0C[7:6]=11 && CR60[6]=1</td> <td>Set B</td> <td>Set A</td> </tr> </tbody> </table>	Contrast (CR62[1])	Application control	Inside window	Outside window	0	X	bypass	bypass	1	CR61-0C[7:6]=00 CR60[6]=0	Set A	Set A	1	CR61-0C[7:6]=01 && CR60[6]=1	Set B	bypass	1	CR61-0C[7:6]=10 && CR60[6]=1	bypass	Set A	1	CR61-0C[7:6]=11 && CR60[6]=1	Set B	Set A	Brightness (CR62[0])	Application control	Inside window	Outside window	0	X	bypass	bypass	1	CR61-0C[7:6]=00 CR60[6]=0	Set A	Set A	1	CR61-0C[7:6]=01 && CR60[6]=1	Set B	bypass	1	CR61-0C[7:6]=10 && CR60[6]=1	bypass	Set A	1	CR61-0C[7:6]=11 && CR60[6]=1	Set B	Set A
Contrast (CR62[1])	Application control	Inside window	Outside window																																															
0	X	bypass	bypass																																															
1	CR61-0C[7:6]=00 CR60[6]=0	Set A	Set A																																															
1	CR61-0C[7:6]=01 && CR60[6]=1	Set B	bypass																																															
1	CR61-0C[7:6]=10 && CR60[6]=1	bypass	Set A																																															
1	CR61-0C[7:6]=11 && CR60[6]=1	Set B	Set A																																															
Brightness (CR62[0])	Application control	Inside window	Outside window																																															
0	X	bypass	bypass																																															
1	CR61-0C[7:6]=00 CR60[6]=0	Set A	Set A																																															
1	CR61-0C[7:6]=01 && CR60[6]=1	Set B	bypass																																															
1	CR61-0C[7:6]=10 && CR60[6]=1	bypass	Set A																																															
1	CR61-0C[7:6]=11 && CR60[6]=1	Set B	Set A																																															
5:4	R/W	<p>Gamma application control</p> <p>00: gamma used on full region</p> <p>01: gamma used inside window</p> <p>10: gamma used outside window</p> <p>11: reserved</p> <table border="1"> <thead> <tr> <th>Gamma (CR67[6])</th> <th>Application control</th> <th>Inside window</th> <th>Outside window</th> </tr> </thead> <tbody> <tr> <td>0</td> <td>X</td> <td>bypass</td> <td>bypass</td> </tr> <tr> <td>1</td> <td>CR61-0C[5:4]=00 CR60[6]=0</td> <td>Gamma</td> <td>Gamma</td> </tr> <tr> <td>1</td> <td>CR61-0C[5:4]=01 && CR60[6]=1</td> <td>Gamma</td> <td>bypass</td> </tr> <tr> <td>1</td> <td>CR61-0C[5:4]=10 && CR60[6]=1</td> <td>bypass</td> <td>Gamma</td> </tr> </tbody> </table>	Gamma (CR67[6])	Application control	Inside window	Outside window	0	X	bypass	bypass	1	CR61-0C[5:4]=00 CR60[6]=0	Gamma	Gamma	1	CR61-0C[5:4]=01 && CR60[6]=1	Gamma	bypass	1	CR61-0C[5:4]=10 && CR60[6]=1	bypass	Gamma																												
Gamma (CR67[6])	Application control	Inside window	Outside window																																															
0	X	bypass	bypass																																															
1	CR61-0C[5:4]=00 CR60[6]=0	Gamma	Gamma																																															
1	CR61-0C[5:4]=01 && CR60[6]=1	Gamma	bypass																																															
1	CR61-0C[5:4]=10 && CR60[6]=1	bypass	Gamma																																															
3:2	R/W	DCC/ICM application control																																																

		00: DCC/ICM used on full region 01: DCC/ICM used inside window 10: DCC/ICM used outside window 11: Reserved																																								
		<table border="1"> <thead> <tr> <th>ICM (CRE0[7])</th> <th>Application control</th> <th>Inside window</th> <th>Outside window</th> </tr> </thead> <tbody> <tr> <td>0</td> <td>X</td> <td>bypass</td> <td>bypass</td> </tr> <tr> <td>1</td> <td>CR61-0C[3:2]=00 CR60[6]=0</td> <td>ICM</td> <td>ICM</td> </tr> <tr> <td>1</td> <td>CR61-0C[3:2]=01 && CR60[6]=1</td> <td>ICM</td> <td>bypass</td> </tr> <tr> <td>1</td> <td>CR61-0C[3:2]=10 && CR60[6]=1</td> <td>bypass</td> <td>ICM</td> </tr> </tbody> </table> <table border="1"> <thead> <tr> <th>DCC (CRE4[7])</th> <th>Application control</th> <th>Inside window</th> <th>Outside window</th> </tr> </thead> <tbody> <tr> <td>0</td> <td>X</td> <td>bypass</td> <td>bypass</td> </tr> <tr> <td>1</td> <td>CR61-0C[3:2]=00 CR60[6]=0</td> <td>DCC</td> <td>DCC</td> </tr> <tr> <td>1</td> <td>CR61-0C[3:2]=01 && CR60[6]=1</td> <td>DCC</td> <td>bypass</td> </tr> <tr> <td>1</td> <td>CR61-0C[3:2]=10 && CR60[6]=1</td> <td>bypass</td> <td>DCC</td> </tr> </tbody> </table>	ICM (CRE0[7])	Application control	Inside window	Outside window	0	X	bypass	bypass	1	CR61-0C[3:2]=00 CR60[6]=0	ICM	ICM	1	CR61-0C[3:2]=01 && CR60[6]=1	ICM	bypass	1	CR61-0C[3:2]=10 && CR60[6]=1	bypass	ICM	DCC (CRE4[7])	Application control	Inside window	Outside window	0	X	bypass	bypass	1	CR61-0C[3:2]=00 CR60[6]=0	DCC	DCC	1	CR61-0C[3:2]=01 && CR60[6]=1	DCC	bypass	1	CR61-0C[3:2]=10 && CR60[6]=1	bypass	DCC
ICM (CRE0[7])	Application control	Inside window	Outside window																																							
0	X	bypass	bypass																																							
1	CR61-0C[3:2]=00 CR60[6]=0	ICM	ICM																																							
1	CR61-0C[3:2]=01 && CR60[6]=1	ICM	bypass																																							
1	CR61-0C[3:2]=10 && CR60[6]=1	bypass	ICM																																							
DCC (CRE4[7])	Application control	Inside window	Outside window																																							
0	X	bypass	bypass																																							
1	CR61-0C[3:2]=00 CR60[6]=0	DCC	DCC																																							
1	CR61-0C[3:2]=01 && CR60[6]=1	DCC	bypass																																							
1	CR61-0C[3:2]=10 && CR60[6]=1	bypass	DCC																																							
1:0	R/W	/DLTI/DCTI/Peaking/Coring application control 00: Full region 01: Inside window 10: Outside window 11: Reserved																																								
		<table border="1"> <thead> <tr> <th>Peaking (CR9A[6])</th> <th>Application control</th> <th>Inside window</th> <th>Outside window</th> </tr> </thead> <tbody> <tr> <td>0</td> <td>X</td> <td>bypass</td> <td>bypass</td> </tr> <tr> <td>1</td> <td>CR61-0C[5:4]=00 CR60[6]=0</td> <td>Peaking</td> <td>Peaking</td> </tr> <tr> <td>1</td> <td>CR61-0C[5:4]=01 && CR60[6]=1</td> <td>Peaking</td> <td>bypass</td> </tr> <tr> <td>1</td> <td>CR61-0C[5:4]=10 && CR60[6]=1</td> <td>bypass</td> <td>Peaking</td> </tr> </tbody> </table>	Peaking (CR9A[6])	Application control	Inside window	Outside window	0	X	bypass	bypass	1	CR61-0C[5:4]=00 CR60[6]=0	Peaking	Peaking	1	CR61-0C[5:4]=01 && CR60[6]=1	Peaking	bypass	1	CR61-0C[5:4]=10 && CR60[6]=1	bypass	Peaking																				
Peaking (CR9A[6])	Application control	Inside window	Outside window																																							
0	X	bypass	bypass																																							
1	CR61-0C[5:4]=00 CR60[6]=0	Peaking	Peaking																																							
1	CR61-0C[5:4]=01 && CR60[6]=1	Peaking	bypass																																							
1	CR61-0C[5:4]=10 && CR60[6]=1	bypass	Peaking																																							

Address: 61-0D Highlight Window Control 1
Default : 00h

Bit	Mode	Function
-----	------	----------

7:6	R/W	<p>sRGB application control</p> <p>00: sRGB used on full region</p> <p>01: sRGB used inside highlight window</p> <p>10: sRGB used outside highlight window</p> <p>11: Reserved</p> <table border="1"> <thead> <tr> <th>sRGB (CR62[2])</th> <th>Application control</th> <th>Inside window</th> <th>Outside window</th> </tr> </thead> <tbody> <tr> <td>0</td> <td>X</td> <td>bypass</td> <td>bypass</td> </tr> <tr> <td>1</td> <td>CR61-0D[7:6]=00 CR60[6]=0</td> <td>sRGB</td> <td>sRGB</td> </tr> <tr> <td>1</td> <td>CR61-0D[7:6]=01 && CR60[6]=1</td> <td>sRGB</td> <td>bypass</td> </tr> <tr> <td>1</td> <td>CR61-0D[7:6]=10 && CR60[6]=1</td> <td>bypass</td> <td>sRGB</td> </tr> </tbody> </table>	sRGB (CR62[2])	Application control	Inside window	Outside window	0	X	bypass	bypass	1	CR61-0D[7:6]=00 CR60[6]=0	sRGB	sRGB	1	CR61-0D[7:6]=01 && CR60[6]=1	sRGB	bypass	1	CR61-0D[7:6]=10 && CR60[6]=1	bypass	sRGB
sRGB (CR62[2])	Application control	Inside window	Outside window																			
0	X	bypass	bypass																			
1	CR61-0D[7:6]=00 CR60[6]=0	sRGB	sRGB																			
1	CR61-0D[7:6]=01 && CR60[6]=1	sRGB	bypass																			
1	CR61-0D[7:6]=10 && CR60[6]=1	bypass	sRGB																			
5:0	--	Reserved to 0																				

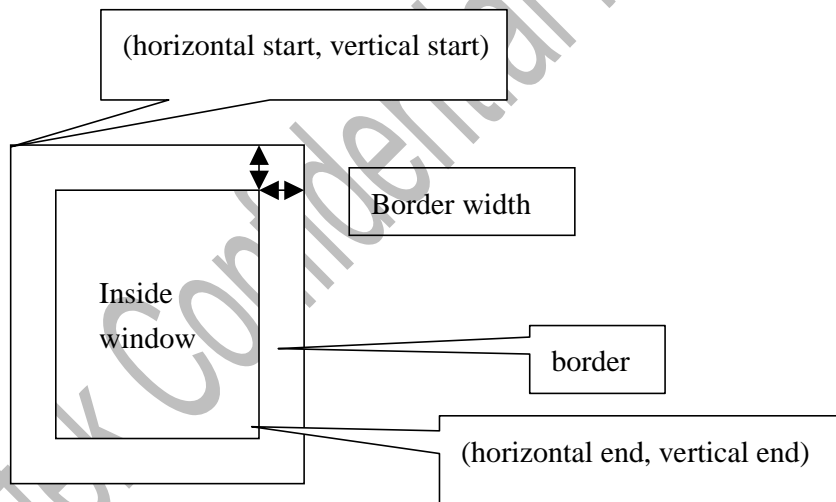

Inside window left-top point = (horizontal start + border width, vertical start + border width)

Inside window right-bottom point = (horizontal end, vertical end)

Border window left-top point = (horizontal start, vertical start)

Border window right-bottom point = (horizontal end+ border width, vertical end + border width)

Border = border window – inside window

Outside window = screen – border window

Color Processor Control

Address: 62
COLOR_CTRL (Color Control Register)
Default: 00h

Bit	Mode	Function
7	R/W	sRGB Coefficient Write Ready 0: Not ready or cleared after finished 1: Ready to write (wait for DVS to apply)
6	R/W	sRGB Precision 0: Normal (Default) 1: Multiplier Coefficient Bit Left Shift
5:3	R/W	sRGB Coefficient Write Enable 000: Disable 001: Write R Channel (RRH,RRL,RGH,RGL,RBH,RBL) (address reset to 0 when written) 010: Write G Channel (GRH,GBL,GGH,GGL,GBH,GBL) (address reset to 0 when written) 011: Write B Channel (BRH,BRL,BGH,BGL,BBH,BBL) (address reset to 0 when written) 100: R Offset 101: G Offset 110: B Offset
2	R/W	Enable sRGB Function 0: Disable (Default) 1: Enable
1	R/W	Enable Contrast Function: 0: disable the coefficient (Default) 1: enable the coefficient
0	R/W	Enable Brightness Function: 0: disable the coefficient (Default) 1: enable the coefficient

Address: 63
SRGB_ACCESS_PORT

Bit	Mode	Function
7:0	W	sRGB_COEF[7:0]

- I For Multiplier coefficient: 9 bit: 1 bit sign, 8 bit fractional part
- I For filling multiplier coefficient, the sequence should be SIGN bit (High Byte), 8 bit fractional (Low Byte)
- I For Offset Coefficient: 1 sign, 5 integer, 2 bit fractional part
- I sRGB output saturation to 1023 and Clamp to 0
- I sRGB Output is 10 bit

$$\begin{bmatrix} R' \\ G' \\ B' \end{bmatrix} = \begin{bmatrix} 1+RR & RG & RB \\ GR & 1+GG & GB \\ BR & BG & 1+BB \end{bmatrix} \begin{bmatrix} R + Roffset \\ G + Goffset \\ B + Boffset \end{bmatrix}$$

Contrast/Brightness Coefficient

Address: 64 Contrast /Brightness Access Port Control

Default: 00h

Bit	Mode	Function
7	R/W	Enable Contrast /Brightness access port
6	R/W	sRGB multiplier coefficient precision 0: 1-bit Shift-left (Default) 1: 2-bit Shift-left
5:4	--	Reserved
3:0	R/W	Contrast /Brightness port address

Access data port continuously will get address auto increase.

Address: 65-00 BRI_RED_COE (Set A)

Bit	Mode	Function
7:0	R/W	Brightness Red Coefficient: Valid range: -128(00h) ~ 0(80h) ~ +127(FFh)

Address: 65-01 BRI_GRN_COE (Set A)

Bit	Mode	Function
7:0	R/W	Brightness Green Coefficient: Valid range: Valid range: -128(00h) ~ 0(80h) ~ +127(FFh)

Address: 65-02 BRI_BLU_COE (Set A)

Bit	Mode	Function
7:0	R/W	Brightness Blue Coefficient: Valid range: -128(00h) ~ 0(80h) ~ +127(FFh)

Address: 65-03 CTS_RED_COE (Set A)

Bit	Mode	Function
7:0	R/W	Contrast Red Coefficient: Valid range: 0(00h) ~ 1(80h) ~ 2(FFh)

Address: 65-04 CTS_GRN_COE (Set A)

Bit	Mode	Function
7:0	R/W	Contrast Green Coefficient: Valid range: 0(00h) ~ 1(80h) ~ 2(FFh)

Address: 65-05 CTS_BLU_COE (Set A)

Bit	Mode	Function
7:0	R/W	Contrast Blue Coefficient: Valid range: 0(00h) ~ 1(80h) ~ 2(FFh)

Address: 65-06 BRI_RED_COE (Set B)

Bit	Mode	Function
7:0	R/W	Brightness Red Coefficient: Valid range: -128(00h) ~ 0(80h) ~ +127(FFh)

Address: 65-07 BRI_GRN_COE (Set B)

Bit	Mode	Function
7:0	R/W	Brightness Green Coefficient: Valid range: Valid range: -128(00h) ~ 0(80h) ~ +127(FFh)

Address: 65-08 BRI_BLU_COE (Set B)

Bit	Mode	Function
7:0	R/W	Brightness Blue Coefficient: Valid range: -128(00h) ~ 0(80h) ~ +127(FFh)

Address: 65-09 CTS_RED_COE (Set B)

Bit	Mode	Function
7:0	R/W	Contrast Red Coefficient: Valid range: 0(00h) ~ 1(80h) ~ 2(FFh)

Address: 65-0A CTS_GRN_COE (Set B)

Bit	Mode	Function
7:0	R/W	Contrast Green Coefficient: Valid range: 0(00h) ~ 1(80h) ~ 2(FFh)

Address: 65-0B CTS_BLU_COE (Set B)

Bit	Mode	Function
7:0	R/W	Contrast Blue Coefficient: Valid range: 0(00h) ~ 1(80h) ~ 2(FFh)

When highlight window is disable, coefficient set A is used.

Gamma Control

Address: 66 GAMMA_PORT

Bit	Mode	Function
7:0	W	Access port for gamma correction table

Address: 67 GAMMA_CTRL Default: 00h

Bit	Mode	Function
-----	------	----------

7	R/W	Enable Access Channels for Gamma Correction Coefficient: 0: disable these channels (Default) 1: enable these channels
6	R/W	Gamma table enable 0: by pass (Default) 1: enable
5:4	R/W	Color Channel of Gamma Table 00: Red Channel (Default) 01: Green Channel 10: Blue Channel 11: Red/Green/Blue Channel (R/G/B Gamma are the same)
3:1	--	Reserved to 0
0	R/W	Gamma Access Type 0: access compact gamma table (Default) 1: access full gamma table

1 Access Gamma_Access register will reset GAMMA_PORT index.

Address: 68 **GAMMA_BIST (Color Control Register)** **Default: 00h**

Bit	Mode	Function
7	R/W	Test_mode 0: Disable, dither_out = dither_result[9:2]; // truncate to integer number (Default) 1: Enable, dither_out = dither_result[7:0]; // propagate decimal part for test
6	R/W	sRGB precision 0: Normal (Default) 1: Multiplier coefficient 1-bit or 2-bit shift-left (depend on CR64[6])
5:4	--	Reserved to 0
3:2	R/W	Gamma BIST select 00: BIST Disable (Default) 01: Red LUT 10: Green LUT 11: Blue LUT
1	R/W	Gamma BIST_Progress 0: BIST is done (Default) 1: BIST is running
0	R	Gamma BIST Test Result 0: SRAM Fail 1: SRAM OK

Dithering Control

Register:: DITHERING_DATA_ACCESS					0x69
Name	Bits	Read/Write	Reset State	Comments	Config
DITHERING_DATA_ACCESS	7:0	W	0	Refer to following description	

Register:: DITHERING_CTRL1					0x6A
Name	Bits	Read/Write	Reset State	Comments	Config
Dither_Access	7:6	R/W	0	Enable Access Control 00: disable (Default) 01: enable access dithering sequence table 10: enable access dithering table 11: enable access temporal offset	
Dither_en	5	R/W	0	Enable Dithering Function 0: disable (Default) 1: enable	
Dither_temp	4	R/W	0	Temporal Dithering 0: Disable (Default) 1: Enable	
Dither_table	3	R/W	0	Dithering Table Value Sign 0: unsigned 1: signed (2's complement)	
Dither_mode	2	R/W	0	Dithering Mode 0: New (Default) 1: Old	
Dither_V_Fram_M	1	R/W	0	Vertical Frame Modulation 0: Disable (Default) 1: Enable	
Dither_VH_Fram_M	0	R/W	0	Horizontal Frame Modulation 0: Disable (Default) 1: Enable	

Address 0x6B is reserved

Overlay/Color Palette/Background Color Control

Address: 6C OVERLAY_CTRL (Overlay Display Control Register) Default: 00h

Bit	Mode	Function
7:6	--	Reserved to 0
5	R/W	Background color access enable 0: Disable(Reset CR6D Write Pointer to R)

		1: Enable
4:2	R/W	Alpha blending level (Also enable OSD frame control register 0x003 byte 1[3:2]) 000: Disable (Default) 001 ~111: 1/8~ 7/8
1	R/W	Overlay Sampling Mode Select: 0: single pixel per clock (Default) 1: dual pixels per clock (The OSD will be zoomed 2X in horizontal scan line)
0	R/W	Overlay Port Enable: 0: Disable (Default) 1: Enable Turn off <u>overlay enable</u> and <u>switch to background</u> simultaneously when auto switch to background.

Address: 6D **BGND_COLOR_CTRL** **Default: 00h**

Bit	Mode	Function
7:0	R/W	Background color RGB 8-bit value[7:0]

- l There are 3 bytes color select of background R, G, B, once we enable Background color access channel(CR6C[5]) and the continuous writing sequence is R/G/B

Address: 6E **OVERLAY_LUT_ADDR (Overlay LUT Address)** **Default: 00h**

Bit	Mode	Function
7	R/W	Enable Overlay Color Plate Access: 0: Disable (Default) 1: Enable
6	R/W	Reserved to 0
5:0	R/W	Overlay 16x24 Look-Up-Table Write Address [5:0]

- l Auto-increment while every accessing "Overlay LUT Access Port".

Address: 6F **COLOR_LUT_PORT (LUT Access Port)**

Bit	Mode	Function
7:0	W	Color Palette 16x24 Look-Up-Table access port [7:0]

- l Using this port to access overlay color plate which addressing by the above registers.

- l The writing sequence into LUT is [R0, G0, B0, R1, G1, B1, ... R15, G15, and B15] and the address counter will be automatic increment and circular from 0 to 47.

Image Auto Function

Address: 70 **H_BOUNDARY_H**

Bit	Mode	Function
7	--	Reserved

6:4	R/W	Horizontal Boundary Start: High Byte [10:8]
3:0	R/W	Horizontal Boundary End: High Byte [11:8]

Address: 71 H_BOUNDARY_STA_L

Bit	Mode	Function
7:0	R/W	Horizontal Boundary Start: Low Byte [7:0]

Address: 72 H_BOUNDARY_END_L

Bit	Mode	Function
7:0	R/W	Horizontal Boundary End: Low Byte [7:0]

Address: 73 V_BOUNDARY_H

Bit	Mode	Function
7	--	Reserved
6:4	R/W	Vertical Boundary Start: High Byte [10:8]
3:0	R/W	Vertical Boundary End: High Byte [11:8]

Vertical boundary search should be limited by Vertical boundary start.

Address: 74 V_BOUNDARY_STA_L

Bit	Mode	Function
7:0	R/W	Vertical Boundary Start: Low Byte [7:0]

Address: 75 V_BOUNDARY_END_L

Bit	Mode	Function
7:0	R/W	Vertical Boundary End: Low Byte [7:0]

Address: 76 RED_NOISE_MARGIN (Red Noise Margin Register)

Bit	Mode	Function
7:2	R/W	Red pixel noise margin setting register
1:0	--	Reserved to 0

Address: 77 GRN_NOISE_MARGIN (Green Noise Margin Register)

Bit	Mode	Function
7:2	R/W	Green pixel noise margin setting register
1:0	--	Reserved to 0

Address: 78 BLU_NOISE_MARGIN (Blue Noise Margin Register)

Bit	Mode	Function
7:2	R/W	Blue pixel noise margin setting register
1:0	--	Reserved to 0

Address: 79 DIFF_THRESHOLD

Bit	Mode	Function
-----	------	----------

7:0	R/W	Difference Threshold (Threshold for DIFF no matter CR7D[2] = 0 or 1)
-----	-----	--

Address: 7A **AUTO_ADJ_CTRL0** **Default: 00h**

Bit	Mode	Function
7	R/W	Field_Select_Enable: Auto-Function only active when Even or Odd field. 0: Disable (Default) 1: Enable
6	R/W	Field_Select: Select Even or Odd field. Active when Field_Select_Enable . 0: Active when ODD signal is "0" (Default) 1: Active when ODD signal is "1"
5	R/W	Low Pass Filter (121-LPF) 0: Disable (Default) 1: Enable
4	R/W	Auto Function Acceleration : 0: Disable (Default) 1: Enable For auto-balance (CR7D[1]=0), this function must be disabled.
3:2	R/W	Vertical boundary search: 00: 1 pixel over threshold (Default) 01: 2 pixel over threshold 10: 4 pixel over threshold 11: 8 pixel over threshold
1:0	R/W	Color Source Select for Detection: 00: B color (Default) 01: G color 10: R color 11: ALL (the result will be divided by 2)

Address: 7B **HW_AUTO_PHASE_CTRL0** **Default: 00h**

Bit	Mode	Function
7:3	R/W	Number of Auto-Phase Step (Valut+1) (How many times (steps reference CR7B[2:0]) jumps when using Hardware Auto)
2:0	R/W	Hardware Auto Phase Step 000: Step =1 (Default) 001 Step =2 010: Step =4 011: Step =8

		1xx: Step =16
--	--	---------------

Address: 7C **HW_AUTO_PHASE_CTRL1** **Default: 00h**

Bit	Mode	Function
7	R/W	Hardware Auto Phase Select Trigger 0: IVS 1: Vertical Boundary End
6:0	R/W	Initial phase of Auto-Phase (0~127)

Address: 7D **AUTO_ADJ_CTRL1** **Default: 00h**

Bit	Mode	Function
7	R/W	Measure Digital Enable Info when boundary search active 0: Normal Boundary Search (Default) 1: Digital Enable Info Boundary Search.(Digital mode)
6	R/W	Hardware / Software Auto Phase Switch 0: Software (Default) 1: Hardware
5	R/W	Color Max or Min Measured Select: 0: MIN color measured (Only when Balance-Mode, result must be complemented) (Default) 1: MAX color measured
4	R/W	Accumulation or Compare Mode 0: Compare Mode (Default) 1: Accumulation Mode
3	R/W	Mode Selection For SOD 0: SOD Edge Mode (Default) 1: SOD Edge + Pulse Mode
2	R/W	Type Selection For DIFF 0: DIFF 1: (DIFF/4) * (DIFF/4) Total result for each color is divided by 8 if this bit is 1.
1	R/W	Function (Phase/Balance) Selection 0: Auto-Balance (Default) 1: Auto-Phase
0	R/W	Start Auto-Function Tracking Function: 0: stop or finished (Default) 1: start

Control Table/ Function	Sub-Function	CR7D.6	CR7D.5	CR7D.4	CR7D.3	CR7D.1	CR7C
Auto-Balance	Max pixel	X	1	0	0	0	X
	Min pixel	X	0	0	0	0	X
Auto-Phase Type	Mode1	1	1	1	0	1	Th
	Mode2	1	1	1	1	1	Th
Accumulation	All pixel	1	1	1	0	0	0

Table 1 Auto-Tracking Control Table

Address: 7E VER_START_END_H (Active region vertical start Register)

Bit	Mode	Function
7:4	R	Active region vertical START measurement result: bit[11:8]
3:0	R	Active region vertical END measurement result: bit[11:8]

Address: 7F VER_START_L (Active region vertical start Register)

Bit	Mode	Function
7:0	R	Active region vertical start measurement result: bit[7:0]

Address: 80 VER_END_L (Active region vertical end Register)

Bit	Mode	Function
7:0	R	Active region vertical end measurement result: bit[7:0]

Address: 81 H_START_END_H (Active region horizontal start Register)

Bit	Mode	Function
7:4	R	Active region horizontal START measurement result: bit [11:8]
3:0	R	Active region horizontal END measurement result: bit[11:8]

Address: 82 H_START_L (Active region horizontal start Register)

Bit	Mode	Function
7:0	R	Active region horizontal start measurement result: bit[7:0]

Address: 83 H_END_L (Active region horizontal end Register)

Bit	Mode	Function
7:0	R	Active region horizontal end measurement result: bit[7:0]

Address: 84 AUTO_PHASE_3 (Auto phase result byte3 register)

Bit	Mode	Function
7:0	R	Auto phase measurement result: bit[31:24]

Address: 85 AUTO_PHASE_2 (Auto phase result byte2 register)

Bit	Mode	Function
7:0	R	Auto phase measurement result: bit[23:16]

Address: 86 AUTO_PHASE_1 (Auto phase result byte1 register)

Bit	Mode	Function
7:0	R	Auto phase measurement result: bit[15:8]

Address: 87 **AUTO_PHASE_0 (Auto phase result byte0 register)**

Bit	Mode	Function
7:0	R	Auto phase measurement result: bit[7:0] The measured value of R or G or B color max or min. (Auto-Balance)

Address 0x88~0x8A are reserved

Realtek Confidential for GM Only

Embedded Timing Controller
Address: 8B **TCON_ADDR_PORT** **Default: 00h**

Bit	Mode	Function
7:0	R/W	Address port for embedded TCON access

Address: 8C **TCON_DATA_PORT** **Default: 00h**

Bit	Mode	Function
7:0	R/W	Data port for embedded TCON access

Address: 8C-00 **TC_CTRL0 (Timing Controller control register1)** **Default: 01h**

Bit	Mode	Function
7	R/W	Enable Timing Controller Function (Global) 0: Disable (Default) 1: Enable All TCON pins will be initialized when enabled and goes low when disabled.
6	R/W	TCON [n] Toggle Function Reset 0: Not reset (Default) 1: reset by DVS
5	R/W	Inactive Period Data Controlled by internal TCON [13] 0: DEN (Default) 1: TCON [13]
4	R/W	TCON_HS compensation 0: Real TCON_HS = TCON_HS-4 1: Real TCON_HS = TCON_HS-27 If setting TCON_HS > DH_Total, then setting TCON_HS must subtract DH_Total.
3:2	---	Reserve to 0
1:0	R/W	DISP_TYPE 00: TTL 01: LVDS (Default) others are reserved

Address: 8C-01 **TC_CTRL1 (Timing Controller control register1)** **Default: 00h**

Bit	Mode	Function
7:0	R/W	Reserved to 0

Address: 8C-02 **Pixel Threshold MSB** **Default: 00h**

Bit	Mode	Function
7	R/W	2-Line Sum of Difference Threshold 1 Value: bit [8], ie:TH1 (also refer to CR8C-03)

6	R/W	2-Line Sum of Difference Threshold 2 Value: bit [8], ie:TH2 (also refer to CR8C-04)
5:1	R/W	Reserved to 0
0	R/W	Anti-Flicker Measure Mode 0: Dot-Based (Original) 1: Pixel-Based

Address: 8C-03 Pixel Threshold High Value for Smart Polarity (TH1) Default: 00h

Bit	Mode	Function
7:0	R/W	2 line Sum of Difference Threshold 1 Value: bit [7:0], ie:TH1 (Also refer to CR8C-02[7])

Address: 8C-04 Pixel Threshold Low Value for Smart Polarity (TH2) Default: 00h

Bit	Mode	Function
7:0	R/W	2 line Sum of Difference Threshold 2 Value: bit [7:0], ie:TH2 (Also refer to CR8C-02[6])

Address: 8C-05 Line Threshold Value for Smart Polarity Default: 00h

Bit	Mode	Function
7	R/W	Measure Dot Pattern over Threshold 1: Run. Auto: always measure (Reference to CR8C-05[5]) Manual: start to measure, clear after finish 0: Stop
6	R	Dot Pattern Sum of Difference Measure Result 1: Over threshold 0: Under threshold
5	R/W	Anti-Flicker Auto-Measure Control 1: Auto 0: Manual
4:0	R/W	Over Difference Line Threshold Value: bit [8:4] Notes: Bit[3:0] are zeros

Over Difference Line Threshold Value shall not exceed 0x190.

Address: 8C-06~07 Reserved to 0

TCON Horizontal/Vertical Timing Setting

Address: 8C-08 TCON [0]_VS_LSB (TCON [0] Vertical Start LSB Register)

Bit	Mode	Function
7:0	W	Line number [7:0] at which TCON control generation begins

Address: 8C-09 TCON [0]_VS_MSB (TCON [0] Vertical Start/End MSB Register)

Bit	Mode	Function
-----	------	----------

7:4	W	Line number [11:8] at which TCON control generation ends
3:0	W	Line number [11:8] at which TCON control generation begins

Address: 8C-0A TCON [0]_VE_LSB (TCON [0] Vertical End LSB Register)

Bit	Mode	Function
7:0	W	Line number [7:0] at which TCON control generation ends

Address: 8C-0B TCON [0]_HS_LSB (TCON [0] Horizontal Start LSB Register)

Bit	Mode	Function
7:0	W	Pixel count [7:0] at which TCON goes active

Address: 8C-0C TCON [0]_HS_MSB (TCON [0] Horizontal Start/End MSB Register)

Bit	Mode	Function
7:4	W	Pixel count [11:8] at which TCON goes inactive
3:0	W	Pixel count [11:8] at which TCON goes active

To be triggered on rising edge of the DCLK

Address: 8C-0D TCON [0]_HE_LSB (TCON [0] Horizontal End LSB Register)

Bit	Mode	Function
7:0	W	Pixel count [7:0] at which TCON goes inactive

If the register number is large than display format, the horizontal component is always on.

Real TCON_HS = TCON_HS-4, Real TCON_HE = TCON_HE-4

Address: 8C-0E TCON [0]_CTRL (TCON [0] Control Register) **Default: 00h**

Bit	Mode	Function
7	R/W	TCON [n] Enable (Local) 0: Disable (TCON [n] output clamp to '0') (Default) 1: Enable
6	R/W	Polarity Control 0: Normal output (Default) 1: Inverted output
5:4	--	Reserved to 0
3	R/W	Toggle Circuit Enable/Disable 0: Normal TCON output (Default) 1: Toggle Circuit enable When using toggle circuit enable mode, the TCON[n] will be 1 clock earlier than TCON[n-1] and then toggling together, finally output will be 1 clock delay comparing to toggling result.
2:0	R/W	TCON [13:10] & TCON [7:4] (TCON Combination Select) TCON [13] has inactive data controller function. TCON [13]-[10] has dot masking function

	<p>TCON [7] has flicking reduce function.</p> <p>000: Normal TCON output (Default)</p> <p>001: Select TCON [n] “AND” with TCON [n-1]</p> <p>010: Select TCON [n] “OR” with TCON [n-1]</p> <p>011: Select TCON [n] “XOR” with TCON [n-1]</p> <p>100: Select TCON [n-1] rising edge as toggle trigger signal (when toggle enable)</p> <p>101: Select TCON [n-1] rising edge as toggle trigger signal, then “AND” (when toggle enable)</p> <p>110: Select TCON [n-1] rising edge as toggle trigger signal, then “OR” (when toggle enable)</p> <p>111: Select TCON [n] and TCON [n-1] on alternating frames.</p> <hr/> <p>TCON [9:8] (TCON Combination Select)</p> <p>000: Normal TCON output</p> <p>001: Select TCON [n] “AND” with TCON [n-1]</p> <p>010: Select TCON [n] “OR” with TCON [n-1]</p> <p>011: Select TCON [n] “XOR” with TCON [n-1]</p> <p>100: Select TCON [n-1] rising edge as toggle trigger signal (when toggle enable)</p> <p>101: Select TCON [n-1] rising edge as toggle trigger signal, then “AND” (when toggle enable)</p> <p>110: Select TCON [n-1] rising edge as toggle trigger signal, then “OR” (when toggle enable)</p> <p>111: Select TCON [n] and TCON [n-1] reference ODD signal as alternating frames.</p> <hr/> <p>TCON [3] (TCON Combination Select)</p> <p>000: Normal TCON output</p> <p>001: Select TCON [3] “AND” with TCON [2]</p> <p>010: Select TCON [3] “OR” with TCON [2]</p> <p>011: Select TCON [3] “XOR” with TCON [2]</p> <p>100: Select TCON [2] rising edge as toggle trigger signal (when toggle enable)</p> <p>101: Select TCON [2] rising edge as toggle trigger signal, then “AND” (when toggle enable)</p> <p>110: Select TCON [2] rising edge as toggle trigger signal, then “OR” (when toggle enable)</p> <p>111: Select reset(ODD=0) or set(ODD=1) TCON [3] by DVS, when toggle function enable</p> <hr/> <p>TCON [2] (Clock Toggle Function)//toggle function is inactive</p> <p>00x: Normal TCON output</p> <p>010: Select DCLK/2 when TCON [2] is “0”</p> <p>011: Select DCLK/2 when TCON [2] is “1”</p> <p>100: Select DCLK/4 when TCON [2] is “0”</p> <p>101: Select DCLK/4 when TCON [2] is “1”</p> <p>110: Select DCLK/8 when TCON [2] is “0”</p>
--	---

		111: Select DCLK/8 when TCON [2] is “1” <hr/> TCON [1] xx0: Normal TCON output xx1: Reverse-Control Signal output <hr/> TCON [0] 00x: Normal TCON output 010: EVEN “REV” 18/24-bit function (“REV0” on TCON [0]) ODD “REV” 18/24-bit function (“REV1” on TCON [1]) 011: ALL “REV” 36/48-bit function (“REV” on TCON [0], can also on TCON [1]) 100: EVEN data Output Inversion Controlled by TCON [0] is “0” ODD data Output Inversion Controlled by TCON [1] is “0” 101: EVEN data Output Inversion Controlled by TCON [0] is “1” ODD data Output Inversion Controlled by TCON [1] is “1”
--	--	--

Dot Masking

Address: 8C-5F/67/6F/77 **TC_DOT_MASKING_CTRL** **Default:** 00h

Bit	Mode	Function
7:3	R/W	Reserved to 0
2	R/W	Red Dot Masking Enable 0: Disable (Default) 1: Enable
1	R/W	Green Dot Masking Enable 0: Disable (Default) 1: Enable
0	R/W	Blue Dot Masking Enable 0: Disable (Default) 1: Enable

When applying dot masking, the timing setting for TCON will be

Real TCON_Mask_STA = TCON_STA+2

Real TCON_Mask_END = TCON_END +2

TCON [0] ~ TCON [13] Control Registers Address Map

Address	Data(# bits)	Default
0A,09,08	TCON [0]_VS_REG (11)	
0D,0C,0B	TCON [0]_HS_REG (11)	

0E	TCON [0]_CTRL_REG	00
0F	Reserved	
12,11,10	TCON [1]_VS_REG (11)	
15,14,13	TCON [1]_HS_REG (11)	
16	TCON [1]_CTRL_REG	00
17	Reserved	
1A,19,18	TCON [2]_VS_REG (11)	
1D,1C,1B	TCON [2]_HS_REG (11)	
1E	TCON [2]_CTRL_REG	00
1F	Reserved	
22,21,20	TCON [3]_VS_REG (11)	
25,24,23	TCON [3]_HS_REG (11)	
26	TCON [3]_CTRL_REG	00
27	Reserved	
2A,29,28	TCON [4]_VS_REG (11)	
2D,2C,2B	TCON [4]_HS_REG (11)	
2E	TCON [4]_CTRL_REG	00
2F	Reserved	
32,31,30	TCON [5]_VS_REG (11)	
35,34,33	TCON [5]_HS_REG (11)	
36	TCON [5]_CTRL_REG	00
37	Reserved	
3A,39,38	TCON [6]_VS_REG (11)	
3D,3C,3B	TCON [6]_HS_REG (11)	
3E	TCON [6]_CTRL_REG	00
3F	Reserved	
42,41,40	TCON [7]_VS_REG (11)	
45,44,43	TCON [7]_HS_REG (11)	

46	TCON [7]_CTRL_REG	00
47	Reserved	
4A,49,48	TCON [8]_VS_REG (11)	
4D,4C,4B	TCON [8]_HS_REG (11)	
4E	TCON [8]_CTRL_REG	00
4F	Reserved	
52,51,50	TCON [9]_VS_REG (11)	
55,54,53	TCON [9]_HS_REG (11)	
56	TCON [9]_CTRL_REG	00
57	Reserved	
5A,59,58	TCON [10]_VS_REG (11)	
5D,5C,5B	TCON [10]_HS_REG (11)	
5E	TCON [10]_CTRL_REG	00
5F	TCON [10]_CTRL_REG	
62,61,60	TCON [11]_VS_REG (11)	
65,64,63	TCON [11]_HS_REG (11)	
66	TCON [11]_CTRL_REG	00
67	TCON [11]_CTRL_REG	00
6A,69,68	TCON [12]_VS_REG (11)	
6D,6C,6B	TCON [12]_HS_REG (11)	
6E	TCON [12]_CTRL_REG	00
6F	TCON [12]_CTRL_REG	00
72,71,70	TCON [13]_VS_REG (11)	
75,74,73	TCON [13]_HS_REG (11)	
76	TCON [13]_CTRL_REG	00
77	TCON [13]_CTRL_REG	00

Control for LVDS
Address: 8C-A0
LVDS_CTRL0
Default: 00h

Bit	Mode	Function
7:6	--	Reserved to 0
5	R/W	Power Up LVDS Even-Port 0: Power down (Default) 1: Normal
4	R/W	Power Up LVDS Odd-Port 0: Power down (Default) 1: Normal
3:2	R/W	Watch Dog Model 00: Enable Watch Dog(Default) 01: Keep PLL VCO = 1V 1x: Disable Watch Dog
1	R/W	ENVBPBL: Enable VCO_D2S Current Up 0: disable (Default) 1: enable
0	R	Watch Dog Control Flag 0: Watch dog not active (Default) 1: Watch dog active, Reset PLL and set VCO = 1V

Address: 8C-A1
LVDS_CTRL1
Default: 14h

Bit	Mode	Function
7	R/W	BCKPOLARL: Inverse the CK7X 0: no inverse 1: inverse
6	R/W	DCKPOLARL: Inverse the CK7X 0: no inverse 1: inverse
5:3	R/W	STSTL [2:0]: select test attribute 000: WD 001: VCOM 010: IB40u (default) 011: IBVOCM 100: PLLTST-fbak 101: PLLTST-fin 110: LVTST-CKDIN 111: LVTST-LVDSIN[6]

2:0	R/W	RSDS / LVDS Output Common Mode (Default: 100)
-----	-----	--

Address: 8C-A2 **LVDS_CTRL2** **Default: 43h**

Bit	Mode	Function
7:6	R/W	SBGL 00: 1.14V 01: 1.20V (Default) 10: 1.27V 11: 1.33V
5	R/W	ENIB40UX2L: Double the LVDS/RSDS output swing 0: 1X 1: 2X
4	R/W	SIBXL : select 20uA source 0: from Bandgap (Default) 1: from ADC
3	R/W	PLL lock edge 0: positive 1: negative
2:0	R/W	Bias Generator Adjust (011)

Address: 8C-A3 **LVDS_CTRL3** **Default: 1Ch**

Bit	Mode	Function
7	R/W	LVDS Differential pair PN swap (data) (Also refer to CR29[6:4]) 0: No Swap (Default) 1: Swap
6	R/W	LVDS Mirror 0: Normal (TXE3+, TXE3-, TXEC+, TXEC-, TXE2+, TXE2-, TXE1+, TXE1-, TXE0+, TXE0-, TXO3+, TXO3-, TXOC+, TXOC-, TXO2+, TXO2-, TXO1+, TXO1-, TXO0+, TXO0-) 1: Mirror (TXE0-, TXE0+, TXE1-, TXE1+, TXE2-, TXE2+, TXEC-, TXEC+, TXE3-, TXE3+, TXO0-, TXO0+, TXO1-, TXO1+, TXO2-, TXO2+, TXOC-, TXOC+, TXO3-, TXO3+)
5:3	R/W	SIL [2:0]: PLL charge pump current ($I=5\mu A+5\mu A*\text{code}$) (Default: 011)
2:1	R/W	SRL [1:0]: PLL resistor ($R=6K+2K*\text{code}$) (Default: 10)
0	R/W	BMTS: Bit-Mapping Table Select 0: Table 1 (Default) 1: Table 2

Address: 8C-A4 **LVDS_CTRL4** **Default: 80h**

Bit	Mode	Function
7:6	R/W	E_RSV: even port reserve signal select 11: Always '1' 10: Always '0'

		01: TCON [11] 00: PWM_0
5:4	R/W	E_DEN : even port data enable signal select 11: Always '1' 10: Always '0' 01: TCON [9] 00: DENA
3:2	R/W	E_VS : even port VS signal select 11: Always '1' 10: Always '0' 01: TCON [7] 00: DVS
1:0	R/W	E_HS : even port HS signal select 11: Always '1' 10: Always '0' 01: TCON [5] 00: DHS

Address: 8C-A5
LVDS_CTRL5
Default: 80h

Bit	Mode	Function
7:6	R/W	O_RSV : odd port reserve signal select 11: Always '1' 10: Always '0' 01: TCON [13] 00: PWM_1
5:4	R/W	O_DEN : odd port data enable signal select 11: Always '1' 10: Always '0' 01: TCON [9] 00: DENA
3:2	R/W	O_VS : odd port VS signal select 11: Always '1' 10: Always '0' 01: TCON [7] 00: DVS
1:0	R/W	O_HS : odd port HS signal select 11: Always '1' 10: Always '0'

		01: TCON [5] 00: DHS
--	--	-------------------------

Embedded OSD

Address: 90 **OSD_ADDR_MSB (OSD Address MSB 8-bit)**

Bit	Mode	Function
7:0	R/W	OSD MSB 8-bit address

Address: 91 **OSD_ADDR_LSB (OSD Address LSB 8-bit)**

Bit	Mode	Function
7:0	R/W	OSD LSB 8-bit address

Address: 92 **OSD_DATA_PORT (OSD Data Port)**

Bit	Mode	Function
7:0	W	Data port for embedded OSD access

Refer to the embedded OSD application note for the detailed.

Address: 93 **OSD_SCRAMBLE** **Default: 05h**

Bit	Mode	Function
7	R/W	BIST Start 0: stop (Default) 1: start (auto clear)
6	R	BIST Result 0: fail (Default) 1: success
5	R	MCU writes data when OSD ON status (Queue 1 byte data) 0: MCU writes data to OSD but not to real position (There is one level buffer here) 1: MCU doesn't write data, or data has been written to real position
4	R	Double Buffer Write Status 0: double buffer write out is finish, or data write to double buffer is not ready, or no double buffer function. 1: after data write to dbuf and before dbuf write out, such that double buffer is busy.
3	R/W	OSDADRHSB 0: If initial address lower than or equal to 12K 1: If initial address higher than 12K The bit will be designed to control 16.5K bytes SRAM. However it will have no effect for WINDOW setting. Also please remember to set {OSDADRHSB, OSDADRMSB(CR90), OSDADRLSB(CR91) } again while you like to R/W a new address.

2:0	R/W	Double buffer depth (Default=6) 000~101=>1~6
-----	-----	--

Address: 94 **OSD_TEST**

Bit	Mode	Function
7:0	R/W	Testing Pattern

Address:95~97 Reserved

Digital Filter

Address: 98 **DIGITAL_FILTER_CTRL** **Default: 00h**

Bit	Mode	Function
7:4	R/W	Access Port Write Enable 0000: disable 0001: phase access port 0010: negative smear access port 0011: positive smear access port 0100: negative ringing access port 0101: positive ringing access port 0110: mismatch access port 0111: Y(B)/Pb(G)/Pr(R) channel digital filter enable 1xxx: noise reduction access port
3:2	R/W	Two condition occur continuous (ringing to smear) 00: disable(hardware is off , depend on firmware) 01: only reduce ringing condition 10: only reduce smear condition 11: no adjust (hardware is on, but do nothing)
1	R/W	When noise reduction and mismatch occur, select 0: mismatch 1: noise reduction
0	--	Reserved to 0

Address: 99 **DIGITAL_FILTER_PORT** **Default: 00h**

DIGITAL_FILTER_CTRL[7:4] = 0111

Bit	Mode	Function
7	R/W	Y EN (G): function enable 0: function disable 1: function enable

6	R/W	Pb EN (B) : function enable 0: function disable 1: function enable
5	R/W	Pr EN (R) : function enable 0: function disable 1: function enable
4	R/W	Initial value: 0: raw data 1: extension
3:0	--	Reserved to 0

DIGITAL_FILTER_CTRL[7:4] = 000 ~ 110		
Bit	Mode	Function
7	R/W	EN : function enable 0: function disable 1: function enable
6:4	R/W	THD_OFFSET Threshold value of phase and mismatch and noise reduction or offset value of smear and ringing
3:2	R/W	DIV : divider value of phase and mismatch or offset value of smear and ringing 00: 0 01: 1 10: 2 11: 3
1:0	--	Reserved to 0

THD_OFFSET define:

The THD value definition of phase enhance function

Bit6~4	000	001	010	011	100	101	110	111
Value	112	128	144	160	176	192	208	224

The offset value definition of smear and ringing reduce function

Bit6~4	000	001	010	011	100	101	110	111
Value	no use	16	32	48	64	80	96	112

The THD value definition of mismatch enhance function

Bit6~4	000	XX1
Value	1	2

The THD value definition of noise reduction function

Bit6~4	000	001	010	011	100	101	110	111
--------	-----	-----	-----	-----	-----	-----	-----	-----

Value	0	1	2	3	4	5	6	7
-------	---	---	---	---	---	---	---	---

VBI

Register::VBI address port 0x9A					
Name	Bits	Read/Write	Reset State	Comments	config
VBI_ADDR_P	7:0	R/W	00	VBI address port	

Register::VBI data port 0x9B					
Name	Bits	Read/Write	Reset State	Comments	Config
VBI_Data_P	7:0	R/W	00	VBI data port	

Following VBI registers is assigned by VBI address port and VBI data port

Register::VBISL0_3 0xBF					
Name	Bits	Read/Write	Reset State	Comments	Config
Reserved	7:2	R/W	0	Reserved	
VBISL0_SRC_SE L	1	RW	0	Select the ADC source for VBI Slicer 1'b0 : ADC source from Video Decode 1'b1 : ADC source from YPbPr	
VBISL0_SYS625I	0	RW	0	Specify the Video System 1'b0 : NTSC for CC & CGMS Detection 1'b1 : PAL/SECAM for WSS Detection	

Register::VBISL0_2 0xC0					
Name	Bits	Read/Write	Reset State	Comments	Config
VBISL0_DATA_H LVL	7:0	R/W	0x60	DATA_HLVL: specify the data high level.	

Register::VBISL0_0 0xC1					
Name	Bits	Read/Write	Reset State	Comments	Config
Reserved	7	R/W	0	Reserved	
VBISL0_SYS625I _INV	6	R/W	0	Inverse the value of Sys625 Indication from VBI Decoder 1'b1 : Inverse the Field Value. 1'b0 : Normal Mode	
VBISL0_FIELDI NV	5	R/W	0	Inverse the value of field Indication from VBI Decoder 1'b1 : Inverse the Field Value. 1'b0 : Normal Mode	
VBISL0_IIR_IN_S EL	4	R/W	0	IIR_IN_SEL: Select the input data of DC IIR from ADC or fir raw data 1'b1 : Raw Data after FIR Filter 1'b0 : Raw Data	
VBISL0_DEBOU NCE_MODE_SEL	3	R/W	0	DEBOUNCE_MODE_SEL: de-bounce selection. 0: select consecutive 1's or 0's to de-bounce, which the length depends on CC/WSS_DEBOUNCE_SEL. 1: select voting approach to de-bounce, which the length depends on CC/WSS_VOTING_LENGTH.	

VBISL0_CLKRUNIN_DET_DIS	2	R/W	0	CLKRUNIN_DET_DIS: when ADAP_SLVL_EN set 1, select the frame code detection position by auto mode or manual control of VBI_CC_FRAME_START. For CC mode, this bit should be set 0 For WSS, this bit should be set 1. 0: Enable CC Clock Run-in Detection 1: Manual Setting Mode	
VBISL0_ADAP_SLVL_EN	1	R/W	1	ADAP_SLVL_EN: enable the adaptive slicer. When it is enable, the slicer level is determined by the built in adaptive slicer generator. When it is disable, the slicer level is specified in the BI_DATA_HLVL register. 0: off 1: on	
VBISL0_EN	0	R/W	0	VBI_EN: enable the VBI decoder. 0: off 1: on	

Register::VBISL2_2 0xC2					
Name	Bits	Read/Write	Reset State	Comments	config
VBISL2_HCNTNU_RST	7:0	R/W	0x1e	This register specifies the horizontal number of VBI EQ Reset. Because the data latency of VBI EQ, EQ can not use hsynci to reset VBI EQ. When H counter equals VBISL2_HCNTNU_RST, VBI Slicer will do something that listed below. Clear EQ coefficient (Only in TT) Clear CC/WSS Data Valid Signal Latch CC/WSS Output Length	

Register::VBISL2_1 0xC3					
Name	Bits	Read/Write	Reset State	Comments	config
Reserved	7:3	R/W	0	Reserved	
VBISL2_LCNT_FIELD_INV	2	R/W	0	This register is used to inverse the field signal for V/H Line counter in YpbPr Mode. 1'b0 : Normal Mode 1'b1 : Inverse Mode	
VBISL2_FREERUN_SAMPO	1:0	R/W	0x3	Specify the clock recovery counter clear mode of VBI 2'b00 : Clear clock recovery counter when VBI Bit Data translation (High go low or Low go high) 2'b01 : Clear clock recovery counter when VBI Bit Data translation only in Clock-runin & framing period. (High go low or Low go high) 2'b11 : Clear clock recovery counter when VBI Bit Data translation only in Clock-runin. (High go low or Low go high)	

Register::VBISL2_0					0xC4
Name	Bits	Read/Write	Reset State	Comments	config
VBISL2_MCFG_B	7:4	R/W	0x1	.Specify the VBI mode of active line of Bottom Field to detect. CC & WSS does not exist in active line simultaneously. 4'h1 : CC Mode 4'hC: WSS Mode Others : Disable VBI Detection Mode	
VBISL2_MCFG_T	3:0	R/W	0x1	.Specify the VBI mode of active line of Top Field to detect. CC & WSS does not exist in active line simultaneously. 4'h1 : CC Detection Mode 4'hC: WSS Detection Mode Others : Disable VBI Detection Mode	

Register::VBISL3_3					0xC5
Name	Bits	Read/Write	Reset State	Comments	config
Reserved	7:2	R/W	0	Reserved	
VBISL3_ALINE_B_MSB	1:0	R/W	0x1	Specify the active line of Bottom Field to detect CC or WSS. CC & WSS does not exist in active line simultaneously. Normally : CC exists in line 21 & 284. WSS exist in line 23 Line Number Include Line offset. For NTSC system, line offset is 6. For PAL/SECAM system, line offset is 3.	

Register::VBISL3_2					0xC6
Name	Bits	Read/Write	Reset State	Comments	config
VBISL3_ALINE_B_LSB	7:0	R/W	0x16	Specify the active line of Bottom Field to detect CC or WSS. CC & WSS does not exist in active line simultaneously. Normally : CC exists in line 21 & 284. WSS exist in line 23 Line Number Include Line offset. For NTSC system, line offset is 6. For PAL/SECAM system, line offset is 3.	

Register::VBISL3_1					0xC7
Name	Bits	Read/Write	Reset State	Comments	config
Reserved	7:2	R/W	0	Reserved	
VBISL3_ALINE_T_MSB	1:0	R/W	0	Specify the active line of Top Field to detect CC or WSS. CC & WSS does not exist in active line simultaneously. Normally : CC exists in line 21 & 284. WSS exist in line 23 Line Number Include Line offset. For NTSC system, line offset is 6. For PAL/SECAM system, line offset is 3.	

Register::VBISL3_0						0xC8					
Name	Bits	Read/Write	Reset State	Comments	config						
VBISL3_ALINE_T_LSB	7:0	R/W	0x0f	Specify the active line of Top Field to detect CC or WSS. CC & WSS does not exist in active line simultaneously. Normally : CC exists in line 21 & 284. WSS exist in line 23 Line Number Include Line offset. For NTSC system, line offset is 6. For PAL/SECAM system, line offset is 3.							

Register::VBISL6_3						0xC9					
Name	Bits	Read/Write	Reset State	Comments	config						
VBISL7_WSS625_DTO_MSB	7:0	R/W	0x15	WSS625_DTO: the 16-bit DTO incremental value for wss625 clock recovery circuit.							

Register::VBISL6_2						0xCA					
Name	Bits	Read/Write	Reset State	Comments	config						
VBISL7_WSS625_DTO_LSB	7:0	R/W	0x9a	WSS625_DTO: the 16-bit DTO incremental value for wss625 clock recovery circuit.							

Register::VBISL6_1						0xCB					
Name	Bits	Read/Write	Reset State	Comments	config						
VBISL6_CAPTION_DTO_MSB	7:0	R/W	0x35	CAPTION_DTO: the 16-bit DTO incrementer value for close caption clock recovery circuit.							

Register::VBISL6_0						0xCC					
Name	Bits	Read/Write	Reset State	Comments	config						
VBISL6_CAPTION_DTO_LSB	7:0	R/W	0x9F	CAPTION_DTO: the 16-bit DTO incrementer value for close caption clock recovery circuit.							

Register::VBISL8_3						0xCD					
Name	Bits	Read/Write	Reset State	Comments	config						
VBISL9_WSS_FRAME_START	7:0	R/W	0x64	WSS625_FRAME_START: The value of pixel count for VBI Slicer start to detect the framing code of WSS.							

Register::VBISL8_2						0xCE					
Name	Bits	Read/Write	Reset State	Comments	config						
VBISL9_CC_FRAME_START	7:0	R/W	0x64	CC_FRAME_START: The value of pixel count for VBI Slicer start to detect the framing code of closed caption.							

Register::VBISL8_1					0xCF	
Name	Bits	Read/Write	Reset State	Comments	config	
VBISL8_WSS_START	7:0	R/W	0x5a	WSS625_START: The value of pixel count for VBI Slicer start to detect the framing code of WSS.		

Register::VBISL8_0					0xD0	
Name	Bits	Read/Write	Reset State	Comments	config	
VBISL8_CC_START	7:0	R/W	0x5a	CC_START: The value of pixel count for VBI Slicer start to detect the framing code of closed caption.		

Register::VBISL10_2					0xD1	
Name	Bits	Read/Write	Reset State	Comments	config	
VBISL10_CC_PERIOD_MIN_CYC	7:0	R/W	0x20	CC_PERIOD_MIN_CYC: If the period counter of per clock run-in of teletext is in the range between CC_PERIOD_MAX_CYC and CC_PERIOD_MIN_CYC, the valid clock run-in counter of received teletext add 1.		

Register::VBISL10_1					0xD2	
Name	Bits	Read/Write	Reset State	Comments	config	
VBISL10_CC_PERIOD_MAX_CYC	7:0	R/W	0x44	CC_PERIOD_MAX_CYC: If the period counter of per clock run-in of teletext is in the range between CC_PERIOD_MAX_CYC and CC_PERIOD_MIN_CYC, the valid clock run-in counter of received teletext add 1.		

Register::VBISL10_0					0xD3	
Name	Bits	Read/Write	Reset State	Comments	config	
VBISL10_CC_VOTING_SEL	7:6	R/W	0	CC_VOTING_SEL: length choice for cc voting decision. 00: 3 01: 5 10: 7 11: 9		
VBISL10_CC_DC_FIR_SEL	5:4	R/W	0x3	CC_DC_FIR_SEL: Selection FIR Mode for CC DC Detection 2'b00: 2 points average of FIR. 2'b01: 4 points average of FIR. 2'b10: 8 points average of FIR. 2'b11: 16 points average of FIR others: 4 points average of FIR.		
VBISL10_CC_DC_IIR_SEL	3:2	R/W	0x2	CC_DC_IIR_SEL: Selection IIR Mode for CC DC Detection (b/(1-axZ[-1])) 2'b00: a = 3/4;		

				2'b01: a = 7/8; 2'b10: a = 15/16; 2'b11: a = 31/32; others: a = 7/8;	
VBISL10_CC_RAW_FIR_SEL	1:0	R/W	0x2	CC_RAW_FIR_SEL: Selection the FIR Mode Selection for VBI Raw Data. 2'b00: 2 points average of FIR. 2'b01: 4 points average of FIR. 2'b10: 8 points average of FIR. others: 2 points average of FIR.for VBI Slicer start to detect the framing code of closed caption.	

Register::VBISL11_2 0xD4					
Name	Bits	Read/Write	Reset State	Comments	config
Reserved	7:5	R/W	0	Reserved	
VBISL11_CC_FIR_ST_BIT_CYC	4:0	R/W	0x1f	CC_FIRST_BIT_CYC : The First Bit Cycle of CC. After latching correct DC value of CC, VBI Slicer start to count the cycles of "0" bits. If the cycle number of bit cycu counter above CC_FIRST_BIT_CYC, and VBI Slicer start to detect framing code.	

Register::VBISL11_1 0xD5					
Name	Bits	Read/Write	Reset State	Comments	config
Reserved	7:3	R/W	0	Reserved	
VBISL11_CC_DEBOUNCE_SEL	2:0	R/W	0x7	CC_DEBOUNCE_SEL: Select the mode of debounce mechanism of Teletext Data. 3'h0: No De-bounce, '0' => 0; '1' => 1; 3'h1: De-bounce 2T, '00' => 0; '11'=> 1; 3'h2: De-bounce 3T, '000' => 0; '111' => 1; 3'h3: De-bounce 4T, '0000' => 0; '1111' => 1; 3'h7: De-bounce 8T, '0000_0000'=>0; '1111_1111'=>1;	

Register::VBISL11_0 0xD6					
Name	Bits	Read/Write	Reset State	Comments	config
Reserved	7:4	R/W	0	Reserved	
VBISL11_CC_VALID_CLKRUNIN_NU	3:0	R/W	0x3	CC_VALID_CLKRUNIN_NU: The valid continuing clock run-in counter of teletext is larger or equal to CC_VALID_CLKRUNIN_NU, VBI Slicer start to calculate the DC value of teletext.	

Register::VBISL14_1 0xD7					
Name	Bits	Read/Write	Reset State	Comments	config

VBISL14_WSS_BP_DC_BASE	7:0	R/W	0x14	WSS_BP_DC_BASE: If the value of IIR is large than the sum of BP_DC and BP_DC_BASE, VBI slicer start to calculate valid clock run-in number of VBI signal.	
------------------------	-----	-----	------	---	--

Register::VBISL14_0 0xD8					
Name	Bits	Read/Write	Reset State	Comments	config
Reserved	7:6	R/W	0	Reserved	
VBISL14_WSS_DC_FIR_SEL	5:4	R/W	0x3	WSS_DC_FIR_SEL: Selection FIR Mode for CC DC Detection 2'b00 : The 2 points average of FIR. 2'b01 : The 4 points average of FIR. 2'b10 : The 8 points average of FIR. 2'b11 : The 16 points average of FIR others: The 4 points average of FIR.	
VBISL14_WSS_DC_IIR_SEL	3:2	R/W	0x2	WSS_DC_IIR_SEL: Selection IIR Mode for CC DC Detection ($b/(1-axZ[-1])$) 2'b00 : a = 3/4; 2'b01 : a = 7/8; 2'b10 : a = 15/16; 2'b11 : a = 31/32; others : a = 7/8;	
VBISL14_WSS_RAW_FIR_SEL	1:0	R/W	0x2	WSS_RAW_FIR_SEL: Selection the FIR Mode Selection for VBI Raw Data. 2'b00 : The 2 points average of FIR. 2'b01 : The 4 points average of FIR. 2'b10 : The 8 points average of FIR. others: The 2 points average of FIR.	

Register::VBISL15_2 0xD9					
Name	Bits	Read/Write	Reset State	Comments	config
Reserved	7:5	R/W	0	Reserved	
VBISL15_WSS_VOTING_SEL	4:3	R/W	0x3	WSS_VOTING_LENGTH: length choice for WSS voting decision. 00: 3 01: 5 10: 7 11: 9	
VBISL15_WSS_DEBOUNCE_SEL	2:0	R/W	0x7	WSS_DEBOUNCE_SEL: Select the mode of de-bounce mechanism of Teletext Data. 3'h0: No De-bounce, '0' => 0; '1' => 1; 3'h1: De-bounce 2T, '00' => 0; '11' => 1; 3'h2: De-bounce 3T, '000' => 0; '111' => 1; 3'h3: De-bounce 4T, '0000' => 0; '1111' => 1; 3'h7: De-bounce 8T, '0000_0000' => 0; '1111_1111' => 1;	

Register::VBISL15_1 0xDA					
Name	Bits	Read/Write	Reset State	Comments	config
VBISL15_WSS_STABLE_DC_NU	7:0	R/W	0x14	WSS_STABLE_DC_NU: The stable dc counter of teletext is larger or equal to WSS_STABLE_DC_NU, VBI Slicer start to calculate the DC value of teletext.	

Register::VBISL15_0 0xDB					
Name	Bits	Read/Write	Reset State	Comments	config
VBISL15_WSS_STABLE_DC_LOW_THD	7:0	R/W	0x2	WSS_STABLE_LOW_THD: The low threshold of stable dc detection.	

Register::VBISL16_0 0xDC					
Name	Bits	Read/Write	Reset State	Comments	config
Reserved	7:3	R/W	0	Reserved	
VBISL16_CGMS_INT_EN	2	R/W	0	Enable the interrupt function of CGMS 1'b1 : Enable. 1'b0 : Disable.	
VBISL16_WSS_INT_EN	1	R/W	0	Enable the interrupt function of WSS 1'b1 : Enable. 1'b0 : Disable.	
VBISL16_CC_INT_EN	0	R/W	0	Enable the interrupt function of CC 1'b1 : Enable. 1'b0 : Disable.	

Register::VBISL161_1 0xDD					
Name	Bits	Read/Write	Reset State	Comments	config
VBISL16_CC_RUNIN_PERIOD	7:0	R	0	Latch the clock runin period when Clock run-in is valid	

Register::VBISL161_0 0xDE					
Name	Bits	Read/Write	Reset State	Comments	config
Reserved	7	R/W	0	Reserved	
CGMS_C4_CGMS_VLD_CLR	6	R/W	0	Write "1" to clear CGMS_C4_CGMS_VLD	
VBISL16_WSS_RDY_CLR	5	R/W	0	Write "1" to clear BSL16_WSS_RDY	
VBISL16_CC_RDY_CLR	4	R/W	0	Write "1" to clear VBISL16_CC_RDY	
CGMS_C4_CGMS_VLD	3	R	0	CGMS DATA_Valid Indicator (Event Mode) 1: Valid. 0: Non-valid.	
VBISL16_CC_FIELD	2	R	0	CC Field Indication: 0 : Top Field 1 : Bottom Field	

VBISL16_WSS_RDY	1	R	0	WSS_RDY: The received data ready indicator for WSS. (write "1" to clear)	
VBISL16_CC_RDY	0	R	0	CC_RDY: The received data ready indicator for CC. (write "1" to clear)	

Register::VBISL17_1 0xDF					
Name	Bits	Read/Write	Reset State	Comments	config
VBISL17_CC_DATA1o	7:0	R	0	CC_DATA1o: The 2th byte of CC.	

Register::VBISL17_0 0xE0					
Name	Bits	Read/Write	Reset State	Comments	config
VBISL17_CC_DATA0o	7:0	R	0	CC_DATA0o: The 1th byte of CC.	

Register::VBISL171_1 0xE1					
Name	Bits	Read/Write	Reset State	Comments	config
VBISL17_WSS_DATA1o	7:0	R	0	WSS_DATA1o: The 2th byte of WSS.	

Register::VBISL171_0 0xE2					
Name	Bits	Read/Write	Reset State	Comments	config
VBISL17_WSS_DATA0o	7:0	R	0	WSS_DATA0o: The 1th byte of WSS.	

Register::CGMS_C0_3 0xE3					
Name	Bits	Read/Write	Reset State	Comments	config
Reserved	7:3	R/W	00	reserved	
CGMS_C0_DEBOUNCE_SEL	2:0	R/W	0x7	Debounce Mode Selection 3'h0 : No-debounce. 3'h1 : 2T Debounce ... 3'h7: 8T Debounce	

Register::CGMS_C0_2 0xE4					
Name	Bits	Read/Write	Reset State	Comments	config
Reserved	7:2	R/W	0	reserved	
CGMS_C0_SLICER_DCL_MSB	1:0	R/W	1	Manual Slicer DC level Setting	

Register::CGMS_C0_1 0xE5					
Name	Bits	Read/Write	Reset State	Comments	config
CGMS_C0_SLICER_DCL_LSB	7:0	R/W	00	Manual Slicer DC level Setting	

Register::CGMS_C0_0 0xE6					
Name	Bits	Read/Write	Reset	Comments	config

			State	
Reserved	7:6	R/W	0	reserved
CGMS_C0_LPF_SEL	5:4	R/W	1	CGMS LPF Filter Selection: 00 : 4 points average 01 : 8 points average 10 : 16 points average others : 8 points average
CGMS_C0_SLICER_MS	3:2	R/W	00	Slicer mode select 00 : 525 i 01 : 525p 10 : 720p 11 : 1080i
CGMS_C0_ADAP_SLVL_EN	1	R/W	1	When it is enable, the slicer DC level is determined by the built in adaptive slicer generator. When it is disable, the slicer level is specified in SLIC_DCL 0: off 1: on
CGMS_C0_SLICER_N	0	R/W	0	enable the CGMS slicer. 0: off 1: on

Register::CGMS_C1_3 0xE7					
Name	Bits	Read/Write	Reset State	Comments	config
Reserved	7:2	R/W	00	reserved	
CGMS_C1_ACTL_INE_T_MSB	1:0	R/W	0	Active CGMS Line for TOP Field. For 525i, 525p, 720p, 1080i	

Register::CGMS_C1_2 0xE8					
Name	Bits	Read/Write	Reset State	Comments	config
CGMS_C1_ACTL_INE_T_LSB	7:0	R/W	0x0e	Active CGMS Line for TOP Field. For 525i, 525p, 720p, 1080i	

Register::CGMS_C1_1 0xE9					
Name	Bits	Read/Write	Reset State	Comments	config
Reserved	7:2	R/W	00	reserved	
CGMS_C1_ACTL_INE_B_MSB	1:0	R/W	1	Active CGMS Line for Bottom Field. For 525i, 1080i	

Register::CGMS_C1_0 0xEA					
Name	Bits	Read/Write	Reset State	Comments	config
CGMS_C1_ACTL_INE_B_LSB	7:0	R/W	0x15	Active CGMS Line for Bottom Field. For 525i, 1080i	

Register::CGMS_C2_3 0xEB					
Name	Bits	Read/Write	Reset State	Comments	config
Reserved	7:2	R/W	00	reserved	
CGMS_C2_DCDE_T_ST_MSB	1:0	R/W	0	Time delay from h_sync trailing edge to the time when slicer start to calculate DC level	

Register::CGMS_C2_2 0xEC					
Name	Bits	Read/Write	Reset State	Comments	config
CGMS_C2_DCDE T_ST_LSB	7:0	R/W	0x64	Time delay from h_sync trailing edge to the time when slicer start to calculate DC level	

Register::CGMS_C2_1 0xED					
Name	Bits	Read/Write	Reset State	Comments	config
Reserved	7:2	R/W	00	reserved	
CGMS_C2_DCDE T_END_MSB	1:0	R/W	1	Time delay from h_sync trailing edge to the time when slicer end to calculate DC level	

Register::CGMS_C2_0 0xEE					
Name	Bits	Read/Write	Reset State	Comments	config
CGMS_C2_DCDE T_END_LSB	7:0	R/W	0x90	Time delay from h_sync trailing edge to the time when slicer end to calculate DC level	

Register::CGMS_C3_1 0xEF					
Name	Bits	Read/Write	Reset State	Comments	config
Reserved	7:2	R/W	00	reserved	
CGMS_C3_LV_D C_TH_MSB	1:0	R/W	0	The minimum DC difference between high and low level to judge if the CGMS Line is valid	

Register::CGMS_C3_0 0xF0					
Name	Bits	Read/Write	Reset State	Comments	config
CGMS_C3_LV_D C_TH_LSB	7:0	R/W	0x1e	The minimum DC difference between high and low level to judge if the CGMS Line is valid	

Register::CGMS_C4_2 0xF1					
Name	Bits	Read/Write	Reset State	Comments	config
Reserved	7:4	R/W	00	reserved	
CGMS_C4_CGMS DATA_MSB	3:0	R	00	CGMS_DATA_OUT[19:0], The sequence is word0[19:18], word1[17:14],word2[13:6],CRCC[5:0].	

Register::CGMS_C4_1 0xF2					
Name	Bits	Read/Write	Reset State	Comments	config
CGMS_C4_CGMS DATA_LSB1	7:0	R	00	CGMS_DATA_OUT[19:0], The sequence is word0[19:18], word1[17:14],word2[13:6],CRCC[5:0].	

Register::CGMS_C4_0 0xF3					
Name	Bits	Read/Write	Reset State	Comments	config
CGMS_C4_CGMS	7:0	R	00	CGMS_DATA_OUT[19:0],	

DATA_LSB0				The sequence is word0[19:18], word1[17:14],word2[13:6],CRCC[5:0].	
-----------	--	--	--	---	--

Register::CGMS_C5_2 0xF4					
Name	Bits	Read/Write	Reset State	Comments	config
CGMS_C5_Min_period	7:0	R/W	0x38	Check the min period of first bit	

Register::CGMS_C5_1 0xF5					
Name	Bits	Read/Write	Reset State	Comments	config
CGMS_C5_Max_period	7:0	R/W	0x40	Check the mam period of first bit	

Register::CGMS_C5_0 0xF6					
Name	Bits	Read/Write	Reset State	Comments	config
CGMS_C5_period	7:0	R/W	0x3b	Specify the CGMS bit period to sample the CGMS data.	

Register::ADDC0_0 0xF7					
Name	Bits	Read/Write	Reset State	Comments	config
Reserved	7:4	R/W	0	reserved	
ADDC0_BIT_ARB	3	R/W	1	4 points average of FIR 1'b0 : Disable ◦ 1'b1 : Enable ◦	
ADDC0_DC_AVG_SEL	2:1	R/W	00	Select the clock cycle period to calculate Teletext DC value, this register is actived only for Teletext. 2'b00 : 8 Clock Cycles 2'b01 : 16 Clock Cycles 2'b10 : 32 Clock Cycles. 2'b11 : 64 Clock Cycles.	
ADDC0_EN	0	R/W	0	Enable the auto adaptive dc calculation mechanism which detect the max and min value of VBI raw data in fixed period to calculate the DC value ◦ 1'b1 : Enable ◦ 1'b0 : Disable ◦	

Register::ADDC1_0 0xF8					
Name	Bits	Read/Write	Reset State	Comments	config
ADDC1_DC_CC_FIR_SEL	7:6	R/W	0x3	In ADDC mode, this register is used to select the Closed Caption Raw Data Filter mode which to filter the Closed Caption Raw data. After filter, Closed Caption filter data is used to calculate Closed Caption DC value. 2'b11 : Average 8 Filter. 2'b10 : Average 4 Filter. 2'b01 : Average 2 Filter. 2'b00 : Original Closed Caption Raw	

				Data.	
ADDC1_DC_WSS_FIR_SEL	5:4	R/W	0x3	In ADDC mode, this register is used to select the WSS Raw Data Filter mode which to filter the WSS Raw data. After filter, WSS filter data is used to calculate WSS DC value. 2'b11 : Average 8 Filter. 2'b10 : Average 4 Filter. 2'b01 : Average 2 Filter. 2'b00 : Original WSS Raw Data.	
ADDC1_CC_FIR_SEL	3:2	R/W	0x3	In ADDC mode, this register is used to select the Closed Caption Raw Data Filter mode which to filter the Closed Caption Raw data. After filter, Closed Caption filter data is used to compare with Closed Caption DC value and gets Closed Caption Sliced bit data. 2'b11 : Average 8 Filter. 2'b10 : Average 4 Filter. 2'b01 : Average 2 Filter. 2'b00 : Original Closed Caption Raw Data.	
ADDC1_WSS_FIR_SEL	1:0	R/W	0x3	In ADDC mode, this register is used to select the WSS Raw Data Filter mode which to filter the WSS Raw data. After filter, WSS filter data is used to compare with WSS DC value and gets WSS Sliced bit data. 2'b11 : Average 8 Filter. 2'b10 : Average 4 Filter. 2'b01 : Average 2 Filter. 2'b00 : Original WSS Raw Data.	

Register::ADDC2_1 0xF9					
Name	Bits	Read/Write	Reset State	Comments	config
ADDC2_DC_TH2	7:0	R/W	0x78	In ADDC mode, the register is used to detect the max and min data valid in fixed period. If the difference of max and min VBI data larger than DC Threshold 1, the value of VBI DC will be updated. In CC Mode, DC_TH1 only be used before framing code hit. After framing code hit, the DC threshold will be changed to DC threshold 2. In TT, VPS & WSS mode, this DC threshold will be used all detection period.	

Register::ADDC2_0 0xFA					
Name	Bits	Read/Write	Reset State	Comments	config
ADDC2_DC_TH1	7:0	R/W	0xa0	In ADDC mode, the register is used to detect the max and min data valid in fixed period.	

				If the difference of max and min VBI data larger than DC Threshold 1, the value of VBI DC will be updated. In CC Mode, DC_TH1 only be used before framing code hit. After framing code hit, the DC threshold will be changed to DC threshold 2. In TT, VPS & WSS mode, this DC threshold will be used all detection period.	
--	--	--	--	---	--

Register::ADDC3_3					0xFB
Name	Bits	Read/Write	Reset State	Comments	config
Reserved	7:2	R/W	0	reserved	
REG_ADDC3_MIN_MSB	1:0	R	0	Max value of VBI Data in detection period	

Register::ADDC3_2					0xFC
Name	Bits	Read/Write	Reset State	Comments	config
REG_ADDC3_MIN_LSB	7:0	R	0	Max value of VBI Data in detection period	

Register::ADDC3_1					0xFD
Name	Bits	Read/Write	Reset State	Comments	config
RESERVED	7:2	R/W	0	Reserved	
REG_ADDC3_MAX_MSB	1:0	R	0	Min value of VBI Data in detection period	

Register::ADDC3_0					0xFE
Name	Bits	Read/Write	Reset State	Comments	config
REG_ADDC3_MAX_LSB	7:0	R	0	Min value of VBI Data in detection period	

Address: 0xFF Reserved

Video Color Space Conversion

Address: 9C YUV_RGB_CTRL (YUV <-> RGB Control Register) Default: 10h

Bit	Mode	Function
7:5	---	Reserved
4	R/W	Color Conversion Type 0: YUV->RGB 1: RGB->YUV (U,V are translated to unsigned 8-bit number)
3	R/W	Enable YUV/RGB coefficient Access: 0: Disable 1: Enable If this bit is set to 0, the address of the data port will reset to 0, and continuously writes 18 bytes

2	R/W	Cb Cr Clamp 0: Bypass 1: Cb-128, Cr-128 (MSB Inversion)
1	R/W	Y Gain/Offset: 0 : Bypass 1: (Y-16)*1.164
0	R/W	Enable YUV <-> RGB Conversion: 0: Disable YUV<->RGB conversion (Default) 1: Enable YUV<->RGB conversion

Address: 9D **YUV_RGB_COEF_DATA**

Bit	Mode	Function
7:0	W	COEF_DATA[7:0]

Paged Control Register

Address: 9F **PAGE_SEL** **Default: 00h**

Bit	Mode	Function
7:4	R/W	Reserved to 0
3:0	R/W	Page Selector (CRA0~CRFF) Page 0: Embedded ADC/ABL/LVR/Smith trigger Page 1: PLL Page 2: Reserved Page 3: Reserved Page 4: Reserved Page 5: Reserved Page 6: Deinterlace/Noise reduction/Scaling down Page 7: vidvid color/DCC/ICM Page 8~PageA: VD Page B: Off line sync processor Page D~PageF:MCU Others: reserved

Embedded ADC (Page 0)
Embedded VADC

Register::SOY comparator select					0XA0
Name	Bit	R/W	Default	Description	Config
ADC_SOYIS1<1:0>	7:6	R/W	00	SOY Comparator1 input select (OFF line) 00: VIN0P 01: VIN1P 10: VIN2P 11: VIN3P	
Rev	5:4	---	---	Reserved	
ADC_BUFO_SW<1:0>	3:2	R/W	00	Buffer out switch(A/V out selector) 00: Vin0 to 11: Vin3	
REG_ADC_SOY_CALI	1	R/W	0	SOG1 ADC&DAC Calibration (0: Normal 1: Calibration)	
Rev	0	---	---	Reserved	

Register::ADC CTRL					0XA1
Name	Bit	R/W	Default	Description	Config
Rev	7	---	---	Reserved	
ADC_ADCGC	6	R/W	0	ADC gain calibration(when YPrPb mode) 0: normal 1:calibration	
ADC_ADC1_IS	5	R/W	0	ADC1 Video Input Select 0: Video Input1 1: Video Input3	
ADC_ADC0_IS	4	R/W	0	ADC0 Video Input Select 0: Video Input10: Video Input2	
ADC_IM<3:0>	3:0	R/W	F	VIN<3:0>N Negative Input Mode Selection 0: Singel Ended 1: Differential	

Register::ADC CLOCK SOURCE					0XA2
Name	Bit	R/W	Default	Description	Config
Rev	7	---	---	Reserved	
ADC_ADC1FTD<2:	6:4	R/W	0	ADC1 input clock fine tune delay	

0>				000: 0ps to 111: 630ps Step: 90ps	
Rev	3	---	---	Reserved	
ADC_ADC0FTD<2: 0>	2:0	R/W	0	ADC0 input clock fine tune delay 000: 0ps to 111: 630ps Step: 90ps	

Register::ADC OUTPUT DELAY CTRL					0XA3
Name	Bit	R/W	Default	Description	Config
ADC_COD<1:0>	7:6	R/W	0	ADC Clock Output Divider 00:1/1 01:1/2 10:1/3 11:1/4	
ADC_ADCOPED<1: 0>	5:4	R/W	0	ADC output pixel extra delay 00:1n 01:1.2n 10:1.4n 11:1.6n	
Rev	3	---	---	Reserved	
ADC_SOYCLKP	2	R/W	0	SOY1,0_ADC output data polarity 0: positive 1: negative	
ADC_ADCICLKP	1	R/W	0	ADC input clock polarity 0: positive 1: negative	
ADC_ADCOCLKP	0	R/W	0	ADC1,0 output clock polarity 0: positive 1: negative	

Address 0xA4 is reserved

Register::ADC input BW					0XA5
Name	Bit	R/W	Default	Description	Config
ADC_REG_VCM_V 33	7	R/W	1	VCM mode 0: current	

				1: voltage	
ADC_TOS<2:0>	6:4	R/W	0	Test Output Selection, at PIN VIN2N(ADC0), VIN3N(ADC1) 000:X(Hi-Z) Normal SOG Mode 001:VRB 010:vrbb 011:vcm_cmp 100:vrtt 101:VMIDI 110:VOFFSET 111:VRT	
ADC_VCM_DEC_I <1:0>	3:2	R/W	01	VCM 00: 1.64V 01: 1.65V 10: 1.66V 11: 1.67V	
ADC_VCM_DEC_V <1:0>	1:0	R/W	10	Set when VDD= 00: 3.2V 01: 3.4V 10: 3.3V 11: 3.0V	

Register::ADC1 input pga					0XA6
Name	Bit	R/W	Default	Description	Config
ADC_ADC1_BA<1: 0>	7:6	R/W	10	ADC1 input bandwidth adjustment 00: 10MHz 01: 25MHz 10: 75MHz 11: 200MHz	
ADC_ADC1_PGA< 2:0>	5:3	R/W	100	ADC1 PGA gain adjust 000: 1 001: 1.3 010: 1.76 011: 2 100: 2.3 101: 2.7	

				110: 3.27 111: 4.16	
ADC_ADC1_CV<2: 0>	2:0	R/W	100	ADC1 channel clamp voltage 000: 0mV to 111: 700mV Step: 100mV	

Register::ADC0 input PGA 0XA7					
Name	Bit	R/W	Default	Description	Config
ADC_ADC0_BA<1: 0>	7:6	R/W	10	ADC0 input bandwidth adjustment 00: 10MHz 01: 25MHz 10: 75MHz 11: 200MHz	
ADC_ADC0_PGA< 2:0>	5:3	R/W	100	ADC0 PGA gain adjust 000: 1 001: 1.3 010: 1.76 011: 2 100: 2.3 101: 2.7 110: 3.27 111: 4.16	
ADC_ADC0_CV<2: 0>	2:0	R/W	100	ADC0 channel clamp voltage 000: 0mV to 111: 700mV Step: 100mV	

Register::VADC CLAMP 0XA8					
Name	Bit	R/W	Default	Description	Config
Rev	7:5	---	---	Reserved	
ADC_OFFLINE_SR C	4	R/W	1	OFFLINE clamp source(SOY1) 0: 100mV 1: 400mV	
ADC_ADC1_CMS< 1:0>	3:2	R/W	0	ADC1 channel clamp mode selection 00: clamp to black- Low clamp 01: clamp to black-Middle clamp 10: clamp to sync	

				11: clamp to top	
ADC_ADC0_CMS<1:0>	1:0	R/W	0	ADC0 channel clamp mode selection 00: clamp to black- Low clamp 01: clamp to black-Middle clamp 10: clamp to sync 11: clamp to top	

Register::ADC inrange CTRL					0XA9
Name	Bit	R/W	Default	Description	Config
ADC_INRANGE<1:0>	7:6	R/W	11	ADC1,0 Vmid, Voffset Voltage Adjust 0: Vmid=0V/0.75V/1.5V, Voffset=0.75V 1: Vmid=0V/0.5V/1.0V, Voffset=0.5V	
Rev	---	---	---	Reserved	
ADC_VDC_CLAMP_SP<4:0>	4:0	R/W	1	VDC clamping current control I=20uA*sp<3:0>+10uA, shunt ohm if sp<4> is 1	

Address 0xAA are reserved

Register::ADC1 SOY BIAS CURRENT					0XAB
Name	Bit	R/W	Default	Description	Config
Rev	7:6	---	---	Reserved	
ADC_SOYBIAS1<1:0>	5:4	R/W	1	Bias Current of SOY_6bitADC1 S/H 00:15u 01:20u 10:25u 11:30u	
ADC_SRCBIAS<3:0>	3:0	R/W	0X08	ADC<1:0> Mbias (MDAC+Buffer) source current select 0000=20u, 0001=22.5u, 0010=25u, 0011=27.5u 0100=30u, 0101=32.5u, 0110=35u, 0111=37.5u 1000=40u, 1001=42.5u, 1010=45u, 1011=47.5u 1100=50u, 1101=52.5u, 1110=55u, 1111=57.5u	

Register::ADC INPUT CHANNEL BIAS CURRENT					0XAC
Name	Bit	R/W	Default	Description	Config
ADC_CHBIAS<3:0>	7:4	R/W	0X08	VIN<3:0><P,N> Input Channel bias current select 0000=20u, 0001=22.5u, 0010=25u, 0011=27.5u 0100=30u, 0101=32.5u, 0110=35u, 0111=37.5u 1000=40u, 1001=42.5u, 1010=45u, 1011=47.5u 1100=50u, 1101=52.5u, 1110=55u, 1111=57.5u	
ADC_BIAS<3:0>	3:0	R/W	0X08	AFE_MBIAS/SOY bias current select 0000=20u, 0001=22.5u, 0010=25u, 0011=27.5u 0100=30u, 0101=32.5u, 0110=35u, 0111=37.5u 1000=40u, 1001=42.5u, 1010=45u, 1011=47.5u 1100=50u, 1101=52.5u, 1110=55u, 1111=57.5u	

Register::Positive Input SOY Restore Resistor					0XAD
Name	Bit	R/W	Default	Description	Config
ADC_SOYDCR_EN<3:0>	7:4	R/W	0	Vin3(bit3) to Vin0(bit0)SOY DC restore enable	
ADC_SOYR<3:0>	3:0	R/W	0	VIN<3:0>P Positive Input SOY DC Restore Resistor 0: Poly R=500K,external C=10n 1: MOS R=1M,external C=4.7n	

Register:: ADC POW					0XAE
Name	Bit	R/W	Default	Description	Config
ADC_YPP_POW<3:	7:4	R/W	0	YPbPr clamp 3..0 power on	

0>				0: power down 1: power on	
ADC_VDC_POW<3:0>	3:0	R/W	0	VDC clamp 3..0 power on	
0>				0: power down 1: power on	

Register::VADC/Video-8 switch					0XAF
Name	Bit	R/W	Default	Description	Config
REV	7	---	---	Reserved	
ADC_PADEN	6	R/W	0	REG_ADC_PADEN VADC/Video8 Switch (0: VADC 1:Video8)	
ADC_BUFOPOW	5	R/W	0	Buffer out power on(AV out enable) 0: power down 1: power on	
ADC_SOYCLPOW<1:0>	4:3	R/W	0	SOY Compare<1:0> power on 0: power down 1: power on	
ADC_ADCPOW<1:0>	2:1	R/W	0	ADC power on (ADC_ADCPOW[0] must be always high while video decoder is enabled, otherwise, the clock for video decoder will not be output) 0: power down 1: power on	
ADC_GLPOW	0	R/W	1	GLOBAL power on 0: power down 1: power on	

Address 0xB0~0xBF are reserved

Embedded YPP ADC

Register::red gain					0XC0
Name	Bit	R/W	Default	Description	Config
ADC_GAI_RED[7:0]	7:0	R/W	0x80	Red Channel Gain Adjust	

Register::green gain					0XC1
Name	Bit	R/W	Default	Description	Config
ADC_GAI_GRN[7:0]	7:0	R/W	0x80	Green Channel Gain Adjust	

Register::blue gain					0XC2
Name	Bit	R/W	Default	Description	Config
ADC_GAI_BLU[7:0]	7:0	R/W	0x80	Blue Channel Gain Adjust	

Register::RED OFFSET					0XC3
Name	Bit	R/W	Default	Description	Config
ADC_OFF_RED[7:0]	7:0	R/W	0x80	Red Channel Offset Adjust	

Register::GREEN OFFSET					0XC4
Name	Bit	R/W	Default	Description	Config
ADC_OFF_GRN[7:0]	7:0	R/W	0x80	Green Channel Offset Adjust	

Register::BLUE OFFSET					0XC5
Name	Bit	R/W	Default	Description	Config
ADC_OFF_BLU[7:0]	7:0	R/W	0x80	Blue Channel Offset Adjust	

Register:: ADC_POWER[7:0]					0XC6
Name	Bit	R/W	Default	Description	Config
ADC_POWER[7]	7	---	0	Reserved	
ADC_POWER[6]	6	R/W	0	2nd ADC/Video Switch (0: AHS1/AVS1 1:Video8)	
ADC_POWER[5]	5	R/W	0b0	SOG_ADC0 Power On (0: Power Down 1: Power On)	
ADC_POWER[4]	4	R/W	0b0	SOG_ADC1 Power On (0: Power Down 1: Power On)	
ADC_POWER[3]	3	R/W	0b1	Bandgap Power On (0: Power Down 1: Power On)	
ADC_POWER[2]	2	R/W	0b0	Red Channel ADC Power On (0: Power Down 1: Power On)	
ADC_POWER[1]	1	R/W	0b0	Green Channel ADC Power On (0: Power Down 1: Power On)	

ADC_POWER[0]	0	R/W	0b0	Blue Channel ADC Power On (0: Power Down 1: Power On)	
--------------	---	-----	-----	---	--

Register:: ADC_IBIAS0[7:0]					0XC7
Name	Bit	R/W	Default	Description	Config
ADC_IBIAS0[7:6]	7:6	R/W	0b01	Bias Current of M2PLL_IB20U (00:16u 01:20u 10:24u 11:28u) Bias Current of DPLL_IB20U (00:16u 01:20u 10:24u 11:28u) Bias Current of AUDIOPLL_IB20U (00:16u 01:20u 10:24u 11:28u)	
ADC_IBIAS0[5:4]	5:4	R/W	0b01	Bias Current of HSYNC_IB60U (00:48u 01:60u 10:72u 11:84u) Adjust Hsync level	
ADC_IBIAS0[3:2]	3:2	R/W	0b01	Bias Current of LVDS_IB20U (00:16u 01:20u 10:24u 11:28u)	
ADC_IBIAS0[1]	1	R/W	0b0	Reserved	
ADC_IBIAS0[0]	0	R/W	0b1	SOG0 input MUX select, high bit	

Register:: ADC_IBIAS1[7:0]					0XC8
Name	Bit	R/W	Default	Description	Config
ADC_IBIAS1[7:6]	7:6	R/W	0b00	SOG0 input MUX select, low 2 bits (000: SOG1 001:B1 010:G1 011:R1 100: SOG0 101:B0 110:G0 111:R0)	
ADC_IBIAS1[5:4]	5:4	R/W	0b01	Bias Current of SOG_ADC_IB20U (00:15u 01:20u 10:25u 11:30u)	
ADC_IBIAS1[3:2]	3:2	R/W	0b01	Bias Current of CEC_IB10U (00:8u 01:10u 10:12u 11:14u)	
ADC_IBIAS1[1:0]	1:0	R/W	0b01	Bias Current of SARADC_IB20U (00:16u 01:20u 10:24u 11:28u)	

Register:: ADC_IBIAS2[7:0]					0XC9
Name	Bit	R/W	Default	Description	Config
ADC_IBIAS2[7:6]	7:6	R/W	0b01	Bias Current of APLL_IB60U (00:48u 01:60u 10:72u 11:84u)	

ADC_IBIAS2[5:4]	5:4	R/W	0b01	Bias Current of ADC_SF (00:15u 01:20u 10:25u 11:30u)
ADC_IBIAS2[3]	3	R/W	0b0	Bias Current of ADC_REF (0:60u 1:80u)
ADC_IBIAS2[2:0]	2:0	R/W	0b011	Bias Current of ADC_OP (000:10u 001:15u 010:17.5u 011:20u 100:22.5u 101:25u 110:27.5u 111:30u)

Register:: ADC_VBIAS0[7:0]					0XCA
Name	Bit	R/W	Default	Description	Config
ADC_VBIAS0[7]	7	R/W	0b0	Resistor Reference (0:Ref. To Internal R 1:Ref. To External R=2K, for FIB)	
ADC_VBIAS0[6:4]	6:4	R/W	0b010	Bandgap Voltage (000:0.890 001:0.841 010:0.792 011:0.742 100:0.693 101:0.644 110:0.594 111:545)	
ADC_VBIAS0[3:2]	3:2	R	---	Thermal Sensor (00:<30 01:30-60 10:60-90 11:>90)	
ADC_VBIAS0[1:0]	1:0	R/W	0b01	Bandgap Voltage (00:0.775 01:0.792 10:0.810 11:0.829)	

Register:: ADC_VBIAS1[7:0]					0XCB
Name	Bit	R/W	Default	Description	Config
ADC_VBIAS1[7]	7	R/W	0b0	ADC Gain Calibration (0: Normal 1: Calibration)	
ADC_VBIAS1[6]	6	R/W	0b0	ADC 2X OverSample (0:1x 1:2x)	
ADC_VBIAS1[5]	5	R/W	0b0	Output 1X Clock Polarity (0:Normal 1:Inverted)	
ADC_VBIAS1[4]	4	R/W	0b0	Output 2X Clock Polarity (0:Normal 1:Inverted)	
ADC_VBIAS1[3]	3	R/W	0b1	RGB Input Range Adjust 0: 0.3V-1.2V, 1: 0.5V-1.0V	
ADC_VBIAS1[2]	2	R/W	0b1	Vcmo from VBG or from VDD (0:from VBG 1:from VDD)	
ADC_VBIAS1[1:0]	1:0	R/W	0b01	Vcmo Voltage (00:0.90 01:1.00 1:1.05 11:1.10)	

Register:: ADC_CLOCK[7:0]					0XCC
Name	Bit	R/W	Default	Description	Config
ADC_CLOCK[7]	7	R/W	0b0	Input Clock Polarity (0:Negative 1:Positive)	
ADC_CLOCK[6]	6	R/W	0b0	Output Divider Clock Polarity (0:Normal 1:Inverted)	
ADC_CLOCK[5:4]	5:4	R/W	0b0	ADC_OUT_PIXEL Delay (00:1.05n 01:1.39n 10:1.69n 11:1.97n)	
ADC_CLOCK[3]	3	R/W	0b0	1X or 2X from APLL (0:1X 1:2X)	
ADC_CLOCK[2]	2	R/W	0b0	Single Ended or Diff. Clock from APLL (0:Diff. 1:Single Ended)	
ADC_CLOCK[1:0]	1:0	R/W	0b1	Duty Stabilizer	

Register:: ADC_TEST[7:0]					0XCD
Name	Bit	R/W	Default	Description	Config
ADC_TEST[7]	7	R/W	0b0	Clock Input (0: from APLL/3.3V 1: from TTL/1.8V)	
ADC_TEST[6:4]	6:4	R/W	0b000	Test Ouput Selection (PAD: SOGIN0, SOGIN1) SOGIN0 (000:X 001:gnd 010:vrbir 011:vcmi 100:vrtr 101:vmid 110:voffset 111:vdd) SOGIN1 (000:X 001:gnd 010:vreft 011:vcmo 100:vreft 101:gnd 110:gnd 111:vdd)	
ADC_TEST[3]	3	R/W	0b0	SOG1 ADC&DAC Calibration (0: Normal 1: Calibration)	
ADC_TEST[2]	2	R/W	0b0	SOG1 ADC output data pos/neg (0: pos 1:neg)	
ADC_TEST[1:0]	1:0	R/W	0b00	Clock Output Divider (00: 1/1 01: 1/2 10: 1/3 11: 1/4)	

Register:: ADC_CTL_RGB[7:0]					0XCE
Name	Bit	R/W	Default	Description	Config
ADC_CTL_RGB	7:6	R/W	0b01	PGA (00: Ash=0.9 01: Ash=1.0 10: 11: Ash=1.1)	

[7:6]				Ash=1.1 11: Ash=1.2)	
ADC_CTL_RGB [5:4]	5:4:	R/W	0b01	PGA (00: Aref=0.9 01: Aref=1.0 10: Aref=1.1 11: Aref=1.2)	
ADC_CTL_RGB [3]	3	R/W	0b0	Dual (0: Input0 1: Input1) (Need to Select the Corresponding ADC_OUT_SOG0/1)	
ADC_CTL_RGB [2]	2	R/W	0b1	Single Ended or Diff. Input (0: Single Ended 1: Diff)	
ADC_CTL_RGB [1:0]	1:0	R/W	0b10	Bandwidth (00: 75M 01: 150M 10: 300M 11: 500M)	

Register:: ADC_CTL_RED[7:0]					0XCF
Name	Bit	R/W	Default	Description	Config
ADC_CTL_RED [7]	7	R/W	0b0	Clamp Voltage Source Select (0: Input0: VONLINE, Input1: VOFFLINE 1: Input0: VOFFLINE, Input1: VONLINE)	
ADC_CTL_RED [6:4]	6:4	R/W	0b101	Clamp Voltage, VONLINE (0V~700mV, Step=100mV)	
ADC_CTL_RED [3]	3	R/W	0b0	Offset Depends on Gain (0: RGB Yes, YPrPb No 1:RGB No, YPrPb No)	
ADC_CTL_RED[2:0]	2:0	R/W	0b0	Red Channel ADC Fine Tune Delay, Step=90ps	

Register:: ADC_CTL_GRN[7:0]					0XD0
Name	Bit	R/W	Default	Description	Config
ADC_CTL_GRN [7]	7	R/W	0b0	Clamp Voltage Source Select (0: Input0: VONLINE, Input1: VOFFLINE 1: Input0: VOFFLINE, Input1: VONLINE)	
ADC_CTL_GRN [6:4]	6:4	R/W	0b101	Clamp Voltage, VONLINE (0V~700mV, Step=100mV)	
ADC_CTL_GRN	3	R/W	0b0	Offset Depends on Gain	

[3]				(0: RGB Yes, YPrPb No 1:RGB No, YPrPb No)	
ADC_CTL_GRN[2:0]	2:0	R/W	0b0	Green Channel ADC Fine Tune Delay, Step=90ps	

Register:: ADC_CTL_BLU[7:0]					0XD1
Name	Bit	R/W	Default	Description	Config
ADC_CTL_BLU[7]	7	R/W	0b0	Clamp Voltage Source Select (0: Input0: VONLINE, Input1: VOFFLINE 1: Input0: VOFFLINE, Input1: VONLINE)	
ADC_CTL_BLU[6:4]	6:4	R/W	0b101	Clamp Voltage, VONLINE (0V~700mV, Step=100mV)	
ADC_CTL_BLU[3]	3	R/W	0b0	Offset Depends on Gain (0: RGB Yes, YPrPb No 1:RGB No, YPrPb No)	
ADC_CTL_BLU[2:0]	2:0	R/W	0b0	Blue Channel ADC Fine Tune Delay, Step=90ps	

Register::ADC_SOG0_CTRL					0XD2
Name	Bit	R/W	Default	Description	Config
Reserved	7:6	---	--	Reserved	
ADC_SOG0_CTRL	5:0	R/W	6'h20	SOG Reference Control 0-630mV, Step=10mV (Default: 100000)	

Register:: ADC_DCR_CTRL[7:0]					0XD3
Name	Bit	R/W	Default	Description	Config
ADC_DCR_CTRL[7]	7	R/W	0	Red_0 DC Restore Enable (0:Disable 1:Enable)	
ADC_DCR_CTRL[6]	6	R/W	0	Green_0 DC Restore Enable (0:Disable 1:Enable)	
ADC_DCR_CTRL[5]	5	R/W	0	Blue_0 DC Restore Enable (0:Disable 1:Enable)	

ADC_DCR_CTRL[4]	4	R/W	0	SOG0 DC Restore Enable(0:Disable 1:Enable)	
ADC_DCR_CTRL[3]	3	R/W	0	Red_1 DC Restore Enable (0:Disable 1:Enable)	
ADC_DCR_CTRL[2]	2	R/W	0	Green_1 DC Restore Enable (0:Disable 1:Enable)	
ADC_DCR_CTRL[1]	1	R/W	0	Blue_1 DC Restore Enable (0:Disable 1:Enable)	
ADC_DCR_CTRL[0]	0	R/W	0	SOG1 DC Restore Enable(0:Disable 1:Enable)	

Register:: ADC_CLAMP_CTRL0[7:0]				0XD4	
Name	Bit	R/W	Default	Description	Config
ADC_CLAMP_CTRL0[7]	7	R/W	0	Red_0 Clamp Enable (0: Disable 1:Enable)	
ADC_CLAMP_CTRL0[6]	6	R/W	0	Green_0 Clamp Enable (0: Disable 1:Enable)	
ADC_CLAMP_CTRL0[5]	5	R/W	0	Blue_0 Clamp Enable (0: Disable 1:Enable)	
ADC_CLAMP_CTRL0[4]	4	R/W	0	SOG0 Clamp Enable(0:Disable 1:Enable)	
ADC_CLAMP_CTRL0[3]	3	R/W	0	Red_1 Clamp Enable (0: Disable 1:Enable)	
ADC_CLAMP_CTRL0[2]	2	R/W	0	Green_1 Clamp Enable (0: Disable 1:Enable)	
ADC_CLAMP_CTRL0[1]	1	R/W	0	Blue_1 Clamp Enable (0: Disable 1:Enable)	
ADC_CLAMP_CTRL0[0]	0	R/W	0	SOG1 Clamp Enable(0:Disable 1:Enable)	

Register:: ADC_CLAMP_CTRL1[7:0]				0XD5	
Name	Bit	R/W	Default	Description	Config
ADC_CLAMP_CTRL1[7]	7	R/W	0	Reserved	
ADC_CLAMP_CTRL1[6]	6	R/W	0	R,G,B,SOG Clamp Voltage VOFFLINE (0: 500mV, 1:	

				200mV)	
ADC_CLAMP_C TRL1[5:4]	5:4	R/W	0	Red Channel Clamp Voltage, VONLINE 00: clamp to black- Low clamp 01: clamp to black-Middle clamp 10: clamp to sync 11: clamp to top	
ADC_CLAMP_C TRL1[3:2]	3:2	R/W	0	Green Channel Clamp Voltage, VONLINE 00: clamp to black- Low clamp 01: clamp to black-Middle clamp 10: clamp to sync 11: clamp to top	
ADC_CLAMP_C TRL1[1:0]	1:0	R/W	0	Blue Channel Clamp Voltage, VONLINE 00: clamp to black- Low clamp 01: clamp to black-Middle clamp 10: clamp to sync 11: clamp to top	

Register:: ADC_SOG_CTRL[7:0]				0XD6	
Name	Bit	R/W	Default	Description	Config
ADC_SOG_CTRL[7]	7	R/W	0	Reserved	
ADC_SOG_CTRL[6:4]	6:4	R/W	000	SOG1 input MUX select (000: SOG1 001:B1 010:G1 011:R1 100: SOG0 101:B0 110:G0 111:R0	
ADC_SOG_CTRL[3:2]	3:2	R/W	01	Input0 DC Restore Resistor (00:floating, C=47n 01:Poly R=500K, C=10n) (10:MOS R=1M, C=4.7n 11:MOS R=5M, C=1n)	
ADC_SOG_CTRL[1:0]	1:0	R/W	01	Input1 DC Restore Resistor (00:floating, C=47n	

				01:Poly R=500K, C=10n) (10:MOS R=1M, C=4.7n 11:MOS R=5M, C=1n)	
--	--	--	--	--	--

Realtek Confidential for GM Only

ABL(Page 0)
Address: E2 AUTO_BLACK_LEVEL_CTRL1 Default: 00h

Bit	Mode	Function
7	R/W	ABL Mode 0: RBG (Default) 1: YPbPr
6	R/W	On-line/Off-line ABL Mode 0: Off-line (Default) 1: On-line
5:4	R/W	Width of ABL region in each line 00: 16 pixels (Default) 01: 32 pixels 10: 64 pixels 11: 4 pixels
3	R	R/Pr Channel ABL Result (write clear) 0: not equal 1: equal (Black Level = Target Value) On-line mode: Black Level - Target Value <= LOCK_MGN Off-line mode: Black Level - Target Value <= EQ_MGN
2	R	G/Y Channel ABL Result (write clear) 0: not equal 1: equal (Black Level = Target Value) On-line mode: Black Level - Target Value <= LOCK_MGN Off-line mode: Black Level - Target Value <= EQ_MGN
1	R	B/Pb Channel ABL Result (write clear) 0: not equal 1: equal (Black Level = Target Value) On-line mode: Black Level - Target Value <= LOCK_MGN Off-line mode: Black Level - Target Value <= EQ_MGN
0	R/W	Auto Black Level Enable (write 0 force stop) 0: Finished/Disable (Default) 1: Enable to start ABL, auto cleared after finished Cleared to 0 when off-line mode completes.

Address: E3 AUTO_BLACK_LEVEL_CTRL2 Default: 84h

Bit	Mode	Function
7:6	R/W	Line averaged for each ABL adjustment

		00: 8 01: 16 10: 32 (Default) 11: 64
5	--	Reserved
4:0	R/W	Start Vertical Position of ABL in each line Determine the start line of auto-black-level after the leading edge of Vsync

Address: E4 **AUTO_BLACK_LEVEL_CTRL3** **Default: 10h**

Bit	Mode	Function
7:4	R/W	Y/R/G/B Target value 0000: 1 0001: 2 (Default) 0010: 3 0011: 4 1111:16 (Pb/Pr Target level is fixed 128)
3:2	R/W	Lock Margin 00: 1 (Default) 01: 2 10: 4 11: 6
1:0	R/W	End Vertical Position of ABL measurement region [9:8] Determine the last line of auto-black-level measurement for every frame/field counted by double line

Address: E5 **AUTO_BLACK_LEVEL_CTRL4** **Default: 82h**

Bit	Mode	Function
7:0	R/W	End Vertical Position of ABL measurement region [7:0] Determine the last line of auto-black-level measurement for every frame/field counted by double line.

Address: E6 **AUTO_BLACK_LEVEL_CTRL5** **Default: 04h**

Bit	Mode	Function
7:0	R/W	Start Position of ABL in Each Line Determine the start position of auto-black-level after the trailing edge of reference signal. (When ABL mode in YPbPr, the reference signal is input Hsync. In RGB mode, the reference signal is clamp signal.)

- I In each region, hardware compare the average value in the target region (fixed 16 input pixels after start position of ABL) with target value and add +1/-1 or +L_MGN /- L_MGN to ADC offset. (+ for greater than target value, - for smaller than target value).

Address: E7 **AUTO_BLACK_LEVEL_CTRL6** **Default: C0h**

Bit	Mode	Function
7:6	R/W	Large Error Margin (L_MGN) (For on-line Mode) 00: 2 01: 4 10: 6 11: 8 (Default)
5:4	R/W	Max. Frame/Field Count (For off-line mode) 00: 4 (Default) 01: 5 10: 6 11: 7
3	--	Reserved
2:0	R/W	Lines delayed between each measurement region (For on-line Mode) 000: 16 (Default) 001: 32 010: 64 011: 128 100: 192 101: 256 110: 384 111: 640

Address: E8 **AUTO_BLACK_LEVEL_CTRL7** **Default: 20h**

Bit	Mode	Function
7	--	Reserved
6	R/W	Equal Condition (Off-line mode) 0: To trigger status once if Black Level - Target Value <= EQ_MGN. (Default) 1: To trigger status until measurement achieve Max Frame/Field Count. (If set 0, the ABL Result will not go low even noise comes for the next frames.)
5	R/W	Measure Pixels Method 1: Minimum value (Default) 0: Average value
4	R/W	Measure Error Flag Reset

		0: Normal 1: Reset
3	R	Measure Error Flag 0: Normal 1: Error (This flag is occurred when Hsync trailing edge is met during measurement.)
2	R/W	Hsync Start Reference Select 0: HS leading edge (Default) 1: HS trailing edge
1:0	R/W	Equal margin (EQ_MGN) 00: 0 (Default) 01: 1 10: 2 11: 3

Address: E9 AUTO_BLACK_LEVEL_RED_VALUE

Bit	Mode	Function
7:0	R	Minimum/Average Value of Red Channel in Test Mode

Address: EA AUTO_BLACK_LEVEL_GREEN_VALUE

Bit	Mode	Function
7:0	R	Minimum/Average Value of Green Channel in Test Mode

Address: EB AUTO_BLACK_LEVEL_BLUE_VALUE

Bit	Mode	Function
7:0	R	Minimum/Average Value of Blue Channel in Test Mode

Address: EC AUTO_BLACK_LEVEL_NOISE_VALUE_OF_RED_CHANNEL

Bit	Mode	Function
7:0	R	Noise Value of Red Channel in Test Mode after Equal status is triggered.

Address: ED AUTO_BLACK_LEVEL_NOISE_VALUE_OF_GREEN_CHANNEL

Bit	Mode	Function
7:0	R	Noise Value of Green Channel in Test Mode after Equal status is triggered.

Address: EE AUTO_BLACK_LEVEL_NOISE_VALUE_OF_BLUE_CHANNEL

Bit	Mode	Function
7:0	R	Noise Value of Blue Channel in Test Mode after Equal status is triggered.

Address 0xEF~0xF2 are reserved

LVR(Page 0)
Address: F3 POWER_ON_RESET
Default:94h

Bit	Mode	Function
7:6	R/W	Negative Threshold Value For Power on Reset 00:1.8V 01:2.0V 10:2.2V(Default) 11:2.4V
5:0	R/W	Reserved to 0

Schmitt trigger
Address:F4 HS_SCHMITT_TRIGGE_CTRL
Default:E1h

Bit	Mode	Function
7	R/W	HSYNC Schmitt Power Down (Only for Schmitt trigger new mode) 0: Power down 1: Normal (Default)
6	R/W	Polarity Select 0: Negative HSYNC (high level) 1: Positive HSYNC (low level) (Default)
5	R/W	Schmitt Trigger Mode 0: Reserved 1: New mode
4	R/W	Threshold Voltage Fine Tune (only for Schmitt trigger new mode) 0: 0V (Default) 1: -0.1V
3:2	R/W	Positive Threshold Voltage
1:0	R/W	Negative Threshold Voltage

There is a mode of the HSYNC Schmitt trigger.

1. New mode: Fully programmable Schmitt trigger.

The following table will determine the Schmitt Trigger positive and negative voltage:

bit[6]=1 (Positive HSYNC)				bit[6] = 0 (Negative HSYNC)			
bit[3:2]	V _t ⁺	bit[1:0]	V _t ⁻	bit[3:2]	V _t ⁺	bit[1:0]	V _t ⁻
00	1.4V	00	V _t ⁺ - 1.2V	00	1.8V	00	V _t ⁺ - 1.2V
01	1.6V	01	V _t ⁺ - 1.0V	01	2.0V	01	V _t ⁺ - 1.0V
10	1.8V	10	V _t ⁺ - 0.8V	10	2.2V	10	V _t ⁺ - 0.8V
11	2.0V	11	V _t ⁺ - 0.6V	11	2.4V	11	V _t ⁺ - 0.6V

After we get the threshold voltage by the table, we still can fine tune it:

$$\text{Final Positive Threshold Voltage} = V_t^+ - 0.1 * \text{bit}[4]$$

$$\text{Final Negative Threshold Voltage} = V_t^- - 0.1 * \text{bit}[4]$$

ADC PLL (Page 1)
Address: A0 PLL_DIV_CTRL
Default: 08h

Bit	Mode	Function
7	R/W	DDS Tracking Edge 0: HS positive edge (Default) 1: HS negative edge
6	R/W	Tracking direction inversion 0: if HS leads HSFB => phase lead => m, k ↑ (Default) 1: if HS lags HSFB => phase lag => m, k ↓
5:4	R/W	Waiting HS lines to start counting divider for Fast Lock function 00: 4 (default) 01: 3 10: 2 11: 1
3:2	R/W	Delay Compensation Mode 00: Mode 0 No delay from PLL phase0 to DDS pfd input 01: Mode 1 Delay the path from PLL phase0 to DDS pfd input to be around 4.2 ns 10: Mode 2 (default) Delay the path from PLL phase0 to DDS pfd input to be around 4.6 ns 11: Mode 3 Delay the path from PLL phase0 to DDS pfd input to be around 5 ns
1	R/W	Reserved to 0
0	R/W	Reserved to 0

Address: A1
I_CODE_M
Default: 01h

Bit	Mode	Function
7	R/W	Reserved to 0
6:0	R/W	I_CODE[14:8]

Address: A2
I_CODE_L
Default: 04h

Bit	Mode	Function
7:0	R/W	I_CODE[7:0]

Address: A3
P_CODE
Default: 20h

Bit	Mode	Function
7:0	R/W	P_CODE[7:0]

Address: A4
PFD_CALIBRATED_RESULTS_H
Default: 8'b0xxxxxxx

Bit	Mode	Function
7	R/W	PFD Calibration Enable (auto clear when finished) Overwrite 0 to 1 return a new PFD calibrated value.
6:4	R/W	Reserved to 0
3:0	R	PFD Calibrated Results [11:8]

Address: A5
PFD_CALIBRATED_RESULTS_L
Default: 8'bxxxxxxx

Bit	Mode	Function
7:0	R	PFD Calibrated Results [7:0]

Address: A6
PE_MEASURE_H
Default: 8'b0xxxxxxx

Bit	Mode	Function
7	R/W	PE Measure Enable (auto clear when finished) 0: Disable (Default) 1: Start PE Measurement, clear after finish.
6:4	R/W	Reserved to 0
3:0	R	PE Value Result [11:8]
Address: A7		PE_MEASURE_L Default: 8'bxxxxxxx
Bit	Mode	Function
7:0	R	PE Value Result [7:0]
Address: A8		PE_MAX_MEASURE_H Default: 8'b0xxxxxxx
Bit	Mode	Function
7	R/W	PE Max. Measure Enable 0: Disable (Default) 1: Start PE Max. Measurement
6:4	R/W	Reserved to 0
3:0	R	PE Max Value [11:8]
Address: A9		PE_MAX_MEASURE_L Default: 8'bxxxxxxx
Bit	Mode	Function
7:0	R	PE Max Value [7:0]
Address: AA		FAST_PLL_CTRL Default: 00h
Bit	Mode	Function
7	R/W	PE Max. Measure Clear 0: clear (Default) 1: write '1' to clear PE Max. Value
6	R/W	Enable APLL Setting 0: Disable (Default) 1: Enable (Auto clear when finished) When CR AA[5] enabled, enable this bit will write P_CODE, I_CODE, PLL M/N, PLL K, PLLDIV and DDS SUM_I at the end of input vertical data enable
5	R/W	Enable Fast PLL Mechanism 0: Disable (Default) 1: Enable (Auto clear when finished)
4	R/W	Force APLL Setting Enable Force to write PLL M/N, K, PLLDIV and SUM_I while got no V_ACTIVE signal 0: Disable (Default) 1: Enable (Auto clear when finished)

3	R/W	DDS SUM_I Setting Updated Enable 0: Disable (Default) 1: Enable (Auto clear when finished)
2	R/W	Measure SUM_I 0: Disable 1: Enable (Auto clear after finish)
1	R/W	Enable Port A3 0: Disable Port A3 Access 1: Enable Port A3 Access When this bit is 0, port address will be reset to 00, and will auto increase when read or write
0	R/W	Select SUM_I for Read 1: Select SUM_I_NOW [26:0] for read 0: Select SUM_I_PRE [26:0] for read

Address: AB FAST_PLL_SUM_I

Bit	Mode	Function
7:0	R/W	SUM_I_PRE (Auto Increase) 1 st [00000, SUM_I [26:24]] 2 nd SUM_I [23:16] 3 rd SUM_I [15:8] 4 th SUM_I [7:0]

Address: AC PLL_M (M Parameter Register) Default: 09h

Bit	Mode	Function
7:0	R/W	PLLM 7:0] (PLL DPM value – 3)

Address: AD PLL_N (N Parameter Register) Default: 20h

Bit	Mode	Function
7:4	R/W	PLLSPHNEXT[3:0] (K) (default is 0000)
3	R/W	PLLSNBP 0: N is followed by the value of REG A5 [3:1] 1: N is always 1
2:0	R/W	PLLN[2:0] (PLL DPN value – 2) (default is 000) It is supposed to be always bigger than 2

- I PLL1_N modify to only 4-bit.
- I Assume PLL1_M=0x0B, P1M=0x0B+3=14; PLL1_N=0x03, P1N=0x03+2=5; K=7; F_IN = 24.576MHz. $F_{PLL} = F_{IN} \times ((P1M+7/16) / P1N) = 24.576 \times 14.4375 / 5 = 70.9632\text{MHz}$
- I If the target frequency is F_ADC, the constraint of F_PLL is $(M+7/16)/N * XTCLK < F_{PLL1} < (M+8/16)/N * XTCLK$
- I Although the new dds provides +15/-16 phase margin for tracking. However it is better not to set M, N and K to be some freq. that PLL has to swallow +15/-16 phases. Because under that condition, SDM will get saturation problem.

- l For NO shrink IC => PLLN setting will have no limitation
- l For shrink IC and timing factor predicted as 0.8 => crystal clock 27 MHz => PLLN can't be 0 while APLL VCO is lower than 167MHz
crystal clock 24.576 MHz => PLLN can't be 0 while APLL VCO is lower than 84 MHz
- l For shrink IC and timing factor predicted as 0.9 => crystal clock 27 MHz => PLLN can't be 0 while APLL VCO is lower than 74 MHz
crystal clock 24.576 MHz => PLLN can't be 0 while APLL VCO is lower than 52 MHz

Address: AE PLL_CRNT (PLL Current/Resistor Register) Default: 63h

Bit	Mode	Function
7:5	R/W	PLLVR [2:0] (PLL Loop Filter Resister Control) 000: 20K 001: 21K 010: 22K 011: 23K (Default) 100: 24K 101: 25K 110: 26K 111: 27K
4:0	R/W	PLLSI [4:0] (PLL Charger Pump Current IchDpll) (Default: 00011b) $I_{cp} = 2.5\mu A + 2.5\mu A * bit[0] + 5\mu A * bit[1] + 10\mu A * bit[2] + 20\mu A * bit[3]$

- l **Keep Icp/DPM constant**

Address: AF PLL_WD (PLL Watch Dog Register) Default: 09h

Bit	Mode	Function
7	R	PLLSTATUS (PLL WD Status) 0: Normal (Default) 1: Abnormal
6	R/W	PLLWDRST (PLL WD Reset) 0: Normal (Default) 1: Reset
5	R/W	PLLWDSET (PLL WD Set) 0: Normal (Default) 1: Set
4:3	R/W	PLLWDVSET[1:0] (PLL WD Voltage Set) 00: 2.46V 01: 1.92V(Default) 10: 1.36V 11: 1.00V
2	R/W	<u>HS_dds2svnp latch edge</u> 0: falling edge (default)

		1: rising
1	R/W	Reset DDS 0: normal (default) 1: reset whole DDS
0	R/W	PLLPWDN (PLL Power Down) 0: Normal Run 1: Power Down (Default)

1 HSFb_dds2synp & HS_dds2synp will be both sampled by AF [2]

Address: B0 PLL_MIX Default: 8'b0000_000x

Bit	Mode	Function
7	R/W	PLLSVR3
6	---	Reserved to 0
5	R/W	PLLSVC3
4	---	Reserved to 0
3	---	Reserved to 0
2:1	R/W	ADCKMODE [1:0] (ADC Input Clock Select Mode) 00: Single Clock Mode (Default) 01: Single Inverse-Clock Mode 10: External Clock Mode 11: Dual Clock Mode (1x and 2x Clock)
0	R	Swallow phase enable (K mask disabled) The pll can't enable swallow phase function while pll just be power up. Waiting for 64 clock cycles then start to enable phase swallow function. While power down, the counter will be reset. While power up, the counter start to work

Address: B1 PLLDIV_H Default: 45h

Bit	Mode	Function
7	---	Reserved to 0
6	R/W	Phase_Select_Method 0: Manual 1: Look-Up-Table (default)
5	R/W	PLLPH0PATH 0: Short Path (Default) 1: Long Path (Compensate PLL_ADC path delay)
4	R/W	PLLD2 0: ADC CLK=1/2 VCO CLK (Default) 1: ADC CLK=1/4 VCO CLK
3:0	R/W	PLL Divider Ratio Control. High-Byte [11:8]. (Default: 5h)

Address: B2 **PLLDIV_L** **Default: 2Eh**

Bit	Mode	Function
7:0	R/W	PLL Divider Ratio Control. Low-Byte [7:0]. PLLDIV should be double buffered when PLLDIV_LO changes and IDEN_STOP occurs.

- I This register determines the number of output pixel per horizontal line. PLL derives the sampling clock and data output clock (DCLK) from input HSYNC. *The real operation Divider Ratio = PLLDIV+1*
- I The power up default value of PLLDIV is 053Fh(=1343, VESA timing standard, 1024x768 60Hz, Horizontal time).
- I The setting of PLLDIV must include sync, back-porch, left border, active, right border, and front-porch times.
- I Control-Register B1 & B2 will filled in when Control-Register B2 is written.

Address: B3 **PLLPHASE_CTRL0 (Select Phase to A/D)** **Default: 30h**

Bit	Mode	Function
7	R/W	PLLD2X control (Default=0)
6	R/W	PLLD2Y control (Default=0)
5	R/W	PLLX (PLL X Phase control) (Default=1)
4	R/W	PLLY (PLL X Phase control) (Default=1)
3:0	R/W	PLLSCK [4:1] (PLL 32 Phase Pre-Select Control) (Default=0h)

Address: B4 **PLLPHASE_CTRL1 (Select Phase to A/D)** **Default: 00h**

Bit	Mode	Function
7	R/W	PLLSCK [0] (PLL 32 Phase Pre-Select Control) (Default=0)
6	R/W	MSB of 128 phase (Only for ADC CLK=1/4 VCO CLK) (Default=0)
5:0	R/W	Phase Select the index of Look-Up-Table[5:0] (Default=0)

- I When Phase_Select_Method=1, Phase is selected by CRB4[6:0].
- I When Phase_Select_Method=0, PLLD2X, PLLD2Y, PLLX, PLY, PLLSCK[4:0] Should be double buffered when PLLSCK[0] is updated

Address: B5 **PLL_PHASE_INTERPOLATION** **Default: 50h**

Bit	Mode	Function
7:6	R/W	PLL Phase Interpolation Control Load (Default: 01)
5:3	R/W	PLL Phase Interpolation Control Source (Default: 010)
2:1	R/W	PLL Add Phase Delay 00: Original phase selected by X,Y and 16-phase pre-select 01-11: Add 1-3 delay to Original phase selected by X,Y and 32-phase pre-select
0	R/W	Reserved to 0

Phase	[XY ^^^^^]	Phase	[XY ^^^^^]	Phase	[XY ^^^^^]	Phase	[XY ^^^^^]
0	[11 00000]	16	[01 10000]	32	[10 00000]	48	[00 10000]
1	[11 00001]	17	[01 10001]	33	[10 00001]	49	[00 10001]
2	[11 00010]	18	[01 10010]	34	[10 00010]	50	[00 10010]

		1100: reserved to 0 1101: reserved to 0 1110: reserved to 0 1111: reserved to 0
1	R/W	Adaptive tracking enable for I_CODE 0: disable to use adaptive I_CODE (default) 1: enable to use adaptive I_CODE
0	R/W	Adaptive tracking enable for P_CODE 0: disable to use adaptive P_CODE (default) 1: enable to use adaptive P_CODE

Address: B7 PE tracking method Default: 02h

Bit	Mode	Function
7:6	R/W	Threshold value of Q (PE) to decide if starting adaptive tracking 00: 2 (default) 01: 4 10: 8 11: 15
5:4	R/W	Threshold times to decide if starting adaptive tracking while Q(PE) < Threshold value successively 00: 3 (default) 01: 7 10: 11 11: 15
3	R/W	Mask high speed testing pins (test1out, test2out, fav4) 0: normal 1: mask
2	R/W	Adaptive tracking enable => refer to B6 [1:0] to decide if I_CODE or P_CODE enables adaptive tracking or not 0: disable (default) 1: enable
1:0	R/W	Decrease ratio for adaptive tracking Adaptive tracking will be enabled while getting Q (PE) <=2 for over 8 times, and it will be triggered only under delay-chain mode 00: 1/2 01: 1/4 10: 1/8 (default)

		11: 1/16
--	--	----------

Address: B8 **DDS_MIX_1** **Default: 06h**

Bit	Mode	Function
7:6	R	DDS tracking state [1:0] 00: not lock 01: lock 10: unlock but not using new tracking mode yet 11: unlock & using new tracking mode
5:4	R/W	Reserved to 0
3:1	R/W	Judge threshold lock already => while Q (PE) keep smaller than threshold for 32 HS 000: 2 001: 4 010: 6 011: 8 (default) 100: 16 101: 32 110: 64 111: 120
0	R	PLL lock already 0: not lock already 1: lock already

Address: B9 **DDS_MIX_2** **Default: 00h**

Bit	Mode	Function
7:0	R/W	P_code_max[16:9] Set p_code_max value to clamp the GAIN of APLL

Address: BA **DDS_MIX_3** **Default: 00h**

Bit	Mode	Function
7:0	R/W	P_code_max[8:1] Set p_code_max value to clamp the GAIN of APLL

Address: BB **DDS_MIX_4** **Default: 1Bh**

Bit	Mode	Function
7	R/W	P_code_max[0] Set p_code_max value to clamp the GAIN of APLL

6	R/W	New mode enable 0: disable new mode tracking (default) 1: enable new mode tracking
5:3	R/W	New mode enable threshold 000: 8 001: 20 010: 60 011: 120 (default) 100: 200 101: 450 110: 800 111: 1200
2:0	R/W	New mode lock threshold=> while Q (PE) keep smaller than threshold for 32 HS 000: 2 001: 4 010: 6 011: 8 (default) 100: 16 101: 32 110: 64 111: 120

- I** New mode enable threshold should be larger than new mode lock threshold, otherwise, the track state will always be at lock state and new mode function will not be enabled while new mode enable threshold < Q (PE) < new mode lock threshold

Address: BC
DDS_MIX_5
Default: A0h

Bit	Mode	Function
7:6	R/W	Delay chain length select (only valid while new mode enable and track state is 01 10 11) 00: cnt=7 => 59.6ns 01: cnt=15 => 117ns 10: cnt=23 => 184.4ns (default) 11: cnt=31 => 246.8ns
5:4	R/W	Phase error sample period choose (only valid while new mode enable and track state is 01 10 11) 00: every 1 cycle sample 01: every 2 cycle sample 10: every 3 cycle sample (default)

		11: every 4 cycle sample
3	R/W	Delay chain reset period select 0: short reset (2ns) (default) 1: long reset (1 fbck)
2	R/W	Reset delay chain saturation flag 0: normal (default) 1: reset flag
1	R	Delay chain saturation flag 0: not saturate 1: saturate => it need to enlarge the sample period or set bigger N code
0	R/W	APLL_free_run enable 0: normal state (default) 1: force APLL to free run state

While we got delay chain saturation flag 1'b1, that means that the big jitter is bigger than what we image and we have to reset the delay chain length setting BC [7:6]. Also we have to enlarge the sampling period & delay chain length

The choice for sampling period will be set by the rule as following:

(Delay chain length * 78 + 50) * each tap delay + 10(ns) must be < N * T_{XCLK} * sample period

if delay chain saturation flag goes high, then we must enlarge the delay chain length & set bigger sampling period

While we enable free run mode, DDS will keep reset status until disable free run

Address: BD **DDS_MIX_6**

Bit	Mode	Function
7:0	R	Final M code to APLL

While we like to read final M code & K code, we have to enable measure PE 9E[7] first. Otherwise we will get glitch value

Address: BE **DDS_MIX_7** **Default: 00h**

Bit	Mode	Function
7:4	R	Final K code to APLL
3:1	R/W	Change mode threshold => triggered by any Q (PE) > threshold 000: 600 (default) 001: 850 010: 1100 011: 1350 100: 1600 101: 1850 110: 2100 111: 2350

0	R/W	new_mode_i_code_en 0: while new mode enable, I code will have no effect on SUM_I. All phase error will be compensated by P code (default) 1: while new mode enable, I code will be operated as normal state
---	-----	--

For APLL interrupt status that include 4 different types:

No lock: initial is 1 => over lock threshold B8 [3:1] => 1

Wait state: initial is 1 => valid only while u enable new mode => over new mode enable threshold BB [5:3] => 1

New mode state: initial is 1 => valid only while u enable new mode => over new mode lock threshold BB [2:0] => 1

Change mode happen state: initial is 1 => over change mode threshold BE [3:1] => 1

DISPLAY PLL (Page 1)

Address: BF DPLL_M (DPLL M Divider Register) Default: 2Ch

Bit	Mode	Function
7:0	R/W	DPLLM[7:0] (DPLL DPM value – 2)

Address: C0 DPLL_N (DPLL N Divider Register) Default: 83h

Bit	Mode	Function
7	R/W	DPLLPWDN (DPLL Power Down) 0: Normal Run 1: Power Down (Default)
6	R/W	DPLLFREEZE (DPLL Output Freeze) 0: Normal (Default) 1: Freeze
5:4	R/W	DPLLO[1:0] (DPLL Output Divider) 00: Div1 (Default) 01: Div2 10: Div4 11: Div8
3:0	R/W	DPLLN[7:0] (DPLL DPN value – 2) (Default: 3h)

Assume $DPLL_M=0x7D$, $DPM=0x7D+2=127$; $DPLL_N=0x0A$, $DPN=0x0A+2=12$; $Divider=1/4$, $F_IN = 24.576MHz$. $F_DPLL = F_IN \times DPM / DPN \times Divider = 24.576 \times 127 / 12 / 4 = 65.024MHz$.

If $LPF_Mode = 1$, suppose $DPM=110$, $DPN = 12$, $I_{ch} = I_{dch}[0010] = 3.0\mu A$, $DPLL=225MHz$, then $DPM / I_{ch} = 36.67$. Please keep the ratio as constant.

If $LPF_Mode = 0$, suppose $DPM=46$, $DPN = 5$, $I_{ch} = I_{dch} [1000] = 9.0\mu A$, $DPLL=226MHz$, then $DPM / I_{ch} = 5.11$. Please keep the ratio as constant.

Address: C1 DPLL_CRNT (DPLL Current/Resistor Register) Default: 88h

Bit	Mode	Function
7:6	R/W	DPLLVR[1:0] (DPLL Loop Filter Resister Control) 00: 16K (LPF Mode = 0), 46K (LPF Mode = 1)

		01: 18K (LPF Mode = 0), 53K (LPF Mode = 1) 10: 20K (LPF Mode = 0), 60K (LPF Mode = 1) (Default) 11: 22K (LPF Mode = 0), 67K (LPF Mode = 1) (Default)
5:4		Reserved
3:0	R/W	DPLLSI[3:0] (DPLL Charger Pump Current IchDpll) (Default: 1000) Icp=(1uA+1uA*bit[0]+2uA*bit[1]+4uA*bit[2]+8uA*bit[3])

I Keep Icp/DPM constant

DCLK Spread Spectrum (Page 1)

Address: C2 DPLL_WD (Watch Dog Register)

Default: 12h

Bit	Mode	Function
7	R	DPLLSTATUS (DPLL WD Status) 0: Normal 1: Abnormal
6	R/W	DPLLWDRST (DPLL WD Reset) 0: Normal (Default) 1: Reset
5	R/W	DPLLWDSET (DPLL WD Set) 0: Normal (Default) 1: Set
4:3	R/W	DPLLWDVSET[1:0] (DPLL WD Voltage Set) 00: 0.58V 01: 0.74V 10: 0.88V (Default) 11: 1.17V
2	---	Reserved
1	R/W	DPLLSTOP (DPLL Frequency Tuning Enable) 0: Disable 1: Enable (Default) Turn on before CRC2[0].
0	R/W	DPLLLPFMODE (DPLL LPF Mode) 0: DPN<=5 ⇒ LPFMode=0 Ich=9.15uA DPM=46 DPN=5 (Default) 1: 16>=DPN>=5 ⇒ LPFMode=1 Ich=3.2uA DPM=110 DPN=12

Address: C3 DPLL Other

Default: 16h

Bit	Mode	Function
7:5	--	Reserved
4	R/W	DPLL Clock to SSCG

		0: DPLL VCO/4 1: (DPLL VCO+Phase_Swallow)/4 (Default)
3	R/W	DPLL Reference Frequency Select 0: Original Crystal Clock (Default) 1: Clock After M2PLL
2	R/W	DPLL VCO RON (increase VCO_OP Phase Margin) 0: Disable 1: Enable (Default)
1	R/W	DPLL VCO START (startup VCO) 0: Disable (Default) 1: Enable
0	R/W	DPLL BPN (DPLL dividend enable) 0: DPLL_N dividend enable 1: N dividend disable

Address: C4 Initial DCLK_FINE_TUNE_OFFSET_MSB Default: 10h

Bit	Mode	Function
7	R/W	Linear change offset value function 0 : disable 1: enable (auto clear when finish) It should work on DDS Spread Spectrum Output function enable. When function is done, the initial offset and DPLLUPDN value would be the target offset and DPLLUPDN value.
6	R/W	Only Even / Odd Field Mode Enable 0: Disable (Default) 1: Enable
5	R/W	Even / Odd Field Select 0: Even (Default) 1: Odd
4	R/W	Initial DPLLUPDN (DPLL Frequency Tuning Up/Down) 0: Freq Up 1: Freq Down (Default)
3:0	R/W	Initial DCLK Offset [11:8] in Fixed Last Line DVTOTAL & DHTOTAL

Address: C5 Initial DCLK_FINE_TUNE_OFFSET_LSB Default: 00h

Bit	Mode	Function
7:0	R/W	Initial DCLK Offset [7:0] in Fixed Last Line DVTOTAL & DHTOTAL

Address: C6 DCLK_SPREAD_SPECTRUM Default: 00h

Bit	Mode	Function
7:4	R/W	DCLK Spreading range (0.0~7.5%) The bigger setting, the spreading range will bigger, but not uniform
3	R/W	Spread Spectrum FMDIV (SSP_FMDIV)/(0) 0: 33K 1: 66K
2	R/W	Spread Spectrum Setting Ready for Writing (Auto Clear) 0: Not ready 1: Ready to write
1:0	R/W	Frequency Synthesis Select (F & F-N*dF) 00~11: N=1~4

! The “Spread Spectrum Setting Ready for Writing” means 4 kinds of registers will be set after this bit is set:

1. DCLK spreading range
2. Spread spectrum FMDIV
3. DCLK offset setting
4. Frequency synthesis select

Address: C7 **EVEN_FIXED_LAST_LINE_MSB**

Bit	Mode	Function
6:4	R/W	Even Fixed Last Line Length [11:8]
3:0	R/W	Even Fixed DVTOTAL [11:8]

Address: C8 **EVEN_FIXED_LAST_LINE_DVTOTAL_LSB**

Bit	Mode	Function
7:0	R/W	Even Fixed DVTOTAL [7:0]

Address: C9 **EVEN_FIXED_LAST_LINE_LENGTH_LSB**

Bit	Mode	Function
7:0	R/W	Even Fixed Last Line Length [7:0]

! If Even / Odd mode disable, we use EVEN_FIXED_LAST only.

! If Even/Odd mode enable, the even / odd field would be reference different setting.

! Fixed last line value can't be zero, and can't smaller than DH_Sync width.

Address: CA **FIXED_LAST_LINE_CTRL** **Default: 00h**

Bit	Mode	Function
7:6	--	Reserved to 0
5	R/W	Measure the Phase about Fixed DVTOTAL & Last Line DHTOTAL Function 0 : Disable 1 : Enable (Auto clear when finish)
4	R/W	Mark Phase tracking about Fixed DVTOTAL & Last Line DHTOTAL Function 0 : Disable

		1 : Enable
3	R/W	Enable New Design Function in Fixed Last Line Mode 0: Disable (Default) 1: Enable
2	R/W	DDS Spread Spectrum Test Enable 0: Disable (Default) 1: Enable
1	R/W	Enable the Fixed DVTOTAL & Last Line DHTOTAL Function 0: Disable (Default) 1: Enable
0	R/W	Enable DDS Spread Spectrum Output Function 0: Disable (Default) 1: Enable

Address: CB ODD_FIXED_LAST_LINE_MSB

Bit	Mode	Function
6:4	R/W	ODD Fixed Last Line Length [11:8]
3:0	R/W	ODD Fixed DVTOTAL [11:8]

Address: CC ODD_FIXED_LAST_LINE_DVTOTAL_LSB

Bit	Mode	Function
7:0	R/W	ODD Fixed DVTOTAL [7:0]

Address: CD ODD_FIXED_LAST_LINE_LENGTH_LSB

Bit	Mode	Function
7:0	R/W	ODD Fixed Last Line Length [7:0]

Address: CE DCLK_SPREAD_SPECTRUM

Default: 00h

Bit	Mode	Function
7:2	R/W	Reserve
1	R	Fixed Last Line Tracking time hit Field one 0 : hit field zero (If field zero is odd à hit odd field) 1: hit field one (If field one is even à hit even field)
0	R	IVS Lead/Lag to DVS 0 : Lag 1 : Lead

Address: CF PHASE_RESULT_MSB

Bit	Mode	Function
6:4	R	Phase Line [11:8]

3:0	R	Phase Pixel [11:8]
-----	---	--------------------

Address: D0 PHASE_LINE_LSB

Bit	Mode	Function
7:0	R	Lead Phase Line [7:0]

Address: D1 PHASE_PIXEL_LSB

Bit	Mode	Function
7:0	R	Lead Phase Pixel [7:0]

Address: D2 Target DCLK_FINE_TUNE_OFFSET_MSB Default: 10h

Bit	Mode	Function
7:5	R/W	Reserve to 0
4	R/W	Target DPLLUPDN (DPLL Frequency Tuning Up/Down) 0: Freq Up 1: Freq Down (Default)
3:0	R/W	Target DCLK Offset [11:8] in Fixed Last Line DVTOTAL & DHTOTAL

Address: D3 Target DCLK_FINE_TUNE_OFFSET_LSB Default: 00h

Bit	Mode	Function
7:0	R/W	Target DCLK Offset [7:0] in Fixed Last Line DVTOTAL & DHTOTAL

Address 0xD4~0xDF are reserved

MULTIPLY PLL (Page 1)

Address: E0 MULTI_PLL_CTRL0 Default: 82h

Bit	Mode	Function
7:3	R/W	M2PLL M Code[4:0]-2 (DPM) Default = 18 => 10000'b
2	R/W	M2PLL Output Freeze 0: Normal (Default) 1: Freeze i.e.: when output is frozen, the internal PLL is still operating
1	R/W	M2PLL N Code 0: N=1 1: N=2 (Default)
0	R	M2PLL WD Status 0: Normal 1: Abnormal

Address: E1 MULTI_PLL_CTRL1 Default: 94h

Bit	Mode	Function
-----	------	----------

7:6	R/W	M2PLL Loop Filter Resistor Control 00: 15K 01: 18K 10: 21K (Default) 11: 24K
5:4	R/W	M2PLL Loop Filter Charge Current Control (Default:01) $I_{cp}=5\mu A+5\mu A*\text{bit}[4]+10\mu A*\text{bit}[5]$ i.e.: Keep $I_{cp}/M = 15\mu/8$
3:2	R/W	M2PLL WD Voltage 00: 0.80V 01: 1.0V (Default) 10: 1.2V 11: 1.4V
1	R/W	M2PLL_WDRST 0: Normal (Default) 1: Reset (M2PLL Function as a Normal PLL, regardless WD)
0	R/W	M2PLL_WDSET 0: Normal (Default) 1: Set (Free-Run by WD asserts VCO Voltage)

CRE2-E3 are not controlled by software reset.

Address: E4 **M2PLL power down** **default:0x01**

Bit	Mode	Function
7:1	---	Reserved
0	R/W	M2PLL Power Down 0: Normal Run (Default) 1: Power Down

Address 0xE5-0xE9 are reserved

PLL27X

Register::PLL CHARGE PUMP CURRENT					0XE A
Name	Bit	R/W	Default	Description	Config
PLL27X_IP[1:0]	7:6	R/W	00	Charge pump current control 100:20uA, 01:30uA, 10:40uA, 11:50uA	
PLL27X_RS[2:0]	5:3	R/W	011	Loop filter resistor control	

PLL27X_CS[2:0]	2:0	R/W	011	Loop filter capacitor control 000:27pF, 001:33.8pF, 010:40.6pF, 011:47.4pF 100:47.4pF, 101:54.2pF, 110:61pF, 111:67.8pF	
----------------	-----	-----	-----	---	--

Register:: Loop filter capacitor				0XE8	
Name	Bit	R/W	Default	Description	Config
PLL27X_CP[2:0]	7:5	R/W	110	Loop filter capacitor control 000:1.2pF, 001:1.43pF, 010:1.65pF, 011:1.88pF 100:2.11pF, 101:2.34pF, 110:2.57pF, 111:2.8pF	
PLL27X_EN	4	R/W	0	PLL enable control, high enable	
PLL27X_Vcot	3	R/W	1	VCO test mode control, 0: test mode 1: norml	
PLL27x_reset_n	2	R/W	1	0: Reset pll27x 1: normal run	
Rev	1:0	---	---	Reserved	

Register:: PLL test mode control				0XEC	
Name	Bit	R/W	Default	Description	Config
PLL27X_TST[4:0]	7:3	R/W	01111	PLL test mode control	
Rev	2:0	---	---	Reserved	

Address 0xED~0xEF are reserved

Address 0x72~0xFF are reserved

**Reserved Page3~page5
De-interlace(Page 6)**

Register:: enable and bist control					0xA0
Name	Bits	Read/Write	Reset State	Comments	Config
Rev	7:5	---		Reserved	
ne_en	4	R/W	0x0	Noise Estimation enable 0: Not Enable, 1: Enable,	
di_en	3	R/W	0x0	Deinterlace enable 0: Not Enable, 1: Enable,	
BIST_MODE	2	R/W	0x0	Bist enable 0: Not Enable, 1: Enable	
BIST_DONE	1	R	0x0	BIST DONE 0 : not Done 1 : Done	
BIST_FAIL_0	0	R	0x0	BIST TEST FAIL 0 when BIST_DONE 1: Success 1 when BIST_DONE 1: Fail	

1.2 Interpolation Control

Register::Interpolation_control					0xA1
Name	Bits	Read/Write	Reset State	Comments	Config
Rev	7:2	---		Reserved	
interp_range	2:0	R/W	0x3	Interpolation range 000:1 pixel 001:3 pixel 010:5 pixel 011:7 pixel 100~111:9 pixel	

1.3 Intra-Field Interpolation Thresholds (Low Angle)

Register:: Pixel_difference_threshold					0xA2
Name	Bits	Read/Write	Reset State	Comments	Config
la_th1	[7:0]	R/W	0x50	Pixel Difference Threshold (default : 0101 0000)	

Register:: Pixel_reference_difference_threshold					0xA3
Name	Bits	Read/Write	Reset State	Comments	Config
la_th2	[7:0]	R/W	0x1e	Pixel Reference Difference Threshold (default : 0001 1110)	

Register:: Gradient_threshold_positive					0xA4
Name	Bits	Read/Write	Reset	Comments	Config

		Write	State	
la_th1_p	[7:0]	R/W	0x15	Gradient Positive threshold (default : 0000 1111) [15]

Register:: Gradient_threshold_negative					0xA5
Name	Bits	Read/Write	Reset State	Comments	Config
la_th1_n	[7:0]	R/W	0x15	Gradient Negative threshold (default : 0000 1111) [-15]	

1.4 Post Processing Control

Register::Smoothing and Error Correction Control					0xA6
Name	Bits	Read/Write	Reset State	Comments	Config
Rev	7:4	---		Reserved	
mf_con_en	3	R/W	0x1	Median filter condition enable Under mf_en = 1 0 : all use the median value 1 : reference the condition	
mf_en	2	R/W	0x0	Median filter enable 0:output median filter not enable 1:output median filter enable	
lowpass_ena	1	R/W	0x1	Smooth Control Enable 0: Bypass smoothing 1: Enable smoothing	
impulse_ena	0	R/W	0x1	Error Correction control Enable 0: Bypass smoothing 1: Enable smoothing	

Register::Delete line and pixel enable					0xA7
Name	Bits	Read/Write	Reset State	Comments	Config
Rev	7:2	---		Reserved	
del_line_en	1	R/W	0x0	Delete line enable Delete up and down 2 lines (total 4 lines) after DI 0: don't delete any lines. 1: enable delete up and down 2 lines (only support reg_di_en = 1)	
del_pixel_en	0	R/W	0x0	Delete pixel enable Del left and right 4 pixels (total 8 pixels) after DI in 2 to 1 block 0: don't delete any pixel 1: enable delete left and right 4 pixels	

Register::Median filter threshold					0xA8
-----------------------------------	--	--	--	--	------

Name	Bits	Read/Write	Reset State	Comments	Config
Mf_th	7:0	R/W	0x0A	Median filter threshold	

Noise Estimation(Page 6)

1. Input parameter

Register:: Horizontal active size (MSB)					0xA9
Name	Bits	Read/Write	Reset State	Comments	Config
reserved_dummy	7:3	R/W	0	reserved_dummy	
hsize[10:8]	2:0	R/W	0x2	hsize[10:8] (MSB) Horizontal Active Window Size Noise Estimation Horizontal Active Window Size (width)	

Register:: Horizontal active size (LSB)					0xAA
Name	Bits	Read/Write	Reset State	Comments	Config
hsize[7:0]	7:0	R/W	0xd0	hsize[7:0] (LSB) Horizontal Active Window Size Noise Estimation Horizontal Active Window Size (width) hsize[10:0] default : 11'd720	

Register:: Vertical active size (MSB)					0xAB
Name	Bits	Read/Write	Reset State	Comments	Config
reserved_dummy	7:3	R/W	0	reserved_dummy	
vsize[10:8]	2:0	R/W	0x0	vsize[10:8] (MSB) Vertical Active Window Size Noise Estimation Vertical Active Window Size (height)	

Register:: Vertical active size (LSB)					0xAC
Name	Bits	Read/Write	Reset State	Comments	Config
vsize[7:0]	7:0	R/W	0xf0	vsize[7:0] (LSB) Vertical Active Window Size Noise Estimation Vertical Active Window Size (height) vsize[10:0] default : 11'd240	

2 Noise Estimation calculated region Control

Register:: Calculated Region Control					0xAD
Name	Bits	Read/Write	Reset State	Comments	Config
reserved_dummy	7:4	R/W	0	reserved_dummy	
h_ne_region	3:2	R/W	0x3	Horizontal Noise Estimation Region 00: hactive region. 01: hactive region without 16 point front part and 16 points end part. 10: hactive region without 32 point front part and 32 points end part.	

				11: hactive region without 64 point front part and 64 points end part. Default : 11	
v_ne_region	1:0	R/W	0x3	Vertical Noise Estimation Region 00: vactive region. 01: vactive region without 4 lines top part and 4 lines bottom part. 10: vactive region without 8 lines top part and 8 lines bottom part. 11: vactive region without 16 lines top part and 16 lines bottom part. Default : 11	

3 Noise Estimation spatial noise value

Register:: Noise Estimation hactive start point (MSB)					0xAE
Name	Bits	Read/Write	Reset State	Comments	Config
reserved_dummy	7:3	R/W	0	reserved_dummy	
ne_hstart1[10:8]	2:0	R/W	0x0	ne_hstart1[10:8] (MSB) Prevent from hactive larger than 720 Choose the start point of one line Range 1~1920	

Register:: Horizontal active size (LSB)					0xAF
Name	Bits	Read/Write	Reset State	Comments	Config
ne_hstart1[7:0]	7:0	R/W	0x1	ne_hstart1[7:0] (LSB) Prevent from hactive larger than 720 Choose the start point of one line Range 1~1920	

Register:: Noise Estimation hactive start point (MSB)					0xB0
Name	Bits	Read/Write	Reset State	Comments	Config
reserved_dummy	7:3	R/W	0	reserved_dummy	
ne_hend1[10:8]	2:0	R/W	0x02	ne_hend1[10:8] (MSB) Prevent from hactive larger than 720 Choose the end point of one line Range 1~1920	

Register:: Horizontal active size (LSB)					0xB1
Name	Bits	Read/Write	Reset State	Comments	Config
ne_hend1[7:0]	7:0	R/W	0xd0	ne_hend1[7:0] (LSB) Prevent from hactive larger than 720 Choose the end point of one line Range 1~1920	

Register:: Noise Estimation hactive start point (MSB)					0xB2
Name	Bits	Read/Write	Reset State	Comments	Config
reserved_dummy	7:3	R/W	0	reserved_dummy	
ne_hstart2[10:8]	2:0	R/W	0x0	ne_hstart2[10:8] (MSB) Prevent from hactive larger than 720 Choose the start point of one line	

				Range 1~1920	
--	--	--	--	--------------	--

Register:: Horizontal active size (LSB)					0xB3
Name	Bits	Read/Write	Reset State	Comments	Config
ne_hstart2[7:0]	7:0	R/W	0x1	ne_hstart2[7:0] (LSB) Prevent from hactive larger than 720 Choose the start point of one line Range 1~1920	

Register:: Noise Estimation hactive start point (MSB)					0xB4
Name	Bits	Read/Write	Reset State	Comments	Config
reserved_dummy	7:3	R/W	0	reserved_dummy	
ne_hend2[10:8]	2:0	R/W	0x02	ne_hend2[10:8] (MSB) Prevent from hactive larger than 720 Choose the end point of one line Range 1~1920	

Register:: Horizontal active size (LSB)					0xB5
Name	Bits	Read/Write	Reset State	Comments	Config
ne_hend2[7:0]	7:0	R/W	0xd0	ne_hend2[7:0] (LSB) Prevent from hactive larger than 720 Choose the end point of one line Range 1~1920	

Register:: Noise Estimation hactive start point (MSB)					0xB6
Name	Bits	Read/Write	Reset State	Comments	Config
reserved_dummy	7:3	R/W	0	reserved_dummy	
ne_hstart3[10:8]	2:0	R/W	0x0	ne_hstart3[10:8] (MSB) Prevent from hactive larger than 720 Choose the start point of one line Range 1~1920	

Register:: Horizontal active size (LSB)					0xB7
Name	Bits	Read/Write	Reset State	Comments	Config
ne_hstart3[7:0]	7:0	R/W	0x1	ne_hstart3[7:0] (LSB) Prevent from hactive larger than 720 Choose the start point of one line Range 1~1920	

Register:: Noise Estimation hactive start point (MSB)					0xB8
Name	Bits	Read/Write	Reset State	Comments	Config
reserved_dummy	7:3	R/W	0	reserved_dummy	
ne_hend3[10:8]	2:0	R/W	0x02	ne_hend3[10:8] (MSB) Prevent from hactive larger than 720 Choose the end point of one line Range 1~1920	

Register:: Horizontal active size (LSB)					0xB9
---	--	--	--	--	------

Name	Bits	Read/Write	Reset State	Comments	Config
ne_hend3[7:0]	7:0	R/W	0xd0	ne_hend3[7:0] (LSB) Prevent from hactive larger than 720 Choose the end point of one line Range 1~1920	

Note : (ne_start – ne_end + 1) should be an **Even** Number and had better more than **128**.

Register:: Min Spatial Noise Value Within Bin1					0xBA
Name	Bits	Read/Write	Reset State	Comments	Config
status_noise_ns_bin1	7:0	R	0x0	Minimum Spatial Noise Value within Bin1	

Register:: Min Spatial Noise Value Within Bin2					0xBB
Name	Bits	Read/Write	Reset State	Comments	Config
status_noise_ns_bin2	7:0	R	0x0	Minimum Spatial Noise Value within Bin2	

Register:: Min Spatial Noise Value Within Bin3					0xBC
Name	Bits	Read/Write	Reset State	Comments	Config
status_noise_ns_bin3	7:0	R	0x0	Minimum Spatial Noise Value within Bin3	

Register:: Min Spatial Noise Value Within Bin4					0xBD
Name	Bits	Read/Write	Reset State	Comments	Config
status_noise_ns_bin4	7:0	R	0x0	Minimum Spatial Noise Value within Bin4	

Register:: Min Spatial Noise Value Within Bin5					0xBE
Name	Bits	Read/Write	Reset State	Comments	Config
status_noise_ns_bin5	7:0	R	0x0	Minimum Spatial Noise Value within Bin5	

Register:: Min Spatial Noise Value Within Bin6					0xBF
Name	Bits	Read/Write	Reset State	Comments	Config
status_noise_ns_bin6	7:0	R	0x0	Minimum Spatial Noise Value within Bin6	

Register:: Min Spatial Noise Value Within Bin7					0xC0
Name	Bits	Read/Write	Reset State	Comments	Config
status_noise_ns_bin7	7:0	R	0x0	Minimum Spatial Noise Value within Bin7	

Address 0xC0~0xD3 are reserved

Peaking and Coring and EMF/ Chroma Lowpass(Page 6)

Register:: Peaking_Enable					0xC1
Name	Bits	Read/Write	Reset State	Comments	Config
reserved_dummy	7:4	R/W	0x0	reserved_dummy	

pkcr_en_syn	3	R/W	0x0	Peaking and Coring Enable 0: Disable 1: Enable Valid Range: 0~1, Default Value: 0	
emf_en	2	R/W	0x0	1D Extend Median Filter Enable (when Peaking_Enable=1) 0: Disable 1: Enable Valid Range: 0~1, Default Value: 0	
clp_en	1	R/W	0x0	Chroma lowpass enable 0: Disable 1: Enable Valid Range: 0~1, Default Value: 0	
444_422_en	0	R/W	0x0	Color Conversion 444 to 422 enable 0: Not Enable, 1: Enable	

Register:: PEAKING_DATA_00				0xC2	
Name	Bits	Read/Write	Reset State	Comments	Config
reserved_dummy	7:4	R/W	0	reserved_dummy	
pxl_sel	3:2	R/W	0	Peaking and Coring Horizontal Pixel Select 10 : 9 pixel $2*c[0]*Y[n] + c[1]*(Y[n-2] + Y[n-1] + Y[n+1] + Y[n+2]) + c[2]*(Y[n-4] + Y[n-3] + Y[n+3] + Y[n+4])$ 01 : 7 pixel $2*c[0]*Y[n] + c[1]*(Y[n-2] + Y[n-1] + Y[n+1] + Y[n+2]) + c[2]*(Y[n-3] + Y[n-2] + Y[n+2] + Y[n+3])$ 00 : 5 pixel $c[0]*Y[n] + c[1]*(Y[n-1] + Y[n+1]) + c[2]*(Y[n-2] + Y[n+2])$ Valid Range: 0~2, Default Value: 0	reg_vc_PC_H or_PxlSel
uv_mode	1	R/W	0	444 to 422 U and V type 0 : U0 V0 U2 V2 U4 V4 1 : U0 V1 U2 V3 U4 V5	
C0[8]	0	R/W	0	Horizontal Peaking Filter Coefficient C0 (MSB) (C0 : 0-512 unsigned) Valid Range: 0~512, Default Value: 0	reg_vc_PC_H or_Filter_C0

Register:: PEAKING_DATA_01				0xC3	
Name	Bits	Read/Write	Reset State	Comments	Config
C0[7:0]	7:0	R/W	0	Horizontal Peaking Filter Coefficient C0(LSB) (C0 : 0-512 unsigned) Valid Range: 0~512, Default Value: 0	reg_vc_PC_H or_Filter_C0

Register:: PEAKING_DATA_02				0xC4	
Name	Bits	Read/Write	Reset State	Comments	Config
C1	7:0	R/W	0	Horizontal Peaking Filter Coefficient C1 (C1 : -128~127 2's Complement) Valid Range: 0~255, Default Value: 0	reg_vc_PC_H or_Filter_C1

Register:: PEAKING_DATA_03				0xC5	
Name	Bits	Read/Write	Reset State	Comments	Config

		Write	State		
C2	7:0	R/W	0	Horizontal Peaking Filter Coefficient C2 (C2 : -128~127 2's Complement) Valid Range: 0~255, Default Value: 0	reg_vc_PC_H or_Filter_C2

Register:: PEAKING_DATA_04					0xC6
Name	Bits	Read/Write	Reset State	Comments	Config
Gain_Blr	7:0	R/W	0	Gain Value for Low-pass at Center Range in Peaking and Coring (Gain_Blr : 0/64~16/64) Valid Range: 0~255, Default Value: 0	reg_vc_PC_G ain_Blr

Register:: PEAKING_DATA_05					0xC7
Name	Bits	Read/Write	Reset State	Comments	Config
Gain_Pos	7:0	R/W	0	Gain Value for High-pass or Band-pass at Positive Range in Peaking and Coring (Gain_Pos : 0/64~255/64) Valid Range: 0~255, Default Value: 0	reg_vc_PC_G ain_Pos

Register:: PEAKING_DATA_06					0xC8
Name	Bits	Read/Write	Reset State	Comments	Config
Gain_Neg	7:0	R/W	0	Gain Value for High-pass or Band-pass at Negative Range in Peaking and Coring (Gain_Neg : 0/64~255/64) Valid Range: 0~255, Default Value: 0	reg_vc_PC_G ain_Neg

Register:: PEAKING_DATA_07					0xC9
Name	Bits	Read/Write	Reset State	Comments	Config
reserved_dummy	7:4	R/W	0	reserved_dummy	
HV_Pos[9:8]	3:2	R/W	0	High Byte[9:8] of Coring High Level of Positive Range for Peaking and Coring (HV_Pos : 0~1023) Valid Range: 0~3, Default Value: 0	reg_vc_PC_H V_Pos
HV_Neg[9:8]	1:0	R/W	0	High Byte[9:8] of Coring High Level of Negative Range for Peaking and Coring (HV_Neg : 0~1023) Valid Range: 0~3, Default Value: 0	reg_vc_PC_H V_Neg

Register:: PEAKING_DATA_08					0xCA
Name	Bits	Read/Write	Reset State	Comments	Config
HV_Pos[7:0]	7:0	R/W	0	Low Byte[7:0] of Coring High Level of Positive Range for Peaking and Coring (HV_Pos : 0~1023) Valid Range: 0~255, Default Value: 0	reg_vc_PC_H V_Pos

Register:: PEAKING_DATA_09					0xCB
Name	Bits	Read/Write	Reset State	Comments	Config
HV_Neg[7:0]	7:0	R/W	0	Low Byte[7:0] of Coring High Level of Negative Range for Peaking and Coring (HV_Neg : 0~1023) Valid Range: 0~255, Default Value: 0	reg_vc_PC_H V_Neg

Register:: PEAKING_DATA_0A					0xCC
Name	Bits	Read/Write	Reset State	Comments	Config

		Write	State		
LV	7:0	R/W	0	Coring Low Level for Peaking and Coring (LV : 0~255) Valid Range: 0~255, Default Value: 0	reg_vc_PC_LV

Register:: PEAKING_DATA_0B					0xCD
Name	Bits	Read/Write	Reset State	Comments	Config
reserved_dummy	7:3	R/W	0	reserved_dummy	
EMF_Shift	2:0	R/W	0	Delta Shift Bit of Extend Median Filter for Peaking and Coring (EMF_Shift : 0~7) Valid Range: 0~7, Default Value: 0	reg_vc_PC_EMF_Shift

Register:: CHROMA_LOWPASS					0xCE
Name	Bits	Read/Write	Reset State	Comments	Config
reserved_dummy	7:5	R/W	0	reserved_dummy	
Clp_blur	4:0	R/W	0	Blur Factor for Chrominance Factor. (Blur_Fac : 0~16) Valid Range: 0~31, Default Value: 0	reg_vc_CLP_Blur_Fac

YUV422 to YUV444 Conversion & 2to1 Setup (page 6)

Register:: (YUV422_to_YUV444 Control & CP_DebugMode)					0xD4
Name	Bits	Read/Write	Reset State	Comments	Config
TR422TO444_EN	7	R/W	0x0	Translate YUV422 to YUV444 Enable 0: Disable (Bypass YUV422 to YUV444 function) 1: Enable (Because SD/NR only support Format444, it is necessary to translate 422 to 444 before data going into SD/NR.)	
OUT444_FMT	6	R/W	0x0	Output 444 Format 0: $Y_0U_0V_0, Y_1\frac{(U_0+U_2)}{2}, \frac{(V_0+V_2)}{2}, Y_2U_2V_2, Y_3\frac{(U_2+U_4)}{2}, \frac{(V_2+V_4)}{2}, \dots$ 1: $Y_0U_0V_1, Y_1\frac{(U_0+U_2)}{2}, V_1, Y_2U_2\frac{(V_1+V_3)}{2}, Y_3\frac{(U_2+U_4)}{2}, V_3, \dots$	
UV_SWAP	5	R/W	0x0	UV Swap (for YUV422 to YUV444) 0: Sequence 444 result: Y, U, V 1: Sequence 444 result: Y, V, U	
Reserved	4:2	-	-	Reserved	
CP_DebugMode	1:0	R/W	0x0	Debug mode selection for CP. By the different color output, it could identify Y or Cb or Cr impulse noise. 0: Normal, 2: Impulse,	cc:reg_vc_nr_DebugMode

Register:: (Active Window Control_MSB for 2to1)					0xD5
Name	Bits	Read/Write	Reset State	Comments	Config
Reserved	7	-	-	Reserved	
HSize[10:8]	6:4	R/W	0x2	Input & Output Active Size Control hsize[10:8] Horizontal Active Window Size	

				(width)(most-significant byte). Default = 720 (dec)	
Reserved	3:2	-	-	Reserved	
HBlkSize[9:8]	1:0	R/W	0x0	Input & Output Active Size Control blanksize[9:8] Blanking Window Size (width) (least-significant byte). Default = 138 (dec)	

Register:: (Active Window Control_LSB for 2to1)					0xD6
Name	Bits	Read/ Write	Reset State	Comments	Config
HSize[7:0]	7:0	R/W	0xD0	Input & Output Active Size Control hsize[7:0] Horizontal Active Window Size (width) (least-significant byte). Default = 720 (dec)	

Register:: (Active Window Control_LSB for 2to1)					0xD7
Name	Bits	Read/ Write	Reset State	Comments	Config
HBlkSize[7:0]	7:0	R/W	0x8A	Input & Output Active Size Control blanksize[7:0] Blanking Window Size (width) (least-significant byte). Default = 138 (dec)	

DCTi (Dynamic Chromance Transition Improvement) in I-Domain(Page 6)

Register:: DCTi_1st_Gain					0xD8
Name	Bits	Read/ Write	Reset State	Comments	Config
En_DCTI	7	R/W	0x0	DCTI Enable 0: Disable 1: Enable (Even disable DCTI function, it still would delay 11 dummy cycles.)	
Prevent_PE	6	R/W	1	Prevent Phase Error Mode 0: Disable 1: Enable	
Reserved	5	R/W	0	Reserved	
Value	4:0	R/W	0A	Adjust DCTi 1 st Gain Value(5-bit) Valid Range: 0~31, Default Value: 10 (8-bit)	

Register:: DCTi_1st_Gain_Threshold					0xD9
Name	Bits	Read/ Write	Reset State	Comments	Config
Reserved	7:6	R/W	0	Reserved	
Value	5:0	R/W	1E	Up and Down Limit for DCTi_1st_Gain Result Value (6-bit) Valid Range: 0~64 (8-bit)	

Image Processor Performance (Noise Reduction in I-domain) Register Control(Page 6)

Clean Picture™ (Noise Reduction in I-domain) Overall Control

Register:: (CP_Ctrl)					0xDA
Name	Bits	Read/Write	Reset State	Comments	Config
CP_ImpulseWindow	7:6	R/W	0x0	00: 3x3 Window 01: 5x3 Window	cc:reg_vc_nr_ImpulseWindow
CP_IResultWeight	5:3	R/W	0x7	$I_{out} = I_{out} \times ((ImpulseResultWeight+1)/8) + T_{out} \times (1 - (ImpulseResultWeight+1)/8)$	cc:reg_vc_nr_ImpulseResultWeight
CP_SResultWeight	2:0	R/W	0x7	$S_{out} = R \times ((SpatialResultWeight+1)/8) + original \times (1 - (SpatialResultWeight+1)/8)$	cc:reg_vc_nr_SpatialResultWeight

Register:: (Spatial_Ctrl2)					0xDB
Name	Bits	Read/Write	Reset State	Comments	Config
Reserved	7	R/W	0x0	Reserved	
CP_ZoranFilterSize	6	R/W	0x0	0: 11 points Zoran Filter 1: 15 points Zoran Filter	cc:reg_vc_nr_ZoranFilterSize
Reserved	5:3	R/W	0x0	Reserved	
CP_SpatialEnable	2	R/W	0x1	0: Disable 1: Enable	cc:reg_vc_nr_SpatialEnable
CP_ImpulseEnable	1	R/W	0x1	0: Disable 1: Enable	cc:reg_vc_nr_ImpulseEnable
Reserved	0	R/W	0x0	Reserved	

Spatial noise reduction (Zoran Filter)

Register:: (Spatial_ThIY)					0xDC
Name	Bits	Read/Write	Reset State	Comments	Config
CP_SpatialThIY	7:0	R/W	0x3	Spatial threshold for luma. Larger value increases the opportunity to do spatial noise reduction.	cc:reg_vc_nr_SpatialWeightY

Register:: (Spatial_ThIC)					0xDD
Name	Bits	Read/Write	Reset State	Comments	Config
CP_SpatialThIC	7:0	R/W	0x3	Spatial threshold for chroma. Larger value increases the opportunity to do spatial noise reduction.	cc:reg_vc_nr_SpatialWeightC

Impulse noise reduction (Impulse Filter)

Register:: (Impulse_PixelDiffThI)					0xDE
Name	Bits	Read/Write	Reset State	Comments	Config
CP_IPixelDiffThIC	7:4	R/W	0x5	Larger value decreases the opportunity for judging the chroma value of a pixel as an impulse.	cc:reg_vc_nr_PixelDiffThIC
CP_IPixelDiffThIY	3:0	R/W	0xA	Larger value decreases the opportunity for judging the luma value of a pixel as an impulse.	cc:reg_vc_nr_PixelDiffThIY

Register:: (Impulse_ThIY)					0xDF
Name	Bits	Read/Write	Reset State	Comments	Config
CP_ImpulseThIY	7:0	R/W	0x28	Larger value decreases the opportunity for judging the luma value of a pixel as an impulse.	cc:reg_vc_nr_ImpulseThIY

Register:: (Impulse_ThIC)					0xE0
Name	Bits	Read/Write	Reset State	Comments	Config
CP_ImpulseThIC	7:0	R/W	0x1E	Larger value decreases the opportunity for judging the chroma value of a pixel as an impulse.	cc:reg_vc_nr_ImpulseThIC

Register:: (Impulse_SmoothThIY)					0xE1
Name	Bits	Read/Write	Reset State	Comments	Config
CP_ImpulseSmoothThIY	7:0	R/W	0xB	Larger value increases the opportunity for judging the luma value of a pixel as an impulse.	cc:reg_vc_nr_ImpulseSmoothThIY

Register:: (Impulse_SmoothThIC)					0xE2
Name	Bits	Read/Write	Reset State	Comments	Config
CP_ImpulseSmoothThIC	7:0	R/W	0x5	Larger value increases the opportunity for judging the chroma value of a pixel as an impulse.	cc:reg_vc_nr_ImpulseSmoothThIC

Scale Down(page 6)
Linear and Non-linear Scale Down

Register:: UZD_(CH2_)Ctrl0					0xE3
Name	Bits	Read/Write	Reset State	Comments	Config
VIDEO_COMP_EN	7	R/W	0	Video mode compensation 0: disable 1: enable	
ODD_INV	6	R/W	0	Internal ODD-signal inverse for	

				video-compensation 0: No invert 1: invert	
CHANNEL_YUV_RGB	5	R/W	0	At boundary, there is a filter window in Noise Reduction. It needs the default value to operate this filter window. If the data channel is YUV or RGB, the default value of beyond real image should be different. 0: YUV (black) (8bit Y:16,U:128,V:128) (10bit Y:64,U:512,V:512) 1: RGB (black) (R:0, G:0, B:0)	
SBUFF_EXT	4	R/W/D	0	Short Buffer Extension Mode(Become 1920 pixel wide, 2-tap) 0: disable 1: Enable	
V_TABLE_SEL	3	R/W/D	0	Select Vertical user defined filter coefficient table 0: 1 st Coefficient Table 1: 2 nd Coefficient Table	
H_TABLE_SEL	2	R/W/D	0	Select Horizontal user defined filter coefficient table 0: 1 st Coefficient Table 1: 2 nd Coefficient Table	
V_ZOOM_EN	1	R/W/D	0	Enable the Vertical Zoom Function 0: By pass the vertical zoom function block 1: Enable the vertical zoom function block	Cc: reg_vc_scal edown_v_z oom_en
H_ZOOM_EN	0	R/W/D	0	Enable the Horizontal Zoom Function 0: By pass the horizontal zoom function block 1: Enable the horizontal zoom function block	Cc: reg_vc_scal edown_h_z oom_en

Register:: UZD_(CH2_)Ctrl1					0xE4
Name	Bits	Read/Write	Reset State	Comments	Config
BIST_START	7	R/W	0	Line Buffer BIST Start Set 1 to start and auto-clear after finished	Reg Hw_clr
BIST_RESULT	6	R	0	Line Buffer BIST Result 0: Failed 1: Pass	
DB_APPLY	5	R/W	0	UZD double buffer ready 0: Not ready to apply 1: Ready to apply Registers marked “/D” in R/W field are double buffer registers. These registers will auto-load by input VS edge. CH1 is triggered by CH1 VS, CH2 is triggered by CH2 VS.	
DB_EN	4	R/W	0	UZD double buffer enable 0: Disable (Original- Write instantly by MCU write cycles) 1: Enable	
BUFFER_MODE	3:2	R/W/D	0	Buffer Mode Selection 00: Bypass (Not available for both NR and vertical UZD, Horizontal UZD is available) 01: For NR (vertical UZD is not available) 10: For vertical UZD, H->V (NR is not available)	Cc: reg_vc_scal edown_buff er_mode

				11: For vertical UZD, V->H (NR is not available)	
Rev	1:0	---	---	Reserved	

Register:: UZD_(CH2_)Scale_Hor_Factor_H					0xE5
Name	Bits	Read/Write	Reset State	Comments	Config
HOR_FAC[23:16]	7:0	R/W/D	0	Bit [23:16] of horizontal scale factor	Cc: reg_vc_scal edown_HSc aleFactor

Register:: UZD_(CH2_)Scale_Hor_Factor_M					0xE6
Name	Bits	Read/Write	Reset State	Comments	Config
HOR_FAC[15:8]	7:0	R/W/D	0	Bit [15:8] of horizontal scale factor	Cc: reg_vc_scal edown_HSc aleFactor

Register:: UZD_(CH2_)Scale_Hor_Factor_L					0xE7
Name	Bits	Read/Write	Reset State	Comments	Config
HOR_FAC[7:0]	7:0	R/W/D	0	Bit [7:0] of horizontal scale factor	Cc: reg_vc_scal edown_HSc aleFactor

Hor_Fac = Input_Width / Output_Width * 2²⁰

Register:: UZD_(CH2_)Scale_Ver_Factor_H					0xE8
Name	Bits	Read/Write	Reset State	Comments	Config
VER_FAC[23:16]	7:0	R/W/D	0	Bit [23:16] of vertical scale factor	Cc: reg_vc_scal edown_VSc aleFactor

Register:: UZD_(CH2_)Scale_Ver_Factor_M					0xE9
Name	Bits	Read/Write	Reset State	Comments	Config
VER_FAC[15:8]	7:0	R/W/D	0	Bit [15:8] of vertical scale factor	Cc: reg_vc_scal edown_VSc aleFactor

Register:: UZD_(CH2_)Scale_Ver_Factor_L					0xEA
Name	Bits	Read/Write	Reset State	Comments	Config
VER_FAC[7:0]	7:0	R/W/D	0	Bit [7:0] of vertical scale factor	Cc: reg_vc_scal edown_VSc aleFactor

$$\text{Ver_Fac} = \text{Input_Length} / \text{Output_Length} * 2^{20}$$

n Non-Linear Scaling

Register:: UZD_(CH2_)Hor_Delta1_H					0xEB
Name	Bits	Read/Write	Reset State	Comments	Config
NL_D1[13:6]	7:0	R/W/D	0	Bit [13:6] of Horizontal Non-Linear Delta1 (2's complement)	Cc: reg_vc_scaledown_HScaleDelta1

Register:: UZD_(CH2_)Hor_Delta1_L					0xEC
Name	Bits	Read/Write	Reset State	Comments	Config
NL_D1[5:0]	7:2	R/W/D	0	Bit [5:0] of Horizontal Non-Linear Delta1 (2's complement)	Cc: reg_vc_scaledown_HScaleDelta1
Reserved	1:0	-	-	Reserved	

$$\text{Bit}[13:0] = \text{Delta} * 2^{20}$$

UZD output size = SEG1 * 2 + SEG2, output size can not be 0.

Register:: UZD_(CH2_)Hor_Segment1_H					0xED
Name	Bits	Read/Write	Reset State	Comments	Config
Dummy	7:3	R/W	0x1E	Reserved	
NL_SEG1[10:8]	2:0	R/W/D	0	Bit [10:8] of Horizontal Non-Linear Segment1	Cc: reg_vc_scaledown_HScaleSegment1

Register:: UZD_(CH2_)Hor_Segment1_L					0xEE
Name	Bits	Read/Write	Reset State	Comments	Config
NL_SEG1[7:0]	7:0	R/W/D	0	Bit [7:0] of Horizontal Non-Linear Segment1	Cc: reg_vc_scaledown_HScaleSegment1

Register:: UZD_(CH2_)Hor_Segment2_H					0xEF
Name	Bits	Read/Write	Reset State	Comments	Config
Dummy	7:3	R/W	0x00	Reserved	
NL_SEG2[10:8]	2:0	R/W/D	0	Bit [10:8] of Horizontal Non-Linear Segment2	Cc: reg_vc_scaledown_HScaleSegment2

Register:: UZD_(CH2_)Hor_Segment2_L						0xF0
Name	Bits	Read/Write	Reset State	Comments	Config	
NL_SEG2[7:0]	7:0	R/W/D	0	Bit [7:0] of Horizontal Non-Linear Segment2	Cc: reg_vc_scaledown_HscaleSegment2	

Register:: UZD_(CH2_)Hor_Initial_Value						0xF1
Name	Bits	Read/Write	Reset State	Comments	Config	
HOR_INI	7:0	R/W	0	Horizontal Scaling Initial Value	Cc: reg_vc_scaledown_HInitValue	

Register:: UZD_(CH2_)Ver_Initial_Value						0xF2
Name	Bits	Read/Write	Reset State	Comments	Config	
VER_INI	7:0	R/W	0	Vertical Scaling Initial Value	Cc: reg_vc_scaledown_VInitValue	

n FIR Coef Ctrl

Register::UZD_FIR_Coeff_Index						0xF3
Name	Bits	Read/Write	Reset State	Comments	Config	
COEF_CH_SEL	7	R/W	0	Select H/V User Defined Filter Coefficient Table for Access Channel 0: 1 st Coefficient Table 1: 2 nd Coefficient Table	Cc:	
COEF_READ_EN	6	R/W	0	Coefficient Read from Coef_Port 0: Disable 1: Enable (Note: It will make FIR un-normal while reading coefficients.)		
COEF_CH_INDEX	5:0	R/W	0	Coefficient Access Port Index (0 ~ 63) 0: c0L; 1: c0H; 2: c1L; 3: c1H; ... 14: c7L; 15: c7H; 16: c16L; 17: c16H; 18: c17L; 19: c17H; ... 30: c23L; 31: c23H; 32: c31L; 33: c31H; 34: c30L; 35: c30H; ... 46: c24L; 47: c24H; 48: c15L; 49: c15H; 50: c14L; 51: c14H; ... 62: c8L; 63: c8H;	Cc:	

Register:: UZD_FIR_Coeff_Port						0xF4
Name	Bits	Read/Write	Reset State	Comments	Config	
COEF_PORT	7:0	R/W	0	Access port for user defined filter coefficient table	Cc:	

- I Since the 64 taps is symmetric, we need to fill the 32-coefficient sequence into table only. The sequence are c0~c7, c16~c23, c31~c24, c15~c8. Each coefficient spends 2 cycle(Low_Byte first and then High_Byte), totally 32 * 2 cycles.

Uzd_CRC_CTRL

Register:: Uzd_CRC_CTR				0xF5	
Name	Bits	Read/Write	Reset State	Comments	Config
reserved	7:2	-	-	Reserved	
conti	1	R/W	0	Continuously mode 0: one time mode(after finish, the bit "start" is set to 0.) 1: Continuous mode(double buffer)	
Start	0	R/W	0	CRC Control: 0: Stop or finish (Auto-stop after checked a completed display frame) 1: Start	Reg hw_clr

Register:: Uzd_CRC_HH				0xF6	
Name	Bits	Read/Write	Reset State	Comments	Config
Uzd_CRC[31:24]	7:0	R	0	CRC Result: CRC[31:24]	

Register:: Uzd_CRC_H				0xF7	
Name	Bits	Read/Write	Reset State	Comments	Config
Uzd_CRC[23:16]	7:0	R	0	CRC Result: CRC[23:16]	

Register:: Uzd_CRC_M				0xF8	
Name	Bits	Read/Write	Reset State	Comments	Config
Uzd_CRC[15:8]	7:0	R	0	CRC Result: CRC[15:8]	

Register:: Uzd_CRC_L				0xF9	
Name	Bits	Read/Write	Reset State	Comments	Config

UZD_CRC[7:0]	7:0	R	0	CRC Result: CRC[7:0]	
--------------	-----	---	---	----------------------	--

(total occupies 38 address)

Address 0xFA~0xFF are reserved

Vivid color-DLTi/DCTi(Page 7)

Register:: DLTi_DCTi Enable					0xA1
Name	Bits	Read/Write	Reset State	Comments	Config
Enabled	7	R/W	0	DLTi enable 0: Disable 1: Enable	
Enabled	6	R/W	0	DCTi enable 0: Disable 1: Enable	
	5:0	R/W	0	Dummy bits	

Register:: DLTi_HF_Threshold					0xA2
Name	Bits	Read/Write	Reset State	Comments	Config
Enabled	7	R/W	1	Check High Frequency Line Data for skip DLTi Process. 0: Disable 1: Enable	
Value	6:0	R/W	2A	Threshold Value for check high frequency data Valid Range: 0~128 (128+), Default Value: 42 (8-bit),	

Register:: DLTi_Gain					0xA3
Name	Bits	Read/Write	Reset State	Comments	Config
Dlti_dummy	7:4	R/W	0	Dummy bits	
Value	3:0	R/W	05	Adjust DLTi Gain Value(4-bit) Valid Range: 0~15 (8-bit)	

Register:: DLTi_Gain_Threshold					0xA4
Name	Bits	Read/Write	Reset State	Comments	Config
Dlti_dummy2	7:6	R/W	0	Dummy bits	
Value	5:0	R/W	1E	Up and Down Limit for DLTi_Gain Result Value (6-bit) Valid Range: 0~64 (8-bit),	

Register:: DLTi_Options					0xA5
Name	Bits	Read/Write	Reset State	Comments	Config

Advance_Delay	7	R/W	0	Advance Delay Points 0: Disable 1: Enable	
Prevent_Long	6	R/W	1	Prevent Edge on Long distances 0: Disable 1: Enable	
Prevent_Near	5	R/W	1	Prevent 2 points too close. 0: Disable 1: Enable	
Prevent_Contour	4	R/W	1	Prevent contour 0: Disable 1: Enable	
Prevent_Contour_Th	3:0	R/W	6	Prevent contour threshold (4-bit) Valid Range: 0~15, Default Value: 6 (8-bit), 24 (10-bit)	

Register:: DCTi_1st_Gain					0xA6
Name	Bits	Read/Write	Reset State	Comments	Config
Prevent_PE	7	R/W	1	Prevent Phase Error Mode 0: Disable 1: Enable	
Dummy	6:5	R/W	0	Reserved	
Value	4:0	R/W	0A	Adjust DCTi 1 st Gain Value(5-bit) Valid Range: 0~31, Default Value: 10 (8-bit)	

Register:: DCTi_1st_Gain_Threshold					0xA7
Name	Bits	Read/Write	Reset State	Comments	Config
Dummy2	7:6	R/W	0	Reserved	
Value	5:0	R/W	1E	Up and Down Limit for DCTi_1st_Gain Result Value (6-bit) Valid Range: 0~64 (8-bit)	

Address 0xA8 is reserved

Peaking and Coring and EMF/ Chroma Lowpass(page 7)

Register::					0xA9
Name	Bits	Read/Write	Reset State	Comments	Config
reserved_dummy_b0_7_4	7:4	R/W	0x0	reserved_dummy	
pkcr_en_syn	3	R/W	0x0	Peaking and Coring Enable 0: Disable 1: Enable Valid Range: 0~1, Default Value: 0	
emf_en	2	R/W	0x0	ID Extend Median Filter Enable (when Peaking_Enable=1) 0: Disable 1: Enable Valid Range: 0~1, Default Value: 0	
clp_en	1	R/W	0x0	Chroma lowpass enable 0: Disable 1: Enable Valid Range: 0~1, Default Value: 0	
	0	R/W	0x0	Reserved	

Register::					0xAA
Name	Bits	Read/Write	Reset State	Comments	Config
reserved_dummy_b1_7_4	7:4	R/W	0x0	reserved_dummy	
pxl_sel	3:2	R/W	0	Peaking and Coring Horizontal Pixel Select 10 : 9 pixel $2*c[0]*Y[n] + c[1]*(Y[n-2] + Y[n-1] + Y[n+1] + Y[n+2]) + c[2]*(Y[n-4] + Y[n-3] + Y[n+3] + Y[n+4])$ 01 : 7 pixel $2*c[0]*Y[n] + c[1]*(Y[n-2] + Y[n-1] + Y[n+1] + Y[n+2]) + c[2]*(Y[n-3] + Y[n-2] + Y[n+2] + Y[n+3])$ 00 : 5 pixel $c[0]*Y[n] + c[1]*(Y[n-1] + Y[n+1]) + c[2]*(Y[n-2] + Y[n+2])$ Valid Range: 0~2, Default Value: 0	
	1	R/W	0x0	Reserved	
C0[8]	0	R/W	0	Horizontal Peaking Filter Coefficient C0 (MSB) (C0 : 0-512 unsigned) Valid Range: 0~512, Default Value: 0	

Register::					0xAB
Name	Bits	Read/Write	Reset State	Comments	Config
C0[7:0]	7:0	R/W	0	Horizontal Peaking Filter Coefficient C0(LSB) (C0 : 0-512 unsigned) Valid Range: 0~512, Default Value: 0	

Register::					0xAC
Name	Bits	Read/Write	Reset State	Comments	Config
C1	7:0	R/W	0	Horizontal Peaking Filter Coefficient C1 (C1 : -128~127 2's Complement) Valid Range: 0~255, Default Value: 0	

Register::					0xAD
Name	Bits	Read/Write	Reset State	Comments	Config
C2	7:0	R/W	0	Horizontal Peaking Filter Coefficient C2 (C2 : -128~127 2's Complement) Valid Range: 0~255, Default Value: 0	

Register::					0xAE
Name	Bits	Read/Write	Reset State	Comments	Config
Gain_Blr	7:0	R/W	0	Gain Value for Low-pass at Center Range in Peaking and Coring (Gain_Blr : 0/64~16/64) Valid Range: 0~255, Default Value: 0	

Register::					0xAF
Name	Bits	Read/	Reset	Comments	Config

Gain_Pos	7:0	Write R/W	State 0	Gain Value for High-pass or Band-pass at Positive Range in Peaking and Coring (Gain_Pos : 0/64~255/64) Valid Range: 0~255, Default Value: 0
----------	-----	--------------	------------	--

Register::					0Xb0
Name	Bits	Read/Write	Reset State	Comments	Config
Gain_Neg	7:0	R/W	0	Gain Value for High-pass or Band-pass at Negative Range in Peaking and Coring (Gain_Neg : 0/64~255/64) Valid Range: 0~255, Default Value: 0	

Register::					0xb1
Name	Bits	Read/Write	Reset State	Comments	Config
reserved_dummy_b8_7_4	7:4	R/W	0	reserved_dummy	
HV_Pos[9:8]	3:2	R/W	0	High Byte[9:8] of Coring High Level of Positive Range for Peaking and Coring (HV_Pos : 0~1023) Valid Range: 0~3, Default Value: 0	
HV_Neg[9:8]	1:0	R/W	0	High Byte[9:8] of Coring High Level of Negative Range for Peaking and Coring (HV_Neg : 0~1023) Valid Range: 0~3, Default Value: 0	

Register::					0xb2
Name	Bits	Read/Write	Reset State	Comments	Config
HV_Pos[7:0]	7:0	R/W	0	Low Byte[7:0] of Coring High Level of Positive Range for Peaking and Coring (HV_Pos : 0~1023) Valid Range: 0~255, Default Value: 0	

Register::					0Xb3
Name	Bits	Read/Write	Reset State	Comments	Config
HV_Neg[7:0]	7:0	R/W	0	Low Byte[7:0] of Coring High Level of Negative Range for Peaking and Coring (HV_Neg : 0~1023) Valid Range: 0~255, Default Value: 0	

Register::					0xb4
Name	Bits	Read/Write	Reset State	Comments	Config
LV	7:0	R/W	0	Coring Low Level for Peaking and Coring (LV : 0~255) Valid Range: 0~255, Default Value: 0	

Register::					0xb5
Name	Bits	Read/Write	Reset State	Comments	Config
reserved_dummy_b_c_7_3	7:3	R/W	0	reserved_dummy	

EMF_Shift	2:0	R/W	0	Delta Shift Bit of Extend Median Filter for Peaking and Coring (EMF_Shift : 0~7) Valid Range: 0~7, Default Value: 0	
-----------	-----	-----	---	---	--

Register::					0xb6
Name	Bits	Read/Write	Reset State	Comments	Config
Reserved	7:5	--	0	Reserved	
Clp_blur	4:0	R/W	0	Blur Factor for Chrominance Factor. (Blur_Fac : 0~16) Valid Range: 0~31, Default Value: 0	

AUTO SHARPNESS (Page 7)

Register:: AUTO_SHP_CTRL					0xB7
Name	Bits	Read/Write	Reset State	Comments	Config
Reserved	7:1	--	0	Reserved	
Reserved	1	--	0	Reserved	
Enable	0	R/W	0	Auto Sharpness Enable (It will be auto cleared after one frame summation done) 0 : Disable 1 : Enable Valid Range: 0~1, Default Value: 0	reg_vc_Auto_Shp_Enable

Register:: AUTO_SHP_ADDR					0xB8
Name	Bits	Read/Write	Reset State	Comments	Config
VALUE	7:0	R/W	0	Noise Reduction and Sharpness port address AUTO_SHP_ADDR will be increased automatically after each byte of AUTO_SHP_DATA has been accessed. Valid Range: 0~255, Default Value: 0	

Register:: AUTO_SHP_DATA					0xB9
Name	Bits	Read/Write	Reset State	Comments	Config
Shp_data	7:0	R/W	0	DATA	

Register::AUTO_SHP_DATA_00					0xb900
Name	Bits	Read/Write	Reset State	Comments	Config
Y_LB	7:0	R/W	0	Auto Sharpness Y Range Lower Bound (Y_LB : 0*2~255*2) Valid Range: 0~255, Default Value: 0	reg_vc_Auto_Shp_Y_LB

Register::AUTO_SHP_DATA_01					0xb901
Name	Bits	Read/Write	Reset State	Comments	Config

		Write	State		
Y_UB	7:0	R/W	0	Auto Sharpness Y Range Upper Bound (Y_UB : 0*2+513~255*2+513) Valid Range: 0~255, Default Value: 0	reg_vc_Auto_Shp_Y_HB

Register::AUTO_SHP_DATA_02					0xb902
Name	Bits	Read/Write	Reset State	Comments	Config
Reserved	7:4	--	0	Reserved	
Shift_Bit	3:0	R/W	0	Auto Sharpness FIR Data Shift Right Bits. (Shift_Bit : 0~15) Valid Range: 0~15, Default Value: 0	reg_vc_Auto_Shp_FIR_Shift

Register::AUTO_SHP_DATA_03					0xb903
Name	Bits	Read/Write	Reset State	Comments	Config
BIN0_Offset	7:0	R/W	0	Auto Sharpness Bin[0] Offset (BIN0_Offset : 0~255) Valid Range: 0~255, Default Value: 0	reg_vc_Auto_Shp_Bin0_Offset

Register:: AUTO_SHP_FIR_COUNT_00					0xb904
Name	Bits	Read/Write	Reset State	Comments	Config
Reserved	7:5	--	0	Reserved	
LUT0_2	4:0	R	0	Byte [20:16] of FIR_Count[0]. (FIR_Count[0] : 0~1920*1080) Valid Range: 0~31, Default Value: 0	reg_vc_Auto_Shp_FIR_Count_00

Register:: AUTO_SHP_FIR_COUNT_01					0xb905
Name	Bits	Read/Write	Reset State	Comments	Config
LUT0_1	7:0	R	0	Byte [15:8] of FIR_Count[0]. (FIR_Count[0] : 0~1920*1080) Valid Range: 0~255, Default Value: 0	reg_vc_Auto_Shp_FIR_Count_00

Register:: AUTO_SHP_FIR_COUNT_02					0xb906
Name	Bits	Read/Write	Reset State	Comments	Config
LUT0_0	7:0	R	0	Byte [7:0] of FIR_Count[0]. (FIR_Count[0] : 0~1920*1080) Valid Range: 0~255, Default Value: 0	reg_vc_Auto_Shp_FIR_Count_00

Register:: AUTO_SHP_FIR_COUNT_03					0xb907
Name	Bits	Read/Write	Reset State	Comments	Config
Reserved	7:5	--	0	Reserved	
LUT1_2	4:0	R	0	Byte [20:16] of FIR_Count[1]. (FIR_Count[1] : 0~1920*1080) Valid Range: 0~31, Default Value: 0	reg_vc_Auto_Shp_FIR_Count_01

Register:: AUTO_SHP_FIR_COUNT_04					0xb908
Name	Bits	Read/	Reset	Comments	Config

Name	Bits	Write	State	Comments	Config
LUT1_1	7:0	R	0	Byte [15:8] of FIR_Count[1]. (FIR_Count[1] : 0~1920*1080) Valid Range: 0~255, Default Value: 0	reg_vc_Auto_Shp_FIR_Count_01

Register:: AUTO_SHP_FIR_COUNT_05 0xb909

Name	Bits	Read/Write	Reset State	Comments	Config
LUT1_0	7:0	R	0	Byte [7:0] of FIR_Count[1]. (FIR_Count[1] : 0~1920*1080) Valid Range: 0~255, Default Value: 0	reg_vc_Auto_Shp_FIR_Count_01

Register:: AUTO_SHP_FIR_COUNT_06 0xb90A

Name	Bits	Read/Write	Reset State	Comments	Config
Reserved	7:5	--	0	Reserved	
LUT2_2	4:0	R	0	Byte [20:16] of FIR_Count[2]. (FIR_Count[2] : 0~1920*1080) Valid Range: 0~31, Default Value: 0	reg_vc_Auto_Shp_FIR_Count_02

Register:: AUTO_SHP_FIR_COUNT_07 0xb90B

Name	Bits	Read/Write	Reset State	Comments	Config
LUT2_1	7:0	R	0	Byte [15:8] of FIR_Count[2]. (FIR_Count[2] : 0~1920*1080) Valid Range: 0~255, Default Value: 0	reg_vc_Auto_Shp_FIR_Count_02

Register:: AUTO_SHP_FIR_COUNT_08 0xb90C

Name	Bits	Read/Write	Reset State	Comments	Config
LUT2_0	7:0	R	0	Byte [7:0] of FIR_Count[2]. (FIR_Count[2] : 0~1920*1080) Valid Range: 0~255, Default Value: 0	reg_vc_Auto_Shp_FIR_Count_02

Register:: AUTO_SHP_FIR_COUNT_09 0xb90D

Name	Bits	Read/Write	Reset State	Comments	Config
Reserved	7:5	--	0	Reserved	
LUT3_2	4:0	R	0	Byte [20:16] of FIR_Count[3]. (FIR_Count[3] : 0~1920*1080) Valid Range: 0~31, Default Value: 0	reg_vc_Auto_Shp_FIR_Count_03

Register:: AUTO_SHP_FIR_COUNT_0A 0xb90E

Name	Bits	Read/Write	Reset State	Comments	Config
LUT3_1	7:0	R	0	Byte [15:8] of FIR_Count[3]. (FIR_Count[3] : 0~1920*1080) Valid Range: 0~255, Default Value: 0	reg_vc_Auto_Shp_FIR_Count_03

Register:: AUTO_SHP_FIR_COUNT_0B 0xb90F

Name	Bits	Read/Write	Reset State	Comments	Config
LUT3_0	7:0	R	0	Byte [7:0] of FIR_Count[3]. (FIR_Count[3] : 0~1920*1080)	reg_vc_Auto_Shp_FIR_Count_03

				Valid Range: 0~255, Default Value: 0	unt_03
--	--	--	--	--------------------------------------	--------

Register:: AUTO_SHP_FIR_COUNT_0C					0xb910
Name	Bits	Read/Write	Reset State	Comments	Config
Reserved	7:5	--	0	Reserved	
LUT4_2	4:0	R	0	Byte [20:16] of FIR_Count[4]. (FIR_Count[4] : 0~1920*1080) Valid Range: 0~31, Default Value: 0	reg_vc_Auto_Shp_FIR_Count_04

Register:: AUTO_SHP_FIR_COUNT_0D					0xb911
Name	Bits	Read/Write	Reset State	Comments	Config
LUT4_1	7:0	R	0	Byte [15:8] of FIR_Count[4]. (FIR_Count[4] : 0~1920*1080) Valid Range: 0~255, Default Value: 0	reg_vc_Auto_Shp_FIR_Count_04

Register:: AUTO_SHP_FIR_COUNT_0E					0xb912
Name	Bits	Read/Write	Reset State	Comments	Config
LUT4_0	7:0	R	0	Byte [7:0] of FIR_Count[4]. (FIR_Count[4] : 0~1920*1080) Valid Range: 0~255, Default Value: 0	reg_vc_Auto_Shp_FIR_Count_04

Register:: AUTO_SHP_FIR_COUNT_0F					0xb913
Name	Bits	Read/Write	Reset State	Comments	Config
Reserved	7:5	--	0	Reserved	
LUT5_2	4:0	R	0	Byte [20:16] of FIR_Count[5]. (FIR_Count[5] : 0~1920*1080) Valid Range: 0~31, Default Value: 0	reg_vc_Auto_Shp_FIR_Count_05

Register:: AUTO_SHP_FIR_COUNT_10					0xb914
Name	Bits	Read/Write	Reset State	Comments	Config
LUT5_1	7:0	R	0	Byte [15:8] of FIR_Count[5]. (FIR_Count[5] : 0~1920*1080) Valid Range: 0~255, Default Value: 0	reg_vc_Auto_Shp_FIR_Count_05

Register:: AUTO_SHP_FIR_COUNT_11					0xb915
Name	Bits	Read/Write	Reset State	Comments	Config
LUT5_0	7:0	R	0	Byte [7:0] of FIR_Count[5]. (FIR_Count[5] : 0~1920*1080) Valid Range: 0~255, Default Value: 0	reg_vc_Auto_Shp_FIR_Count_05

Register:: AUTO_SHP_FIR_COUNT_12					0xb916
Name	Bits	Read/Write	Reset State	Comments	Config
Reserved	7:5	--	0	Reserved	
LUT6_2	4:0	R	0	Byte [20:16] of FIR_Count[6]. (FIR_Count[6] : 0~1920*1080) Valid Range: 0~31, Default Value: 0	reg_vc_Auto_Shp_FIR_Count_06

Register:: AUTO_SHP_FIR_COUNT_13					0xb917
Name	Bits	Read/Write	Reset State	Comments	Config
LUT6_1	7:0	R	0	Byte [15:8] of FIR_Count[6]. (FIR_Count[6] : 0~1920*1080) Valid Range: 0~255, Default Value: 0	reg_vc_Auto_Shp_FIR_Count_06

Register:: AUTO_SHP_FIR_COUNT_14					0xb918
Name	Bits	Read/Write	Reset State	Comments	Config
LUT6_0	7:0	R	0	Byte [7:0] of FIR_Count[6]. (FIR_Count[6] : 0~1920*1080) Valid Range: 0~255, Default Value: 0	reg_vc_Auto_Shp_FIR_Count_06

Register:: AUTO_SHP_FIR_COUNT_15					0xb919
Name	Bits	Read/Write	Reset State	Comments	Config
Reserved	7:5	--	0	Reserved	
LUT7_2	4:0	R	0	Byte [20:16] of FIR_Count[7]. (FIR_Count[7] : 0~1920*1080) Valid Range: 0~31, Default Value: 0	reg_vc_Auto_Shp_FIR_Count_07

Register:: AUTO_SHP_FIR_COUNT_16					0xb91A
Name	Bits	Read/Write	Reset State	Comments	Config
LUT7_1	7:0	R	0	Byte [15:8] of FIR_Count[7]. (FIR_Count[7] : 0~1920*1080) Valid Range: 0~255, Default Value: 0	reg_vc_Auto_Shp_FIR_Count_07

Register:: AUTO_SHP_FIR_COUNT_17					0xb91B
Name	Bits	Read/Write	Reset State	Comments	Config
LUT7_0	7:0	R	0	Byte [7:0] of FIR_Count[7]. (FIR_Count[7] : 0~1920*1080) Valid Range: 0~255, Default Value: 0	reg_vc_Auto_Shp_FIR_Count_07

Register:: AUTO_SHP_FIR_COUNT_18					0xb91C
Name	Bits	Read/Write	Reset State	Comments	Config
Reserved	7:5	--	0	Reserved	
LUT8_2	4:0	R	0	Byte [20:16] of FIR_Count[8]. (FIR_Count[8] : 0~1920*1080) Valid Range: 0~31, Default Value: 0	reg_vc_Auto_Shp_FIR_Count_08

Register:: AUTO_SHP_FIR_COUNT_19					0xb91D
Name	Bits	Read/Write	Reset State	Comments	Config
LUT8_1	7:0	R	0	Byte [15:8] of FIR_Count[8]. (FIR_Count[8] : 0~1920*1080) Valid Range: 0~255, Default Value: 0	reg_vc_Auto_Shp_FIR_Count_08

Register:: AUTO_SHP_FIR_COUNT_1A					0xb91E
Name	Bits	Read/Write	Reset State	Comments	Config

LUT8_0	7:0	R	0	Byte [7:0] of FIR_Count[8]. (FIR_Count[8] : 0~1920*1080) Valid Range: 0~255, Default Value: 0	reg_vc_Auto_Shp_FIR_Count_08
--------	-----	---	---	---	------------------------------

Register:: AUTO_SHP_FIR_COUNT_1B					0xb91F
Name	Bits	Read/Write	Reset State	Comments	Config
Reserved	7:5	--	0	Reserved	
LUT9_2	4:0	R	0	Byte [20:16] of FIR_Count[9]. (FIR_Count[9] : 0~1920*1080) Valid Range: 0~31, Default Value: 0	reg_vc_Auto_Shp_FIR_Count_09

Register:: AUTO_SHP_FIR_COUNT_1C					0xb920
Name	Bits	Read/Write	Reset State	Comments	Config
LUT9_1	7:0	R	0	Byte [15:8] of FIR_Count[9]. (FIR_Count[9] : 0~1920*1080) Valid Range: 0~255, Default Value: 0	reg_vc_Auto_Shp_FIR_Count_09

Register:: AUTO_SHP_FIR_COUNT_1D					0xb921
Name	Bits	Read/Write	Reset State	Comments	Config
LUT9_0	7:0	R	0	Byte [7:0] of FIR_Count[9]. (FIR_Count[9] : 0~1920*1080) Valid Range: 0~255, Default Value: 0	reg_vc_Auto_Shp_FIR_Count_09

Register:: AUTO_SHP_FIR_COUNT_1E					0xb922
Name	Bits	Read/Write	Reset State	Comments	Config
Reserved	7:5	--	0	Reserved	
LUT10_2	4:0	R	0	Byte [20:16] of FIR_Count[10]. (FIR_Count[10] : 0~1920*1080) Valid Range: 0~31, Default Value: 0	reg_vc_Auto_Shp_FIR_Count_10

Register:: AUTO_SHP_FIR_COUNT_1F					0xb923
Name	Bits	Read/Write	Reset State	Comments	Config
LUT10_1	7:0	R	0	Byte [15:8] of FIR_Count[10]. (FIR_Count[10] : 0~1920*1080) Valid Range: 0~255, Default Value: 0	reg_vc_Auto_Shp_FIR_Count_10

Register:: AUTO_SHP_FIR_COUNT_20					0xb924
Name	Bits	Read/Write	Reset State	Comments	Config
LUT10_0	7:0	R	0	Byte [7:0] of FIR_Count[10]. (FIR_Count[10] : 0~1920*1080) Valid Range: 0~255, Default Value: 0	reg_vc_Auto_Shp_FIR_Count_10

Register:: AUTO_SHP_FIR_COUNT_21					0xb925
Name	Bits	Read/Write	Reset State	Comments	Config
Reserved	7:5	--	0	Reserved	
LUT11_2	4:0	R	0	Byte [20:16] of FIR_Count[11].	reg_vc_Auto_

				(FIR_Count[11] : 0~1920*1080) Valid Range: 0~31, Default Value: 0	Shp_FIR_Count_11
--	--	--	--	--	------------------

Register:: AUTO_SHP_FIR_COUNT_22				0xb926	
---	--	--	--	---------------	--

Name	Bits	Read/Write	Reset State	Comments	Config
LUT11_1	7:0	R	0	Byte [15:8] of FIR_Count[11]. (FIR_Count[11] : 0~1920*1080) Valid Range: 0~255, Default Value: 0	reg_vc_Auto_Shp_FIR_Count_11

Register:: AUTO_SHP_FIR_COUNT_23				0xb927	
---	--	--	--	---------------	--

Name	Bits	Read/Write	Reset State	Comments	Config
LUT11_0	7:0	R	0	Byte [7:0] of FIR_Count[11]. (FIR_Count[11] : 0~1920*1080) Valid Range: 0~255, Default Value: 0	reg_vc_Auto_Shp_FIR_Count_11

Register:: AUTO_SHP_FIR_COUNT_24				0xb928	
---	--	--	--	---------------	--

Name	Bits	Read/Write	Reset State	Comments	Config
Reserved	7:5	--	0	Reserved	
LUT12_2	4:0	R	0	Byte [20:16] of FIR_Count[12]. (FIR_Count[12] : 0~1920*1080) Valid Range: 0~31, Default Value: 0	reg_vc_Auto_Shp_FIR_Count_12

Register:: AUTO_SHP_FIR_COUNT_25				0xb929	
---	--	--	--	---------------	--

Name	Bits	Read/Write	Reset State	Comments	Config
LUT12_1	7:0	R	0	Byte [15:8] of FIR_Count[12]. (FIR_Count[12] : 0~1920*1080) Valid Range: 0~255, Default Value: 0	reg_vc_Auto_Shp_FIR_Count_12

Register:: AUTO_SHP_FIR_COUNT_26				0xb92A	
---	--	--	--	---------------	--

Name	Bits	Read/Write	Reset State	Comments	Config
LUT12_0	7:0	R	0	Byte [7:0] of FIR_Count[12]. (FIR_Count[12] : 0~1920*1080) Valid Range: 0~255, Default Value: 0	reg_vc_Auto_Shp_FIR_Count_12

Register:: AUTO_SHP_FIR_COUNT_27				0xb92B	
---	--	--	--	---------------	--

Name	Bits	Read/Write	Reset State	Comments	Config
Reserved	7:5	--	0	Reserved	
LUT13_2	4:0	R	0	Byte [20:16] of FIR_Count[13]. (FIR_Count[13]. : 0~1920*1080) Valid Range: 0~31, Default Value: 0	reg_vc_Auto_Shp_FIR_Count_13

Register:: AUTO_SHP_FIR_COUNT_28				0xb92C	
---	--	--	--	---------------	--

Name	Bits	Read/Write	Reset State	Comments	Config
LUT13_1	7:0	R	0	Byte [15:8] of FIR_Count[13]. (FIR_Count[13]. : 0~1920*1080) Valid Range: 0~255, Default Value: 0	reg_vc_Auto_Shp_FIR_Count_13

Register:: AUTO_SHP_FIR_COUNT_29					0xb92D
Name	Bits	Read/Write	Reset State	Comments	Config
LUT13_0	7:0	R	0	Byte [7:0] of FIR_Count[13]. (FIR_Count[13] : 0~1920*1080) Valid Range: 0~255, Default Value: 0	reg_vc_Auto_Shp_FIR_Count_13

Register:: AUTO_SHP_FIR_COUNT_2A					0xb92E
Name	Bits	Read/Write	Reset State	Comments	Config
Reserved	7:5	--	0	Reserved	
LUT14_2	4:0	R	0	Byte [20:16] of FIR_Count[14]. (FIR_Count[14] : 0~1920*1080) Valid Range: 0~31, Default Value: 0	reg_vc_Auto_Shp_FIR_Count_14

Register:: AUTO_SHP_FIR_COUNT_2B					0xb92F
Name	Bits	Read/Write	Reset State	Comments	Config
LUT14_1	7:0	R	0	Byte [15:8] of FIR_Count[14]. (FIR_Count[14] : 0~1920*1080) Valid Range: 0~255, Default Value: 0	reg_vc_Auto_Shp_FIR_Count_14

Register:: AUTO_SHP_FIR_COUNT_2C					0xb930
Name	Bits	Read/Write	Reset State	Comments	Config
LUT14_0	7:0	R	0	Byte [7:0] of FIR_Count[14]. (FIR_Count[14] : 0~1920*1080) Valid Range: 0~255, Default Value: 0	reg_vc_Auto_Shp_FIR_Count_14

Register:: AUTO_SHP_FIR_COUNT_2D					0xb931
Name	Bits	Read/Write	Reset State	Comments	Config
Reserved	7:5	--	0	Reserved	
LUT15_2	4:0	R	0	Byte [20:16] of FIR_Count[15]. (FIR_Count[15] : 0~1920*1080) Valid Range: 0~31, Default Value: 0	reg_vc_Auto_Shp_FIR_Count_15

Register:: AUTO_SHP_FIR_COUNT_2E					0xb932
Name	Bits	Read/Write	Reset State	Comments	Config
LUT15_1	7:0	R	0	Byte [15:8] of FIR_Count[15]. (FIR_Count[15] : 0~1920*1080) Valid Range: 0~255, Default Value: 0	reg_vc_Auto_Shp_FIR_Count_15

Register:: AUTO_SHP_FIR_COUNT_2F					0xb933
Name	Bits	Read/Write	Reset State	Comments	Config
LUT15_0	7:0	R	0	Byte [7:0] of FIR_Count[15]. (FIR_Count[15] : 0~1920*1080) Valid Range: 0~255, Default Value: 0	reg_vc_Auto_Shp_FIR_Count_15

Address 0xBA~0xBE are reserved

Vivid color-Video Color Space Conversion(page 7)

Register:: YUV2RGB_CTRL					0xbf
Name	Bits	Read/Write	Reset State	Comments	Config
Dummy	7:2	R/W	0	Reserved	
Access	1	R/W	0	Enable YUV/RGB coefficient Access 0: Disable 1: Enable	
Enable	0	R/W	0	Enable YUV to RGB Conversion 0: Disable YUV-to-RGB conversion 1: Enable YUV-to-RGB conversion	

Register:: YUV2RGB_ACCESS					0xc0
Name	Bits	Read/Write	Reset State	Comments	Config
Write_Enabled	7:4	R/W	0	YUV Coefficient Write Enable: 0000: K11 high byte 0001: K11 low byte 0010: K13 high byte 0011: K13 low byte 0100: K22 high byte 0101: K22 low byte 0110: K23 high byte 0111: K23 low byte 1000: K32 high byte 1001: K32 low byte 1010: Roffset high byte 1011: Roffset low byte 1100: Goffset high byte 1101: Goffset low byte 1110: Boffset high byte 1111: Boffset low byte	
Cb_Cr_Clamp	3	R/W	0	Cb Cr Clamp 0: Bypass 1: Cb-(512<<2), Cr-(512<<2)	
Y_Clamp	2	R/W	0	Y Clamp 0: Bypass 1: Y-(64<<2)	
dummy2	1:0	R/W	0	Reserved	

Register:: YUV_RGB_COEF_DATA					0xc1
Name	Bits	Read/Write	Reset State	Comments	Config
COEF	7:0	W	-	COEF_DATA[7:0]	

Address 0xC2~0xC6 are reserved

Vivid color-DCC (Page 7)

Register:: DCC_CTRL_0					0xc7
Name	Bits	R/W	Default	Comments	Config
DCC_EN	7	R/W	0	DCC_ENABLE 0: Disable 1: Enable	

Y_FORMULA	6	R/W	0	Y_FORMULA 0: $Y = (2R+5G+B)/8$ 1: $Y = (5R+8G+3B)/16$	
SC_EN	5	R/W	0	SOFT_CLAMP 0: Disable 1: Enable	
DCC_MODE	4	R/W	0	DCC_MODE 0: Auto Mode 1: Manual Mode	
SCG_EN	3	R/W	0	SCENE_CHANGE 0: Disable Scene-Change Function 1: Enable Scene-Change Function in Auto Mode	
BWL_EXP	2	R/W	0	BWL_EXP 0: Disable Black/White Level Expansion 1: Enable Black/White Level Expansion in Auto Mode	
PAGE_SEL	1:0	R/W	0	DCC_PAGE_SEL 00: Page 0 (for Histogram / Ymin-max / Soft-Clamping / Scene-Change) 01: Page 1 (for Y-Curve / WBL Expansion) 10: Page 2 (for Calculation Parameter) 11: Page 3 (for Testing and Debug)	

Register:: DCC_CTRL_1				0xc8	
Name	Bits	R/W	Default	Comments	Config
GAIN_EN	7	R/W	0	DCC gain control enable 0: Disable 1: Enable Note: DCC gain control enable must delay MOV_AVG_LEN frame after DCC enable.	
DCC_FLAG	6	R	0	1: time to write highlight window position & normalized factor, write to clear	
SAT_COMP_EN	5	R/W	0	Saturation Compensation Enable 0: Disable 1: Enable	
BLD_MODE	4	R/W	0	Blending Factor Control Mode 0: old mode 1: new mode (diff. regions have diff. blending factor)	
Reserved	3:0	--	0x00	Reserved to 0	

Register:: DCC Address Port				0xc9	
Name	Bits	R/W	Default	Comments	Config
DCC_ADDR	7:0	R/W	0x00	DCC address	

Register:: DCC Data Port				0xca	
Name	Bits	R/W	Default	Comments	Config
DCC_DATA	7:0	R/W	0x00	DCC data	

Register:: NOR_FACTOR_H (page0)				(ACCESS[C9,CA]) 0x00	
---------------------------------	--	--	--	----------------------	--

Name	Bits	R/W	Default	Comments	Config
Reserved	7:6	--	--	Reserved	
NOR_FAC_H	5:0	R/W	0x00	Bit[21:16] of Normalized Factor; NF=(255/N)*(2^22)	

Register:: NOR_FACTOR_M (page0) (ACCESS[C9,CA]) 0x01					
Name	Bits	R/W	Default	Comments	Config
NOR_FAC_M	7:0	R/W	0x00	Bit[15:8] of Normalized Factor; NF=(255/N)*(2^22)	

Register:: NOR_FACTOR_L (page0) (ACCESS[C9,CA]) 0x02					
Name	Bits	R/W	Default	Comments	Config
NOR_FAC_L	7:0	R/W	0x00	Bit[7:0] of Normalized Factor; NF=(255/N)*(2^22)	

Register:: BBE_CTRL (page0) (ACCESS[C9,CA]) 0x03					
Name	Bits	R/W	Default	Comments	Config
BBE_EN	7	R/W	0	BBE_ENA 0: Disable Black-Background Exception 1: Enable Black-Background Exception	
Reserved	6:4	--	--	Reserved	
BBE_THD	3:0	R/W	0x4	BBE_THD 8-bit RGB Threshold for Black-Background Exception	

Register:: NFLT_CTRL (page0) (ACCESS[C9,CA]) 0x04					
Name	Bits	R/W	Default	Comments	Config
HNFLT_EN	7	R/W	0	HNFLT_ENA 0: Disable Histogram Noise Filter 1: Enable Histogram Noise Filter	
HNFLT_THD	6:4	R/W	0	HNFLT_THD Threshold for Histogram Noise Filter	
YNFLT_EN	3	R/W	0	YNFLT_ENA 0: Disable Ymax / Ymin Noise Filter 1: Enable Ymax / Ymin Noise Filter	
YNFLT_THD	2:0	R/W	0	YNFLT_THD Threshold for Ymax/Ymin Noise Filter (= 4*YNFLT_THD)	

Register:: HIST_CTRL (page0) (ACCESS[C9,CA]) 0x05					
Name	Bits	R/W	Default	Comments	Config
RH0_LIMITER	7	R/W	0	RH0_LIMITER 0: Disable RH0 Limiter 1: Enable RH0 Limiter	

RH1_LIMITER	6	R/W	0	RH1_LIMITER 0: Disable RH1 Limiter 1: Enable RH1 Limiter	
REAL_MA_LEN	5:3	R	--	Real MOV_AVG_LEN may be different with MOV_AVG_LEN, if SCG enable	
MOV_AVG_LEN	2:0	R/W	0	MOV_AVG_LEN 000: Histogram Moving Average Length = 1 001: Histogram Moving Average Length = 2 010: Histogram Moving Average Length = 4 011: Histogram Moving Average Length = 8 100: Histogram Moving Average Length = 16 101~111: reserved	

Register:: SOFT_CLAMP (page0) (ACCESS[C9,CA]) 0x06					
Name	Bits	R/W	Default	Comments	Config
SOFT_CLAMP	7:0	R/W	0xB0	Slope of Soft-Clamping (= SOFT_CLAMP / 256)	

Register:: Y_MAX_LB (page0) (ACCESS[C9,CA]) 0x07					
Name	Bits	R/W	Default	Comments	Config
Y_MAX_LB	7:0	R/W	0xFF	Lower Bound of Y_MAX (= 4*Y_MAX_LB)	

Register:: Y_MIN_HB (page0) (ACCESS[C9,CA]) 0x08					
Name	Bits	R/W	Default	Comments	Config
Y_MIN_HB	7:0	R/W	0x00	Higher Bound of Y_MIN (= 4*Y_MIN_HB)	

Register:: SCG_PERIOD (page0) (ACCESS[C9,CA]) 0x09					
Name	Bits	R/W	Default	Comments	Config
SCG_MODE	7	R/W	0	Scene-Change Control Mode 0: old mode (2553V) 1: new mode (2622)	
Reserved	6:5	--	--	Reserved	
SCG_PERIOD	4:0	R/W	0x10	Scene-Change Mode Period = 1~32. Note: SCG_PERIOD >= MOV_AVG_LEN, CRED-05[2:0](page0)	

Register:: SCG_LB (page0) (ACCESS[C9,CA]) 0x0A					
Name	Bits	R/W	Default	Comments	Config
SCG_LB	7:0	R/W	0x00	SCG_DIFF Lower Bound for Exiting Scene-Change Mode	

Register:: SCG_HB (page0) (ACCESS[C9,CA]) 0x0B					
Name	Bits	R/W	Default	Comments	Config

SCG_HB	7:0	R/W	0xFF	SCG_DIFF Higher Bound for Exiting Scene-Change Mode	
--------	-----	-----	------	---	--

Register:: POPUP_CTRL (page0) (ACCESS[C9,CA]) 0x0C					
Name	Bits	R/W	Default	Comments	Config
Reserved	7:1	--	--	Reserved	
POPUP_BIT	0	R	--	Reg[0D]~Reg[16] are updated every frame. Once POPUP_BIT is read, the value of Reg[0D] ~ Reg[16] will not be updated until Reg[16] is read.	

Register:: SCG_DIFF (page0) (ACCESS[C9,CA]) 0x0D					
Name	Bits	R/W	Default	Comments	Config
SCG_DIFF	7:0	R	--	= (Histogram Difference between Current Frame and Average) / 8	

Register:: Y_MAX_VAL (page0) (ACCESS[C9,CA]) 0x0E					
Name	Bits	R/W	Default	Comments	Config
Y_MAX_VAL	7:0	R	--	= Max { Y_MAX_LB, (Y Maximum in Current Frame / 4) }	

Register:: Y_MIN_VAL (page0) (ACCESS[C9,CA]) 0x0F					
Name	Bits	R/W	Default	Comments	Config
Y_MIN_VAL	7:0	R	--	= Min { Y_MIN_HB, (Y Minimum in Current Frame / 4) }	

Register:: S0_VALUE (page0) (ACCESS[C9,CA]) 0x10					
Name	Bits	R/W	Default	Comments	Config
S0_VALUE	7:0	R	--	Normalized Histogram S0 Value	

Register:: S1_VALUE (page0) (ACCESS[C9,CA]) 0x11					
Name	Bits	R/W	Default	Comments	Config
S1_VALUE	7:0	R	--	Normalized Histogram S1 Value	

Register:: S2_VALUE (page0) (ACCESS[C9,CA]) 0x12					
Name	Bits	R/W	Default	Comments	Config
S2_VALUE	7:0	R	--	Normalized Histogram S2 Value	

Register:: S3_VALUE (page0) (ACCESS[C9,CA]) 0x13					
Name	Bits	R/W	Default	Comments	Config

S3_VALUE	7:0	R	--	Normalized Histogram S3 Value	
----------	-----	---	----	-------------------------------	--

Register:: S4_VALUE (page0)		(ACCESS[C9,CA]) 0x14			
------------------------------------	--	-----------------------------	--	--	--

Name	Bits	R/W	Default	Comments	Config
S4_VALUE	7:0	R	--	Normalized Histogram S4 Value	

Register:: S5_VALUE (page0)		(ACCESS[C9,CA]) 0x15			
------------------------------------	--	-----------------------------	--	--	--

Name	Bits	R/W	Default	Comments	Config
S5_VALUE	7:0	R	--	Normalized Histogram S5 Value	

Register:: S6_VALUE (page0)		(ACCESS[C9,CA]) 0x16			
------------------------------------	--	-----------------------------	--	--	--

Name	Bits	R/W	Default	Comments	Config
S6_VALUE	7:0	R	--	Normalized Histogram S6 Value	

Register:: DEF_CRV[01] (page1)		(ACCESS[C9,CA]) 0x00			
---------------------------------------	--	-----------------------------	--	--	--

Name	Bits	R/W	Default	Comments	Config
DEF_CRV01	7:0	R/W	0x10	Pre-Defined Y-Curve; Keep DEF_CRV[N] ≥ DEF_CRV[N-1]	

Register:: DEF_CRV[02] (page1)		(ACCESS[C9,CA]) 0x01			
---------------------------------------	--	-----------------------------	--	--	--

Name	Bits	R/W	Default	Comments	Config
DEF_CRV02	7:0	R/W	0x20	Pre-Defined Y-Curve; Keep DEF_CRV[N] ≥ DEF_CRV[N-1]	

Register:: DEF_CRV[03] (page1)		(ACCESS[C9,CA]) 0x02			
---------------------------------------	--	-----------------------------	--	--	--

Name	Bits	R/W	Default	Comments	Config
DEF_CRV03	7:0	R/W	0x30	Pre-Defined Y-Curve; Keep DEF_CRV[N] ≥ DEF_CRV[N-1]	

Register:: DEF_CRV[04] (page1)		(ACCESS[C9,CA]) 0x03			
---------------------------------------	--	-----------------------------	--	--	--

Name	Bits	R/W	Default	Comments	Config
DEF_CRV04	7:0	R/W	0x40	Pre-Defined Y-Curve; Keep DEF_CRV[N] ≥ DEF_CRV[N-1]	

Register:: DEF_CRV[05] (page1)		(ACCESS[C9,CA]) 0x04			
---------------------------------------	--	-----------------------------	--	--	--

Name	Bits	R/W	Default	Comments	Config
DEF_CRV05	7:0	R/W	0x50	Pre-Defined Y-Curve; Keep DEF_CRV[N] ≥ DEF_CRV[N-1]	

Register:: DEF_CRV[06] (page1) (ACCESS[C9,CA]) 0x05					
Name	Bits	R/W	Default	Comments	Config
DEF_CRV06	7:0	R/W	0x60	Pre-Defined Y-Curve; Keep DEF_CRV[N] ≥ DEF_CRV[N-1]	

Register:: DEF_CRV[07] (page1) (ACCESS[C9,CA]) 0x06					
Name	Bits	R/W	Default	Comments	Config
DEF_CRV07	7:0	R/W	0x70	Pre-Defined Y-Curve; Keep DEF_CRV[N] ≥ DEF_CRV[N-1]	

Register:: DEF_CRV[08] (page1) (ACCESS[C9,CA]) 0x07					
Name	Bits	R/W	Default	Comments	Config
DEF_CRV08	7:0	R/W	0x80	Pre-Defined Y-Curve; Keep DEF_CRV[N] ≥ DEF_CRV[N-1]	

Register:: DEF_CRV[09] (page1) (ACCESS[C9,CA]) 0x08					
Name	Bits	R/W	Default	Comments	Config
DEF_CRV09	7:0	R/W	0x90	Pre-Defined Y-Curve; Keep DEF_CRV[N] ≥ DEF_CRV[N-1]	

Register:: DEF_CRV[10] (page1) (ACCESS[C9,CA]) 0x09					
Name	Bits	R/W	Default	Comments	Config
DEF_CRV10	7:0	R/W	0xA0	Pre-Defined Y-Curve; Keep DEF_CRV[N] ≥ DEF_CRV[N-1]	

Register:: DEF_CRV[11] (page1) (ACCESS[C9,CA]) 0x0A					
Name	Bits	R/W	Default	Comments	Config
DEF_CRV11	7:0	R/W	0xB0	Pre-Defined Y-Curve; Keep DEF_CRV[N] ≥ DEF_CRV[N-1]	

Register:: DEF_CRV[12] (page1) (ACCESS[C9,CA]) 0x0B					
Name	Bits	R/W	Default	Comments	Config
DEF_CRV12	7:0	R/W	0xC0	Pre-Defined Y-Curve; Keep DEF_CRV[N] ≥ DEF_CRV[N-1]	

Register:: DEF_CRV[13] (page1) (ACCESS[C9,CA]) 0x0C					
Name	Bits	R/W	Default	Comments	Config
DEF_CRV13	7:0	R/W	0xD0	Pre-Defined Y-Curve; Keep DEF_CRV[N] ≥ DEF_CRV[N-1]	

Register:: DEF_CRV[14] (page1) (ACCESS[C9,CA]) 0x0D					
Name	Bits	R/W	Default	Comments	Config
DEF_CRV14	7:0	R/W	0xE0	Pre-Defined Y-Curve; Keep DEF_CRV[N] ≥ DEF_CRV[N-1]	

Register:: DEF_CRV[15] (page1) (ACCESS[C9,CA]) 0x0E					
Name	Bits	R/W	Default	Comments	Config
DEF_CRV15	7:0	R/W	0xF0	Pre-Defined Y-Curve; Keep DEF_CRV[N] ≥ DEF_CRV[N-1]	

Register:: DEF_CRV[16] (page1) (ACCESS[C9,CA]) 0x0F					
Name	Bits	R/W	Default	Comments	Config
DEF_CRV16	7:0	R/W	0x00	Pre-Defined Y-Curve; Keep DEF_CRV[N] ≥ DEF_CRV[N-1] Note : default = 0x00 means 0x100 (256)	

Register:: Y_BL_BIAS (page1) (ACCESS[C9,CA]) 0x10					
Name	Bits	R/W	Default	Comments	Config
Y_BL_BIAS	7:0	R/W	0x00	Y Offset for Black-Level Expansion (Y_L' = 4*Y_BL_BIAS)	

Register:: Y_WL_BIAS (page1) (ACCESS[C9,CA]) 0x11					
Name	Bits	R/W	Default	Comments	Config
Y_WL_BIAS	7:0	R/W	0x00	Y Offset for White-Level Expansion (1023-Y_H' = 4*Y_WL_BIAS)	

Load double buffer CRED-00 ~ CRED-11 (page1) after write CRED-11 when DCC enable

Register:: SAT_FACTOR (page1) (ACCESS[C9,CA]) 0x12					
Name	Bits	R/W	Default	Comments	Config
Reserved	7:6	--	--	Reserved	
SAT_FACTOR	5:0	R/W	0x00	Saturation Compensation Factor = 0 ~ 32.	

Register:: BLD_UB (page1) (ACCESS[C9,CA]) 0x13					
Name	Bits	R/W	Default	Comments	Config
BLD_UB	7:0	R/W	0x00	Upper Bound of Blending Factor	

Register:: BLD_LB (page1) (ACCESS[C9,CA]) 0x14					
Name	Bits	R/W	Default	Comments	Config
BLD_LB	7:0	R/W	0x00	Lower Bound of Blending Factor	

Register:: DEV_FACTOR (page1) (ACCESS[C9,CA]) 0x15					
Name	Bits	R/W	Default	Comments	Config
DEV_FACTOR	7:0	R/W	0x00	Deviation Weighting Factor	

Register:: BLD_VAL_SEL (page1) (ACCESS[C9,CA]) 0x16					
Name	Bits	R/W	Default	Comments	Config
WL_RANGE	7:6	R/W	0x00	White-Level Range 00: Yi = 512 (Z8) 01: Yi = 576 (Z9) 10: Yi = 640 (Z10) 11: Yi = 704 (Z11)	
WL_BLD_VAL	5:4	R/W	0x00	White-Level Blending Factor 00: 0 (user-defined curve) 01: R/2 10: R 11: 2R	
BL_RANGE	3:2	R/W	0x00	Black-Level Range 00: Yi = 448 (Z7) 01: Yi = 384 (Z6) 10: Yi = 320 (Z5) 11: Yi = 256 (Z4)	
BL_BLD_VAL	1:0	R/W	0x00	Black-Level Blending Factor 00: 0 (user-defined curve) 01: R/2 10: R 11: 2R	

Register:: BLD_VAL (page1) (ACCESS[C9,CA]) 0x17					
Name	Bits	R/W	Default	Comments	Config
BLD_VAL	7:0	R	--	= Max{ BLD_UB - [(DEV_VAL*DEV_FACTOR)/256], BLD_LB}	

Register:: DEV_VAL_HI (page1) (ACCESS[C9,CA]) 0x18					
Name	Bits	R/W	Default	Comments	Config
DEV_VAL_HI	7:0	R	--	Bit[8:1] of Deviation Value	

Register:: DEV_VAL_LO (page1) (ACCESS[C9,CA]) 0x19					
Name	Bits	R/W	Default	Comments	Config
DEV_VAL_LO	7	R	--	Bit[0] of Deviation Value	
Reserved	6:0	--	--	Reserved	

Register:: SRAM initial value (page2) (ACCESS[C9,CA]) 0x00-0x8F					
Name	Bits	R/W	Default	Comments	Config

SRAM_XX	7:0	W	--	Addr 00: SRAM_00 Addr 01: SRAM_01 Addr 8F : SRAM_8F	
---------	-----	---	----	---	--

Register:: SRAM_BIST (page3)				(ACCESS[C9,CA]) 0x00	
Name	Bits	R/W	Default	Comments	Config
BIST_EN	7	R/W	0	BIST_EN 0: disable 1: enable	
RAM_Mode	6	R/W	0	RAM_Mode 0: dclk domain mode (normal mode, BIST) 1: MCU domain mode (SCG test)	
Reserved	5:2	--	--	Reserved	
BIST_PERIOD	1	R	--	BIST_Period 0: BIST is done 1: BIST is running	
BIST_OK	0	R	--	BIST_OK 0: SRAM fail 1: SRAM ok	

Address 0xCB~0xCF are reserved

ICM (Page 7)

Address: D0 ICM Control

Default: 00h

Bit	Mode	Function
7	R/W	ICM Enable 0: Disable 1: Enable
6	R/W	Y Correction Mode 0: $dY = (8dU+dV)/8$ 1: $dY = (6dU+dV)/8$
5	R/W	ICM U/V Delta Range: 0: Original -128~+127 1: Double -256~254
4	R/W	CM0 Enable 0: Disable 1: Enable
3	R/W	CM1 Enable 0: Disable 1: Enable
	R/W	CM2 Enable 0: Disable 1: Enable
1	R/W	CM3 Enable 0: Disable 1: Enable
0	R/W	CM4 Enable 0: Disable 1: Enable

Address: D1

ICM_SEL

Default: 00h

Bit	Mode	Function
-----	------	----------

7:5	R/W	ICM Test Mode 000: disable 001: bypass U, V result 010: bypass hue/saturation result 011: bypass dU, dV value 1xx: R,B as LUT input, and bypass LUT output to R/G/B output
4	--	reserved
3	R/W	CM5 Enable 0: Disable 1: Enable
2:0	R/W	CM Select 000: Select Chroma Modifier 0 for Accessing Through Data Port 001: Select Chroma Modifier 1 for Accessing Through Data Port 010: Select Chroma Modifier 2 for Accessing Through Data Port 011: Select Chroma Modifier 3 for Accessing Through Data Port 100: Select Chroma Modifier 4 for Accessing Through Data Port 101: Select Chroma Modifier 5 for Accessing Through Data Port 110~111: reserved

Address: D2 ICM_ADDR **Default: 00h**

Bit	Mode	Function
7:0	R/W	ICM port address

Address: D3 ICM_Data

Bit	Mode	Function
7:0	R/W	ICM port data

ICM_ADDR will be increased automatically after each byte of ICM_DATA has been accessed.

Address: D3-00 MST_HUE_HB **Default: x0h**

Bit	Mode	Function
7:4	--	Reserved
3:0	W	High Byte[11:8] of Master Hue for Chroma Modifier N.

Address: D3-01 MST_HUE_LB **Default: 00h**

Bit	Mode	Function
7:0	W	Low Byte[7:0] of Master Hue for Chroma Modifier N.

Address: D3-02 HUE_SET **Default: 00h**

Bit	Mode	Function
7:6	W	CM[N]_LWID 00: CM[N] left width = 64 01: CM[N] left width = 128 10: CM[N] left width = 256 11: CM[N] left width = 512
5:4	W	CM[N]_LBUF 00: CM[N] left Buffer = 0 01: CM[N] left Buffer = 64 10: CM[N] left Buffer = 128 11: CM[N] left Buffer = 256
3:2	W	CM[N]_RWID 00: CM[N] right width = 64 01: CM[N] right width = 128 10: CM[N] right width = 256 11: CM[N] right width = 512
1:0	W	CM[N]_RBUF 00: CM[N] right Buffer = 0 01: CM[N] right Buffer = 64 10: CM[N] right Buffer = 128 11: CM[N] right Buffer = 256

Address: D3-03~32		U/V Offset	Default: 00h
Bit	Mode	Function	
7:0	W	Addr 03: U Offset 00, -128~127 Addr 04: V Offset 00, -128~127 Addr 05: U Offset 01, -128~127 Addr 06: V Offset 01, -128~127 Addr 07: U Offset 02, -128~127 Addr 08: V Offset 02, -128~127 Addr 09: U Offset 03, -128~127 Addr 0A: V Offset 03, -128~127 Addr 0B: U Offset 04, -128~127 Addr 0C: V Offset 04, -128~127 Addr 0D: U Offset 05, -128~127 Addr 0E: V Offset 05, -128~127 Addr 0F: U Offset 06, -128~127 Addr 10: V Offset 06, -128~127 Addr 11: U Offset 07, -128~127 Addr 12: V Offset 07, -128~127 Addr 13: U Offset 10, -128~127 Addr 14: V Offset 10, -128~127 Addr 15: U Offset 11, -128~127 Addr 16: V Offset 11, -128~127 Addr 17: U Offset 12, -128~127 Addr 18: V Offset 12, -128~127 Addr 19: U Offset 13, -128~127 Addr 1A: V Offset 13, -128~127 Addr 1B: U Offset 14, -128~127 Addr 1C: V Offset 14, -128~127 Addr 1D: U Offset 15, -128~127 Addr 1E: V Offset 15, -128~127 Addr 1F: U Offset 16, -128~127 Addr 20: V Offset 16, -128~127 Addr 21: U Offset 17, -128~127 Addr 22: V Offset 17, -128~127 Addr 23: U Offset 20, -128~127 Addr 24: V Offset 20, -128~127 Addr 25: U Offset 21, -128~127 Addr 26: V Offset 21, -128~127 Addr 27: U Offset 22, -128~127 Addr 28: V Offset 22, -128~127 Addr 29: U Offset 23, -128~127 Addr 2A: V Offset 23, -128~127 Addr 2B: U Offset 24, -128~127 Addr 2C: V Offset 24, -128~127 Addr 2D: U Offset 25, -128~127 Addr 2E: V Offset 25, -128~127 Addr 2F: U Offset 26, -128~127 Addr 30: V Offset 26, -128~127 Addr 31: U Offset 27, -128~127 Addr 32: V Offset 27, -128~127	

Y-Peaking filter and coring control (For Display Domain)

Address: D6 peaking/coring access port control Default: 00h

Bit	Mode	Function
7	R/W	Enable peaking / coring access port
6	R/W	Peaking/coring Enable 0: Disable 1: Enable
5	R/W	Y peaking Coefficient Resolution 0: n/32 1: n/64
4:3	--	Reserved
2:0	R/W	Peaking/coring port address

Address: D7-00 Peaking_Coef0

Bit	Mode	Function
7:0	R/W	Coefficient C0 of Peaking filter: Valid Range: -128/32(-128) ~ 127/32 (127) (2's complement)

Address: D7-01 Peaking_Coef1

Bit	Mode	Function
7:0	R/W	Coefficient C1 of Peaking filter: Valid Range: -128/32(-128) ~ 127/32 (127) (2's complement)

Address: D7-02 Peaking_Coef2

Bit	Mode	Function
7:0	R/W	Coefficient C2 of Peaking filter: Valid Range: -128/32(-128) ~ 127/32 (127) (2's complement)

Address: D7-03 Coring_Min

Bit	Mode	Function
7:5	R/W	Reserved
4:0	R/W	Coring Minimum value

Address: D7-04 Coring_Max_Pos

Bit	Mode	Function
7:0	R/W	Coring Maximum Positive value

Address: D7-05 Coring_Max_Neg

Bit	Mode	Function
7:0	R/W	Coring Maximum Negative value (2's complement)

Hue/Saturation Control (Page 7)

Register:: HUE_SAT_GC_H					0xD8
Name	Bits	Read/Write	Reset State	Comments	Config
Reserved	7			Reserved	
HUE_EN	6	R/W		Enable Hue/Sat	
CON_EN	5	R/w		Enable Contrast	
BRI_EN	4	R/W		Enable Brightness	
GC_H	3:0	R/W		GC [11:8]	

Register:: HUE_SAT_GC_L					0xD9
Name	Bits	Read/Write	Reset State	Comments	Config
GC_L	7:0	R/W		GC [7:0]	

Register:: HUE_SAT_GS_H					
Name	Bits	Read/Write	Reset State	Comments	Config
Reserved	7:4			Reserved	
GS_H	3:0	R/W		GS [11:8]	

Register:: HUE_SAT_GS_L					0xDB
Name	Bits	Read/Write	Reset State	Comments	Config
GS_L	7:0	R/W		GS [7:0]	

Contrast/Brightness Control (Page 7)

Register:: CON_COEF0xDC					
Name	Bits	Read/Write	Reset State	Comments	Config
CON_COEF	7:0	R/W		Contrast Y coefficient Valid range: 0 ~ 2	

Register:: BRI_COEF0xDD					
Name	Bits	Read/Write	Reset State	Comments	Config
BRI_COEF	7:0	R/W		Brightness Y coefficient Valid range: -128 ~ 127	

Page 8 Video decoder

Video Control Register

Register::VIDEO_CONTROL0				0xA0	
Name	Bits	Read/Write	Reset State	Comments	Config
hv_delay	7	R/W	0	Emulates the HV-delay mode found on Sony studio monitors. 0: disable 1: enable	
hpixel	6:5	R/W	0	Select the output display format. 00: 858pixels/line @ NTSC, PAL (M) 01: 864pixels/line @ PAL (B, D, G, H, I, N, CN), SECAM 10: 780pixels/line @ NTSC Square Pixel, PAL (M) Square Pixel 11: 944pixels/line @ PAL (B, D, G, H, I, N) Square Pixel	
Vline_625	4	R/W	0	Select the numbers of scan lines per frame. 0: 525 1: 625	
Colour_mode	3:1	R/W	0	Select video color standard. 000: NTSC 001: PAL (I, B, G, H, D, N) 010: PAL (M) 011: PAL (CN) 100: SECAM 101: NTSC443(1127 & 135mode) 110: NTSC443(1126 & 234mode) 111: PAL60 mode	
reserved	0	--	--	reserved	

Register::VIDEO_CONTROL1				0xA1	
Name	Bits	Read/Write	Reset State	Comments	Config
cv_inv	7	R/W	0	inverts the select signal for the analog input multiplexer during component video mode. 0: not inverted 1: inverted	
cv_src	6	R/W	0	enables the component video input format. 0: disable the component video input 1: component-video (Y, Pb, Pr)	
yc_src	5	R/W	0	selects input video format. 0: composite 1: S-Video (separated Y/C)	
reserved	4:1	--	--	reserved	
ped	0	R/W	1	enables black level correction for 7.5 blank-to-black setup (pedestal) 0: no pedestal subtraction 1: pedestal subtraction	

Switch Control Registers

Register::AD_SW_CTRL		0xA2			
Name	Bits	Read/Write	Reset State	Comments	Config
clamp_A_up_en	7	R/W	0	clamping up enable for ADC1.	
clamp_A_dn_en	6	R/W	0	clamping down enable for ADC1.	
clamp_B_up_en	5	R/W	0	clamping up enable for ADC2.	
clamp_B_dn_en	4	R/W	0	clamping down enable for ADC2.	
reserved	3:2	--	--	reserved	
Sw_Y	1	R/W	0	switch for CVBS/Y part. Also select Yup/dn clamp signal output to ADCx. 0: from AD1 1: from AD2	
Sw_C	0	R/W	1	switch of C/Pb/Pr part. Also select Cup/dn clamp signal output to ADCx. 0: from AD1 1: from AD2	

Register::AGC_GATE_TH_SWAP		0xA3			
Name	Bits	Read/Write	Reset State	Comments	Config
adc_updn_swap	7	R/W	1	swaps the DC clamp up/down controls to the analog front-end. 0: disabled 1: enabled	
adc_input_swap	6	R/W	0	swaps the MSBs and LSBs from the analog front-end's ADC. 0: disabled 1: enabled	
adc_cbr_pump_swap	5	R/W	0	swaps the Pb/Pr charge pump pairs to analog front-end. 0: disabled 1: enabled	
agc_gate_thresh	4:0	R/W	0x0a	threshold at which the rough gate generator creates a sync gate.	

Register::INOUT_CTRL		0xA4			
Name	Bits	Read/Write	Reset State	Comments	Config
fe_fil_sel	7:6	R/W	0	Front-end ADC digital filter select 00 : Bypass 01 : 5.5MHz 10 : 6.5MHz 11 : 7.5MHz	
be_fil_sel	5:4	R/W	0	Back-end digital filter (after FIFO) select 00 : Bypass 01 : 4.8MHz 10 : 5.3MHz 11 : 5.8MHz	
Bypass_sel	3	R/W	0	Back-end digital filter bypass delay select 1: bypass with delay. 0: bypass without delay.	
cout_limit	2	R/W	0	Limit the cb/cr output range. 0: limit to 64~960.(10bit output) 1: limit to 1~1023. (10bit output)	
444out_sel	1	R/W	0	4:4:4 output select 1: 4:4:4 output 0: 4:2:2 output	
Aa422_en	0	R/W	0	Enable the 1-2-1 AA filter when output 4:2:2 format.	

Address: 0xA5 ~ 0xA6

Reserved

Register::OUTPUT_CONTROL					0xA7	
Name	Bits	Read/Write	Reset State	Comments	Config	
snow_freerun_en	7	R/W	1	Enable the freerun timing of the TV snow noise		
cbcr_swap	6	R/W	0	swaps Cb/Cr outputs. 0: don't swap Cb/Cr 1: swap Cb/Cr		
blue_mode	5:4	R/W	0x02	controls the blue screen mode. 00: disable 01: enabled 10: auto 11: reserved		
yc_delay	3:0	R/W	0	2's complement number controls the output delay between luma and chroma. Negative values shift luma outputs to the left while positive values shift luma values to the right. The range is [-5,7].		

Luma Adjustment Registers

Register::LUMA_CONTRAST_ADJ					0xA8	
Name	Bits	Read/Write	Reset State	Comments	Config	
contrast	7:0	R/W	0x80	These bits control the adjustable gain to the luma output path.		

Register::LUMA_BRIGHTNESS_ADJ					0xA9	
Name	Bits	Read/Write	Reset State	Comments	Config	
brightness	7:0	R/W	0x80	These bits controls the adjustable brightness level to the luma output path. This value is offset by -128, i.e., a value of 128 implies a brightness of level 0, and a value of 0 implies a brightness level of -128.		

Chroma Adjustment Registers

Register::CHROMA SATURATION_ADJ					0xAA	
Name	Bits	Read/Write	Reset State	Comments	Config	
saturation	7:0	R/W	0x80	adjust the color saturation.		

Register::CHROMA_HUE_PHASE_ADJ					0xAB	
Name	Bits	Read/Write	Reset State	Comments	Config	
hue	7:0	R/W	0x00	this 2's complement number adjusts the hue phase offset.		

DC Balance Control

Register::DC_HACTIVE_START 0xAC					
Name	Bits	Read/Write	Reset State	Comments	Config
dc_h_start	7:0	R/W	0x00	Set the window for dc measure, start position per line. The realistic value is extend the value 2 bit For example : dc_h_start=5 , h_start at 20th pixel	

Register::DC_VACTIVE_START 0xAD					
Name	Bits	Read/Write	Reset State	Comments	Config
dc_v_start	7:0	R/W	0x00	Set the window for dc measure, start line count per frame. The realistic value is extend the value 1 bit For example : dc_v_start=5 , v_start at 10th line	

Register::DC_THRESHOLD 0xAE					
Name	Bits	Read/Write	Reset State	Comments	Config
dc_thr	7:0	R/W	0x75	Set the threshold for auto level control. The realistic value is extend the value 2 bit. For example, dc_thr = 5, threshold = 20	

Register::DC_POSITIVE_GAIN 0xAF					
Name	Bits	Read/Write	Reset State	Comments	Config
Dc_gain_p	7:0	R/W	0xC0	Set the gain value when the sign of ydc- dc_thr*4 is positive	

Register::DC_NEGATIVE_GAIN 0xB0					
Name	Bits	Read/Write	Reset State	Comments	Config
Dc_gain_n	7:0	R/W	0x50	Set the gain value when the sign of ydc- dc_thr*4 is negative	

Register::YDC_STATUS 0xB1					
Name	Bits	Read/Write	Reset State	Comments	Config
Status_ydc	7:0	R	0	Status of luma dc value /4 per frame.	

Register::YDC_AVERAGE_STATUS 0xB2					
Name	Bits	Read/Write	Reset State	Comments	Config
Status_ydc_avg	7:0	R	0	Status of luma dc value /4 over 16 frame.	

Register::DC_BALANCE_CTRL0 0xB3					
Name	Bits	Read/Write	Reset State	Comments	Config
DC_h_width	7:5	R/W	0x00	H window width . 0: 720 pixels 1: 512 pixels 2: 256 pixels 3: 128 pixels 4: 64 pixels	
DC_v_height	4:3	R/W	0x00	V window height .	

				0: 480 lines 1: 256 lines 2: 128 lines 3: 64 lines	
Dc_comp_sel	2	R/W	0x01	The selection of dc 0: with ydc 1: with ydc_avg	
dcgain_en	1	R/W	0x00	Enable the dc gain control machine. 0:disable 1:enable	
Dc_comp_ctrl	0	R/W	0x00	The selection of dc comparison 0: with register dc_thr 1: with ydc_avg	

Register::DC_BALANCE_CTRL1 0xB4					
Name	Bits	Read/Write	Reset State	Comments	Config
reserved	7:5	--	--	Reserved	
DC_offset_sel	4	R/W	0x00	0: dc level is decreased 1: dc level is increased	
DC_offset_gain	3:0	R/W	0x00	DC offset gain. Value of 0 means no DC offset.	

IRQ Registers

Register::IRQ_MASK1 0xB5					
Name	Bits	Read/Write	Reset State	Comments	Config
vcr_irq_en	7	R/W	0	VCR interrupt enable.	
Nosig_irq_en	6	R/W	0	No_signal interrupt enable.	
Mode_irq_en	5	R/W	0	Mode change interrupt enable.	
Proscan_irq_en	4	R/W	0	Interlaced/non-interlaced interrupt enable.	
Noisy_irq_en	3	R/W	0	Noisy interrupt enable.	
chromalock_irq_en	2	R/W	0	chromalock interrupt enable.	
vlock_irq_en	1	R/W	0	vlock interrupt enable.	
hlock_irq_en	0	R/W	0	hlock interrupt enable.	

Register::IRQ_MASK2 0xB6					
Name	Bits	Read/Write	Reset State	Comments	Config
ad1_over_irq_en	7	R/W	0	adc1_overflow interrupt enable	
ad1_under_irq_en	6	R/W	0	adc1_underflow interrupt enable	
ad2_over_irq_en	5	R/W	0	adc2_overflow interrupt enable	
ad2_under_irq_en	4	R/W	0	adc2_underflow interrupt enable	
reserved	3:2	--	--	reserved	
Mv_irq_en	1	R/W	0	Macrovision VBI pseudo-sync pulses interrupt enable.	
Field_irq_en	0	R/W	0	Field interrupt enable.	

Register::IRQ_STATUS1 0xB7					
Name	Bits	Read/Write	Reset State	Comments	Config

vcr_irq	7	R	0	vcr or vcr_trick flag status change, the IRQ will be triggered. Once IRQ triggered, it must write 1 to clear. Only active when vcr_irq_en = 1.	
Nosig_irq	6	R	0	No_signal flag status change, the IRQ will be triggered. Once IRQ triggered, it must write 1 to clear. Only active when nosig_irq_en = 1.	
Mode_irq	5	R	0	Reg_decision_mode_status change, the IRQ will be triggered. Once IRQ triggered, it must write 1 to clear. Only active when mode_irq_en = 1.	
Proscan_irq	4	R	0	proscan flag status change, the IRQ will be triggered. Once IRQ triggered, it must write 1 to clear. Only active when proscan_irq_en = 1.	
Noisy_irq	3	R	0	noisy flag status change, the IRQ will be triggered. Once IRQ triggered, it must write 1 to clear. Only active when noisy_irq_en = 1.	
chromalock_irq	2	R	0	Chromalock flag status change, the IRQ will be triggered. Once IRQ triggered, it must write 1 to clear. Only active when lock_irq_en = 1.	
vlock_irq	1	R	0	vlock flag status change, the IRQ will be triggered. Once IRQ triggered, it must write 1 to clear. Only active when lock_irq_en = 1.	
hlock_irq	0	R	0	hlock flag status change, the IRQ will be triggered. Once IRQ triggered, it must write 1 to clear. Only active when lock_irq_en = 1.	

Register::IRQ_STATUS1_WCLR 0xB8					
Name	Bits	Read/Write	Reset State	Comments	Config
vcr_irq_wclr_out	7	R/W	0	Write 1 to clear	
Nosig_irq_wclr_out	6	R/W	0	Write 1 to clear	
Mode_irq_wclr_out	5	R/W	0	Write 1 to clear	
Proscan_irq_wclr_out	4	R/W	0	Write 1 to clear	
Noisy_irq_wclr_out	3	R/W	0	Write 1 to clear	
chromalock_irq_wclr_out	2	R/W	0	Write 1 to clear	
vlock_irq_wclr_out	1	R/W	0	Write 1 to clear	
hlock_irq_wclr_out	0	R/W	0	Write 1 to clear	

Register::IRQ_STATUS2 0xB9					
Name	Bits	Read/Write	Reset State	Comments	Config
ad1_overflow_irq	7	R	0	adc1_overflow flag status set, the IRQ will be triggered. Once IRQ triggered, it must write 1 to clear. Only active when ad1_over_irq_en = 1.	
ad1_underflow_irq	6	R	0	adc1_underflow flag status set, the IRQ will be triggered. Once IRQ triggered, it must write 1 to clear. Only active when adc1_under_irq_en = 1.	
ad2_overflow_irq	5	R	0	adc2_overflow flag status set, the IRQ will be triggered. Once IRQ triggered, it must write 1 to clear. Only active when adc2_over_irq_en = 1.	

ad2_underflow_irq	4	R	0	adc2_underflow flag status set, the IRQ will be triggered. Once IRQ triggered, it must write 1 to clear. Only active when adc2_under_irq_en = 1.	
reserved	3:2	--	--	reserved	
Mv_irq	1	R	0	Mv_detected flag status change, the IRQ will be triggered. Once IRQ triggered, it must write 1 to clear. Only active when mv_irq_en = 1.	
Field_irq	0	R	0	Field. If the IRQ is enabled, it will be triggered every field. it must write 1 to clear. Only active when field_irq_en = 1.	

Register::IRQ_STATUS2_WCLR				0xBA	
Name	Bits	Read/Write	Reset State	Comments	Config
ad1_overflow_irq_wclr_out	7	R/W	0	Wirte 1 to clear	
ad1_underflow_irq_wclr_out	6	R/W	0	Wirte 1 to clear	
ad2_overflow_irq_wclr_out	5	R/W	0	Wirte 1 to clear	
ad2_underflow_irq_wclr_out	4	R/W	0	Wirte 1 to clear	
reserved	3:2	--	--	reserved	
Mv_irq_wclr_out	1	R/W	0	Wirte 1 to clear	
Field_irq_wclr_out	0	R/W	0	Wirte 1 to clear	

Register::ADC_LIMIT_THRESHOLD				0xBB	
Name	Bits	Read/Write	Reset State	Comments	Config
adc_over_threh	7:4	R/W	0	adc data top value threshold. If the overflow irq enable, the relative adc overflow irq will be set when the data exceed 4095 – the register value.	
adc_under_threh	3:0	R/W	0	adc data bottom value threshold. If the underflow irq enable, the relative adc underflow irq will be set when the data less than the register value.	

Status Registers_1

Register::				0xBC	
Name	Bits	Read/Write	Reset State	Comments	Config
mv_colourstripes	7:5	R	0	macro-vision color stripes detected. The number indicates the number of color stripe lines in each group.	
mv_vbi_detected	4	R	0	macro-vision VBI pseudo-sync pulses detection 0: undetected 1: detected	
chomalock	3	R	0	chroma PLL locked to colour burst. 0: unlocked 1: locked	
vlock	2	R	0	vertical lock. 0: unlocked 1: locked	
hlock	1	R	0	horizontal line locked. 0: unlocked	

no_signal	0	R	0	1: locked no signal detection. 0: signal detected 1: no signal detected	
------------------	---	---	---	--	--

Register::VIDEO_STATUS_REG2 0xBD					
Name	Bits	Read/Write	Reset State	Comments	Config
reserved	7:5	--	--	Reserved.	
Detect443_flag	4	R	0	Freq 4.43MHz flag Burst frequency is near 4.43MHz or near 3.58MHz.	
Burst_detect	3	R	0	If burst magnitude is big enough. 0 : no burst detected 1 : burst detected	
PALor_flag	2	R	0	PALm flag or pal flag	
PALm_flag	1	R	0	PAL color mode detected.	
proscan_detected	0	R	0	progressive scan detected.	

Register::VIDEO_STATUS_REG3 0xBE					
Name	Bits	Read/Write	Reset State	Comments	Config
vcr_rew	7	R	0	VCR rewind detected.	
vcr_ff	6	R	0	VCR fast-forward detected.	
vcr_trick	5	R	0	VCR trick-mode detected.	
vcr	4	R	0	VCR detected.	
noisy	3	R	0	noisy signal detected. This bit is set when the detected noise value (status register 7Fh) is greater than the value programmed into the "noise_thresh" register (05h).	
Lines_625_detected	2	R	0	625 scan lines detected.	
SECAM_detected	1	R	0	SECAM color mode detected.	
PAL_detected	0	R	0	PAL color mode detected.	

Register::NOISE_THRESHOLD 0xBF					
Name	Bits	Read/Write	Reset State	Comments	Config
noise_thresh	7:0	R/W	0x32	sets the noise value at which the circuit considers a signal noisy. The detected noise value may be read back through register 7Fh ("status_noise"). If the detected noise value is greater than "noise_thresh", then register bit 3C.3h ("noisy") is set. Larger values of "status_noise" indicate noisier signals, so larger values of "noise_thresh" decreases the likelihood of "noisy" being set while smaller values of "noise_thresh" increases the likelihood of "noisy" being set.	

Status Registers_2

Register::HDTO_INC_STATUS4 0xC0					
Name	Bits	Read/Write	Reset State	Comments	Config
reserved	7:6	--	--	reserved.	
hdto_inc[29:24]	5:0	R	0	status bits 29:24 of the 30-bit-wide horizontal sync DTO	

				increment.	
--	--	--	--	------------	--

Register::HDTO_INC_STATUS3 0xC1					
Name	Bits	Read/Write	Reset State	Comments	Config
hdto_inc[23:16]	7:0	R	0	status bits 23:16 of the 30-bit-wide horizontal sync DTO increment.	

Register::HDTO_INC_STATUS2 0xC2					
Name	Bits	Read/Write	Reset State	Comments	Config
hdto_inc[15:8]	7:0	R	0	status bits 15:8 of the 30-bit-wide horizontal sync DTO increment.	

Register::HDTO_INC_STATUS1 0xC3					
Name	Bits	Read/Write	Reset State	Comments	Config
hdto_inc[7:0]	7:0	R	0	status bits 7:0 of the 30-bit-wide horizontal sync DTO increment.	

Register::CDTO_INC_STATUS4 0xC4					
Name	Bits	Read/Write	Reset State	Comments	Config
reserved	7:6	--	--	Reserved.	
cdto_inc[29:24]	5:0	R	0	status bits 29:24 of the 30-bit-wide chroma sync DTO increment.	

Register::CDTO_INC_STATUS3 0xC5					
Name	Bits	Read/Write	Reset State	Comments	Config
cdto_inc[23:16]	7:0	R	0	status bits 23:16 of the 30-bit-wide chroma sync DTO increment.	

Register::CDTO_INC_STATUS2 0xC6					
Name	Bits	Read/Write	Reset State	Comments	Config
cdto_inc[15:8]	7:0	R	0	status bits 15:8 of the 30-bit-wide chroma sync DTO increment.	

Register::CDTO_INC_STATUS1 0xC7					
Name	Bits	Read/Write	Reset State	Comments	Config
cdto_inc[7:0]	7:0	R	0	status bits 7:0 of the 30-bit-wide chroma sync DTO increment.	

Register::AGC_DGAIN_STATUS2 0xC8					
Name	Bits	Read/Write	Reset State	Comments	Config
agc_dgain[11:8]	7:0	R	0	digital AGC gain value[11:8].	

Register::AGC_DGAIN_STATUS1 0xC9					
Name	Bits	Read/Write	Reset State	Comments	Config
agc_dgain[7:0]	7:0	R	0	digital AGC gain value[7:0].	

Register::CMAG_STATUS 0xCA					
Name	Bits	Read/Write	Reset State	Comments	Config

status_cmag	7:0	R	0	chroma magnitude.	
-------------	-----	---	---	-------------------	--

Register::CGAIN_STATUS2 0xCB					
Name	Bits	Read/Write	Reset State	Comments	Config
reserved	7:6	--	--	reserved.	
status_cgain[13:8]	5:0	R	0	high order bits of the chroma gain.	

Register::CGAIN_STATUS1 0xCC					
Name	Bits	Read/Write	Reset State	Comments	Config
status_cgain[7:0]	7:0	R	0	low order bits of the chroma gain.	

Register::CORDIC_FREQ_STATUS 0xCD					
Name	Bits	Read/Write	Reset State	Comments	Config
status_cordiq_freq	7:0	R	0	SECAM cordic frequency.	

Register::NOISE_STATUS 0xCE					
Name	Bits	Read/Write	Reset State	Comments	Config
status_noise	7:0	R	0	indicates how noisy the signal is. Larger values indicate noisier signals. This register is used in conjunction with programmable register 05h, "noise_thresh" and status bit 3C.3h, "noisy".	

Reset Register

Register::VIDEO_RESET_REGISTER 0xCF					
Name	Bits	Read/Write	Reset State	Comments	Config
reserved	7:1	--	--	reserved	
soft_reset	0	R/W	0	soft reset	

Auto Mode State Machine Registers.

Register::palm_flag_compensation1 0xD0					
Name	Bits	Read/Write	Reset State	Comments	Config
reserved	7:6	-	--	Reserved.	
palm_atone_counter	5:0	R/W	0x10	palm flag compensation counter.	

Register::palm_flag_compensation2 0xD1					
Name	Bits	Read/Write	Reset State	Comments	Config
palm_atone_threshold	7:0	R/W	0	palm flag compensation threshold. The value of register must be added by 200. 0 + 200*1 = 200	

Register::manual_mode 0xD2					
Name	Bits	Read/Write	Reset State	Comments	Config
auto_mode_en	7	R/W	1	Auto mode detection enable register. When bit6 is 0, reference to this bit. 1: enable. Use auto mode. 0: disable. Use manual mode.	
auto_625only_en	6	R/W	0	Auto 625-only enable bit. 1: enable auto 625 detection only, no matter bit7 is 0 or 1. 0: reference to bit7.	
Auto_burst_switch_625only	5	R/W	0	Auto 625 only mode switch, when burst detection is 0 0: disable 1: enable	
reserved	4	--	--	reserved	
state_machine_reset	3	R/W	0	Reset auto mode state machine. 1: reset 0: normal	
manual_mode_select	2:0	R/W	0	Select a mode when bit3 is 0. 0: ntsc. 1: palm. 2: ntsc50. 3: paln. 4: ntsc443. 5: pal60. 6: pali. 7: secam.	

Register::mode_detection_status 0xD3					
Name	Bits	Read/Write	Reset State	Comments	Config
reserved	7	-	-	reserved	
set_mode_status	6:4	R	0	Setting mode status. 0: ntsc. 1: palm.	

				2: ntsc50. 3: paln. 4: ntsc443. 5: pal60. 6: pali. 7: secam.	
reserved	3	-	-	reserved	
decision_mode_status	2:0	R	0	Auto mode detection result. 0: ntsc. 1: palm. 2: ntsc50. 3: paln. 4: ntsc443. 5: pal60. 6: pali. 7: secam.	

Register::statistic_and_disable_mode 0xD4					
Name	Bits	Read/Write	Reset State	Comments	Config
disable_mode_en	7	R/W	0	Disable mode enable register. 1: enable. 0: disable.	
disable_mode	6	R/W	0	Disable 625 or 525 mode when bit7 is 1. 1: disable 625 input. 0: disable 525 input.	
statistic_number	5:0	R/W	4	Number of frame to delay and calculate statistic, when vcr or noisy happens. Default 4 means 4 frames.	

Register::prefer_mode 0xD5					
Name	Bits	Read/Write	Reset State	Comments	Config
prefer_ntsc50_palm	7	R/W	0	Prefer ntsc50 or palm when bit3 is 1. 1: ntsc50. 0: palm.	
prefer_ntsc443_pal60	6	R/W	0	Prefer ntsc443 or pal60 when bit2 is 1. 1: ntsc443. 0: pal60.	
prefer_secam_pali	5	R/W	0	Prefer secam or pali when bit1 is 1. 1: secam. 0: pali.	
prefer_ntsc_palm	4	R/W	0	Prefer ntsc or palm when bit0 is 1. 1: ntsc. 0: palm.	
prefer_ntsc50_palm_en	3	R/W	0	Prefer ntsc50 or palm enable register. 1: enable. 0: disable.	
prefer_ntsc443_pal60_en	2	R/W	0	Prefer ntsc443 or pal60 enable register. 1: enable. 0: disable.	
prefer_secam_pali_en	1	R/W	0	Prefer secam or pali enable register. 1: enable. 0: disable.	
prefer_ntsc_palm	0	R/W	0	Prefer ntsc or palm enable register.	

_en				1: enable. 0: disable.	
-----	--	--	--	---------------------------	--

Register::state_machine_fix_mode 0xD6					
Name	Bits	Read/Write	Reset State	Comments	Config
Fix_625flag_en	7	R/W	0	In auto mode state machine, enable fix 625 flag mode 0 : disable, use real 625 flag 1 : enable, reference to bit3	
Fix_443flag_en	6	R/W	0	In auto mode state machine, enable fix 443 flag mode 0 : disable, use real 443 flag 1 : enable, reference to bit2	
Fix_palorflag_en	5	R/W	0	In auto mode state machine, enable fix palor flag mode 0 : disable, use real palor flag 1 : enable, reference to bit1	
Fix_secamflag_en	4	R/W	0	In auto mode state machine, enable fix secam flag mode 0 : disable, use real secam flag 1 : enable, reference to bit0	
Fix_625_h	3	R/W	0	If bit7 is 1, fix 625 flag in auto mode state machine 0 : low 1 : high	
Fix_443_h	2	R/W	0	If bit6 is 1, fix 443 flag in auto mode state machine 0 : low 1 : high	
Fix_palor_h	1	R/W	0	If bit5 is 1, fix palor flag in auto mode state machine 0 : low 1 : high	
Fix_secam_h	0	R/W	0	If bit4 is 1, fix secam flag in auto mode state machine 0 : low 1 : high	

Register::zoran_register_enable 0xD7					
Name	Bits	Read/Write	Reset State	Comments	Config
Hactivestartreg_en	7	R/W	0	Enable register from zoran. Include reg_hactive_start.. 1: enable. 0: disable.	
Hpixelreg_en	6	R/W	0	Enable register from zoran. Include reg_hpixel. 1: enable. 0: disable.	
Colourmodereg_en	5	R/W	0	Enable register from zoran. Include reg_colour_mode. 1: enable. 0: disable.	
Hagcreg_en	4	R/W	0	Enable register from zoran. Include reg_hagc. 1: enable. 0: disable.	
vline625reg_en	3	R/W	0	Enable register from zoran. Include reg_vline_625. 1: enable. 0: disable.	
Cdtomem_reg_en	2	R/W	0	Enable register from zoran. Include reg_cdto_inc. 1: enable. 0: disable.	

Vsyncreg_en	1	R/W	0	Enable register from zoran. Include reg_vactive_start, reg_vactive_height. 1: enable. 0: disable.	
Ped_reg_en	0	R/W	0	Enable register from zoran. Include reg_ped and reg_cagc_en. 1: enable. 0: disable.	

Register::auto_mode_state_machine_statistic				0xD8	
--	--	--	--	-------------	--

Name	Bits	Read/Write	Reset State	Comments	Config
switch_palo_palm_method	7:6	R/W	0	Choose pal flag for state machine, 3 methods 0 : palor flag 1 : palo flag 2 : palm flag 3 : reserved	
auto_secam_pali_method	5:4	R/W	0	Choose secam pali decision method. 4 methods 0 : secam flag 1 : pal flag 2 : pal flag is high and secam flag is low 3 : secam flag is high and pal flag is low	
Secam_flag_freq_disable	3	R/W	1	Secam flag freq condition disable. 0 : enable 1 : disable	
Statistic_multiplier	2:0	R/W	3	Auto mode state machine, statistic multiplier number.	

Address: 0xD9

Reserved

Comb Filter Configuration Register

Register::COMB_FILTER_CONFIG				0xDA	
-------------------------------------	--	--	--	-------------	--

Name	Bits	Read/Write	Reset State	Comments	Config
reserved	7	--	--	reserved	
PAL_perr	6	R/W	1	used to reduce phase-error artifacts in the comb filter's luma-path. It should be set for VCR signals. 0: off 1: on	
PAL_perr_auto_en	5	R/W	0	turn on the PAL_perr when VCR signals is detected.	
reserved	4:2	--	--	reserved	
PALsw_level	1:0	R/W	2	determine how many incorrect lines are used for the PAL switch circuit before switching. Use a higher level for noisy signals.	

Comb Filter Threshold Registers

Register::COMB_FILTER_THRESHOLD1				0xDB	
---	--	--	--	-------------	--

Name	Bits	Read/Write	Reset State	Comments	Config
noise_ntsc_c	7:0	R/W	0x07	used to tune the noise_threshold used by the comb filter for NTSC.	

Register::COMB_FILTER_THRESHOLD2			0xDC		
---	--	--	-------------	--	--

Name	Bits	Read/Write	Reset State	Comments	Config
noise_pal_c	7:0	R/W	0x20	used to tune the noise_threshold used by the comb filter for PAL.	

Register::COMB_FILTER_THRESHOLD3			0xDD		
---	--	--	-------------	--	--

Name	Bits	Read/Write	Reset State	Comments	Config
noise_phase_c	7:0	R/W	0x03	used to tune the noise_threshold used by the chroma comb filter.	

Register::COMB_FILTER_THRESHOLD4			0xDE		
---	--	--	-------------	--	--

Name	Bits	Read/Write	Reset State	Comments	Config
noise_phase_y	7:0	R/W	0x10	used to tune the noise_threshold used by the luma comb filter	

Address: 0xDF

Reserved

2D YC Separation Registers

Register::YC_SEP_CONTROL			0xE0		
---------------------------------	--	--	-------------	--	--

Name	Bits	Read/Write	Reset State	Comments	Config
reserved	7:3	--	--		
adaptive_mode	2:0	R/W	0	adaptive_mode: select modes for the composite signal's luma (Y) and chroma (C) separation before color demodulation. 000: fully adaptive comb (2-D adaptive comb) :Y 1/2/3 C 1/2/3 010: -- 010: 5-tap adaptive comb filter (PAL mode only) :Y 1/3/5 C 1/3/5 011: basic luma notch filter mode (for very noisy and unstable pictures) (不經過 line buffer 的結果) 100: Y 2/3/4 C 1/3/5 101: --- 110: 5-tap hybrid adaptive comb filter (PAL mode only) : Y 1/3/5 C 2/3/4	

Register::BPF_BW_SEL_Y			0xE1		
-------------------------------	--	--	-------------	--	--

Name	Bits	Read/Write	Reset State	Comments	Config
reserved	7	--	--	reserved	
wide_bpf_sel_y	6:4	R/W	4	000: 0.65Mhz (Coefficient: [-8, 0, 17, 0, -25, 0, 28, 0, -25, 0, 17,	

				0,-8) 001: 0.8Mhz (Coefficient: [-2, 0, 13, 0, -30, 0, 38, 0, -30, 0, 13, 0, -2]) 010: 1.0Mhz (Coefficient: [3, 0, 6, 0, -35, 0, 52, 0, -35, 0, 6, 0, 3]) 011: 1.3Mhz (Coefficient: [3, 0, 3, 0, -35, 0, 58, 0, -35, 0, 3, 0, 3]) 100: 1.5Mhz (Coefficient: [4, 0, 1, 0, -36, 0, 62, 0, -36, 0, 1, 0, 4]) 101: 1.8Mhz (Coefficient: [6, 0, -3, 0, -38, 0, 70, 0, -38, 0, -3, 0, 6]) 110: 2.1Mhz (Coefficient: [-2, 0, -13, 0, -31, 0, 88, 0, -31, 0, -13, 0, -2]) 111: 2.6MHz(Coefficient: [-12, 0, -17, 0, -20, 0, 98, 0, -20, 0, -17, 0, -12])	
reserved	3	--	--	reserved	
narrow_bpf_sel_y	2:0	R/W	3	000: 0.65Mhz (Coefficient: [-8, 0, 17, 0, -25, 0, 28, 0, -25, 0, 17, 0, -8]) 001: 0.8Mhz (Coefficient: [-2, 0, 13, 0, -30, 0, 38, 0, -30, 0, 13, 0, -2]) 010: 1.0Mhz (Coefficient: [3, 0, 6, 0, -35, 0, 52, 0, -35, 0, 6, 0, 3]) 011: 1.3Mhz (Coefficient: [3, 0, 3, 0, -35, 0, 58, 0, -35, 0, 3, 0, 3]) 100: 1.5Mhz (Coefficient: [4, 0, 1, 0, -36, 0, 62, 0, -36, 0, 1, 0, 4]) 101: 1.8Mhz (Coefficient: [6, 0, -3, 0, -38, 0, 70, 0, -38, 0, -3, 0, 6]) 110: 2.1Mhz (Coefficient: [-2, 0, -13, 0, -31, 0, 88, 0, -31, 0, -13, 0, -2]) 111: 2.6MHz(Coefficient: [-12, 0, -17, 0, -20, 0, 98, 0, -20, 0, -17, 0, -12])	

Register::BPF_BW_SEL_C				0xE2	
Name	Bits	Read/Write	Reset State	Comments	Config
reserved	7	--	--	reserved	
wide_bpf_sel_c	6:4	R/W	6	000: 0.65Mhz (Coefficient: [-8, 0, 17, 0, -25, 0, 28, 0, -25, 0, 17, 0, -8]) 001: 0.8Mhz (Coefficient: [-2, 0, 13, 0, -30, 0, 38, 0, -30, 0, 13, 0, -2]) 010: 1.0Mhz (Coefficient: [3, 0, 6, 0, -35, 0, 52, 0, -35, 0, 6, 0, 3]) 011: 1.3Mhz (Coefficient: [3, 0, 3, 0, -35, 0, 58, 0, -35, 0, 3, 0, 3]) 100: 1.5Mhz (Coefficient: [4, 0, 1, 0, -36, 0, 62, 0, -36, 0, 1, 0, 4]) 101: 1.8Mhz (Coefficient: [6, 0, -3, 0, -38, 0, 70, 0, -38, 0, -3, 0, 6]) 110: 2.1Mhz (Coefficient: [-2, 0, -13, 0, -31, 0, 88, 0, -31, 0, -13, 0, -2]) 111: 2.6MHz(Coefficient: [-12, 0, -17, 0, -20, 0, 98, 0, -20, 0, -17, 0, -12])	
reserved	3	--	--	reserved	

narrow_bpf_sel_c	2:0	R/W	0	000: 0.65Mhz (Coefficient: [-8, 0, 17, 0, -25, 0, 28, 0, -25, 0, 17, 0, -8]) 001: 0.8Mhz (Coefficient: [-2, 0, 13, 0, -30, 0, 38, 0, -30, 0, 13, 0, -2]) 010: 1.0Mhz (Coefficient: [3, 0, 6, 0, -35, 0, 52, 0, -35, 0, 6, 0, 3]) 011: 1.3Mhz (Coefficient: [3, 0, 3, 0, -35, 0, 58, 0, -35, 0, 3, 0, 3]) 100: 1.5Mhz (Coefficient: [4, 0, 1, 0, -36, 0, 62, 0, -36, 0, 1, 0, 4]) 101: 1.8Mhz (Coefficient: [6, 0, -3, 0, -38, 0, 70, 0, -38, 0, -3, 0, 6]) 110: 2.1Mhz (Coefficient: [-2, 0, -13, 0, -31, 0, 88, 0, -31, 0, -13, 0, -2]) 111: 2.6MHz(Coefficient: [-12, 0, -17, 0, -20, 0, 98, 0, -20, 0, -17, 0, -12])	
-------------------------	-----	-----	---	--	--

Register::ADAP_BPF_C_TH1 0xE3					
Name	Bits	Read/Write	Reset State	Comments	Config
xc_area1_thr	7:0	R/W	0x0C	Major region threshold for Chroma adaptive BPF detection	

Register::ADAP_BPF_C_TH2 0xE4					
Name	Bits	Read/Write	Reset State	Comments	Config
xc_area2_thr	7:0	R/W	0x14	Minor region threshold for Chroma adaptive BPF detection	

Register::ADAP_BPF_C_TH3 0xE5					
Name	Bits	Read/Write	Reset State	Comments	Config
c_uniform2_thr	7:0	R/W	0x0c	Uniform region threshold 2 for Chroma adaptive BPF detection	

Register::ADAP_BPF_C_TH4 0xE6					
Name	Bits	Read/Write	Reset State	Comments	Config
c_uniform1_thr	7:5	R/W	0x04	Uniform region threshold 1 for Chroma adaptive BPF detection	
c_uniform3_thr	4:0	R/W	0x04	Uniform region threshold 3 for Chroma adaptive BPF detection	

Register::ADAP_BPF_Y_TH1 0xE7					
Name	Bits	Read/Write	Reset State	Comments	Config
xl_area_thr	7:0	R/W	0x08	Threshold for Ychroma adaptive BPF detection	

Register::ADAP_BPF_Y_TH2 0xE8					
Name	Bits	Read/Write	Reset State	Comments	Config
xc_sel_gain	7:6	R/W	0	Cross color region gain level 00 : 1 01 : 0.875 10 : 0.75	

pal_alpha_lut	5:4	R/W	0x01	11 : 0.625 Blending table for pal 00: original table 01: new table 10 : reserved 11: reserved	
y_uniform_thr	3:0	R/W	3	Uniform region threshold for Ychroma adaptive BPF detection	

Register::ADAP_BPF_Y_TH3 0xE9					
Name	Bits	Read/Write	Reset State	Comments	Config
Malpha_c_divide	7	R/W	0		
r2_sel					
malpha_y_divide	6	R/W	0		
r2_sel					
malpha_y_en	5	R/W	0	Malpha for Y	
malpha_y	4	R/W	0	malpha_y value when malpha_y_en=1 1 : Malpha_y =16 0 : Malpha_y = 0	
malpha_c_en	3	R/W	0	Malpha for C	
malpha_c	2	R/W	0	malpha_y value when malpha_c_en=1 1 : Malpha_c =16 0 : Malpha_c = 0	
yalpha_en	1	R/W	0	yalpha enable	
yalpha	0	R/W	0	yalpha value when yalpha_en=1 1 : yalpha =16 0 : yalpha = 0	

Register::YC_BW_CTRL 0xEA					
Name	Bits	Read/Write	Reset State	Comments	Config
reserved	7	--	--	reserved	
pal_demod_sel	6	R/W	0	select the demodulation filter before chroma low pass filter. 0: [1 1]/2 1: [1 2 1]/4	
reserved	5:4	--	--	reserved	
chroma_vlpf_en	3	R/W	0	chroma vertical low pass filter enable. 0: disabled 1: vertical low pass filter	
chroma_bw_lo	2:0	R/W	1	set the chroma low pass filter to wide or narrow. for NTSC: (with 0 between each coefficients) 000 Bypass mode 001 3.6Mhz [0 0 0 0 0 1 1 0 0 0 0 0] 010 2.9Mhz [0 1 -7 -11 36 109 109 36 -11 -7 1 0] 011 2.4Mhz [0 0 -18 4 51 91 91 51 4 -18 0 0] 100 2.1Mhz [0 -3 -6 6 45 86 86 45 6 -6 -3 0] 101 1.8Mhz [-5 -7 0 21 49 70 70 49 21 0 -7	

				-5]	
				110 1.2Mhz [-2 2 11 25 41 51 51 41 25 11 2	
				-2]	
				111 0.8Mhz [3 8 16 26 35 40 40 35 26 16 8	
				3]	

Register::2D_DEBUG_MODE				0xEB	
Name	Bits	Read/Write	Reset State	Comments	Config
reserved	7	--	--	reserved	
mden_plus_sel	6:5	R/W	00	00: 2610 case 01: enable LPF decision 10: disable Mden_plus 11: enable Mden_plus	
debug_mode_2d_en	4	R/W	0	2D debug mode enable	
debug_mode_2d	3:0	R/W	0	0000 : narrow BPF region for Cchroma 0001 : XC region 0010 : uniform region for Cchroma 0011 : wide BPF region for Ychroma 0100 : XL region 0101 : uniform region for Ychroma 0110 : Malpha_y 0111 : Malpha_c 1000 : Yalpha 1001 : Calpha 1010 : no_hor_tmp=1 1011 : hortendency=1 1100 : 1d blend 1101 : BW 1110 : h2v	

Register::RESOL_LP_THR				0xEC	
Name	Bits	Read/Write	Reset State	Comments	Config
reso_lp_thr	7:0	R/W	0x14		

Register::Envelope_THR				0xED	
Name	Bits	Read/Write	Reset State	Comments	Config
reserved	7	--	--		
horcrossluma_en	6	R/W	0	Enable horizontal decision when horcrossluma_en=1	
envelope_thr	5:0	R/W	4		

Register::Comb_filter_THR5				0xEE	
Name	Bits	Read/Write	Reset State	Comments	Config
horcrossluma_mode	7:5	R/W	0	horizontal decision mode when horcrossluma_en=1 000 : mden<4 001 : mnom_vdy>mden*2	

				010 : mnom_vdy>mden 011 : mnom_vdy>mden/2 100 : reserved	
noise_ntsc_c2_en	4	R/W	0	Only for PAL mode to reduce Xluma. 0 : turn off 1 : turn on noise_ntsc_c2 function	
noise_ntsc_c2	3:0	R/W	7	Used to tune the noise_threshold2 used by the comb filter for PAL	

Address: 0xEF

Reserved

Register::BW_detection 0xF0					
Name	Bits	Read/Write	Reset State	Comments	Config
bw_gain_sel	7:6	R/W	0	Gain level selection for B&W diagonal region 00:1 01:0.75 10:0.5 11:0.25	
bw_detect_thr	5:0	R/W	0x10	Threshold for B&W detection. The operating results under this threshold will be regarded as B&W regions.	

Register::BW_edge_thr 0xF1					
Name	Bits	Read/Write	Reset State	Comments	Config
Bw_edge_thr	7:0	R/W	0x20	Threshold for B&W edge detection The operating results over this threshold will be regarded as B&W edge regions.	

Register::2d_alpha_mod_enable 0xF2					
Name	Bits	Read/Write	Reset State	Comments	Config
1d_blend_enable	7	R/W	1	Enables the 1d blending	
alpha_mode	6	R/W	1	Enables the alpha modification	
lut_sel_y	5	R/W	0	Y Blending LUT Selection 0: Zoran PAL LUT 1: Zoran NTSC LUT	
lut_sel_c	4	R/W	0	C Blending LUT Selection 0: Zoran PAL LUT 1: Zoran NTSC LUT	
reserved	3	--	--		
h2v_coring_thr	2:0	R/W	2	Sets the h2v coring level	

Register::H2V_coring_thr 0xF3					
Name	Bits	Read/Write	Reset State	Comments	Config
reserved	7	--	--		
h2v_cvbs_coring_thr	6:4	R/W	2	Sets the h2v cvbs coring level.	
h2v_bw_color_gain	3:0	R/W	3	Sets the h2v B&W-Color comparison ratio. The lower this value is, the result is more Y-blended.	

Register::H2V_y_noise_thr 0xF4					
Name	Bits	Read/Write	Reset	Comments	Config

		Write	State	
h2v_y_noise_thr	7:0	R/W	8	Noise threshold for h2v Y signal.

Register::H2V_cvbs_noise_thr 0xF5					
Name	Bits	Read/Write	Reset State	Comments	Config
h2v_cvbs_noise_thr	7:0	R/W	8	Noise threshold for h2v cvbs signal.	

Register::H2V_blend_ratio 0xF6					
Name	Bits	Read/Write	Reset State	Comments	Config
reserved	7:3	--	--		
h2v_blendratio	2:0	R/W	4	Adjusts the positive shift number of h2v blending factors. The higher this value is, the more 2D-approached LUT is resulted.	

Register::1D_blend_thr 0xF7					
Name	Bits	Read/Write	Reset State	Comments	Config
reserved	7	--	--		
1d_blend_thr	6:2	R/W	2	Threshold for 1d blending The operating results over this threshold will be applied with 1d blending.	
1d_bpf_sel_y	1:0	R/W	0	Y BPF selection for 1d blending	

Register::1D_blend_bpf_sel 0xF8					
Name	Bits	Read/Write	Reset State	Comments	Config
reserved	7	--	--		
1d_narrow_bpf_sel_c	6:4	R/W	0	C Narrow BPF selection for 1d blending	
reserved	3	--	--		
1d_wide_bpf_sel_c	2:0	R/W	2	C Wide BPF selection for 1d blending	

Address: 0xF9~0xFF

Reserved

Page 9 Video Decoder

Clamping/AGC Control Registers

Register::AGC_PEAK_NOMINAL				0xA0	
Name	Bits	Read/Write	Reset State	Comments	Config
reserved	7	--	--	reserved	
agc_peak_nominal	6:0	R/W	0x0a	set the luma peak white detection's AGC nominal peak white value. This value is added to 128 and then the result is multiplied by 4	

Register::AGC_PEAK_AND_GATE_CTRL				0xA1	
Name	Bits	Read/Write	Reset State	Comments	Config
agc_gate_vsync_coarse	7	R/W	1	forces coarse sync-tip and backproch gates to be used during vsync when VCRs are detected. 0: off 1: on	
agc_gate_vsync_stip	6	R/W	0	forces sync-tip clamping during vsync. 0: off 1: on	
agc_gate_kill_mode	5:4	R/W	3	method that sync-tip and backporch gates are suppressed 00: off 01: enabled – if sync-tip gate is killed, kill backproch gate 10: enabled – if sync-tip gate is killed, kill backproch gate, except during vsync 11: enabled – if sync-tip gate is killed, don't kill backporch gate	
agc_peak_en	3	R/W	1	enables the AGC peak white detector 0: disable 1: enable	
agc_peak_cntl	2:0	R/W	1	set the time constant for the AGC peak white detector	

Register::AGC_PEAK_CTRL				0xA2	
Name	Bits	Read/Write	Reset State	Comments	Config
unlock_peakrst_en	7	R/W	1	peak gain will reset to 0 when H is unlock 1: enable 0: disable	
reserved	6:2	--	--	reserved	
agc_peak_loop_gain	1:0	R/W	0	peak gain selection 00 : 1/1 (original) 01 : 1/8 10 : 1/32 11 : 1/64	

Register::VIDEO_CONTROL2				0xA3	
Name	Bits	Read/Write	Reset State	Comments	Config
hagc_field_mode	7	R/W	0	when this bit is “0”, then the gain is updated once per line, after DC clamping. When this bit is set, then the gain is only updated once per field, at the start of vertical blank. 0: off 1: on	
mv_hagc_mode	6	R/W	1	when set, automatically reduces the gain (set in register 0x04) by 25% when macro-vision encoded signals are detected. 0: off 1: on	
Dc_clamp_mode	5:4	R/W	0	sets the mode for analog front end DC clamping. 00: auto; use backporch when a signal exists; use synctip if no signal exists 01: backporch only 10: synctip only 11: off	
reserved	3:2	R/W	0	reserved	
cagc_en	1	R/W	1	enables the chroma AGC. If disabled, then the AGC target is used to drive directly the AGC gain. 0: off 1: on	
hagc_en	0	R/W	1	enables the luma/composite AGC. If disabled, then the AGC target (register 0x04h) is used to drive directly the AGC gain. 0: off 1: on	

Register::LUMA_AGC_VALUE				0xA4	
Name	Bits	Read/Write	Reset State	Comments	Config
hagc	7:0	R/W	0xdd	specifies the luma AGC target value. The gain of the AGC is modified until the horizontal sync height is equal to this value. Note that if a macro-vision signal is detected and “mv_hagc” (02.6h) is set, then this value is automatically reduced by 25%. NTSC M: 0xddh (default) NTSC J: 0xcdh PAL B, D, G, H, COMB N, SECAM: 0xdch PAL M, N: 0xddh NTSC M (MACROVISION): 0xa6h PAL B, D, G, H, I, COMB N (MACROVISION): 0xae If “hagc_en” (register 02.0h) is “0”, then “hagc” is used to directly drive the analog gain. In this case, a value of 64 represents a unity gain, 32 represents a one-half gain, and 128 denoted a double gain.	

Register::AGC_GATE_START_M				0xA5	
Name	Bits	Read/	Reset	Comments	Config

		Write	State	
reserved	7:3	--	--	reserved
agc_gate_start[10:8]	2:0	R/W	0x04	delay from the detected hsync for the rough gate generator (MSB [10:8]).

Register::AGC_GATE_START_L 0xA6					
Name	Bits	Read/Write	Reset State	Comments	Config
agc_gate_start[7:0]	7:0	R/W	0x00	delay from the detected hsync for the rough gate generator (LSB [7:0]).	

Register::AGC_GATE_WIDTH 0xA7					
Name	Bits	Read/Write	Reset State	Comments	Config
reserved	7	--	--	reserved	
agc_gate_width	6:0	R/W	0x40	width of the rough gates	

Register::AGC_BP_DELAY 0xA8					
Name	Bits	Read/Write	Reset State	Comments	Config
agc_bp_delay	7:0	R/W	0x64	set the time delay from the sync tip gate to the backporch gate for the rough gate generator.	

Register::CLAMPAGC_COMPLUMA_NEW_THRESHOLD2 0xA9					
Name	Bits	Read/Write	Reset State	Comments	Config
reserved	7:6	--	--	Reserved.	
clampagc_under_th2	5:0	R/W	0x3F	Threshold2 for clampagc_compluma_new.	

Register::CLAMPAGC_COMPLUMA_NEW_THRESHOLD1 0xAA					
Name	Bits	Read/Write	Reset State	Comments	Config
under_flag	7	R	0	1: under threshold occurs. 0: normal	
under_flag_wclr_out	6	R/W	0	Write 1 to clear	
reserved	5:4	--	--	Reserved.	
clampagc_under_th1	3:0	R/W	0x00	threshold for clampagc_compluma_new. clampagc_compluma_new under this threshold will decrease dgain to avoid data underflow.	

Register::CLAMPAGC_COMPLUMA_NEW_CONTROL 0xAB					
Name	Bits	Read/Write	Reset State	Comments	Config
clampagc_under_cntl	7:2	R/W	0	Set the time constant for the agc bottom gain detector.	

clampage_under_en	1	R/W	1	clampage_under_th on/off 0: off 1: on	
blank_vid_offset	0	R/W	1	Set the interna_blank_vid_level value. 0: 192 1: 240	

Register::VSYNC_AGC_MIN 0xAC					
Name	Bits	Read/Write	Reset State	Comments	Config
reserved	7	--	--	Reserved.	
vsync_agc_min	6:0	R/W	0x6C	defines the number of half-lines before the vsync that the AGC, SYNCTIP, and BACKPORCH gates are disabled. (df: -20)	

Register::VSYNC_AGC_LOCKOUT_END 0xAD					
Name	Bits	Read/Write	Reset State	Comments	Config
vsync_clamp_mode	7:6	R/W	0x02	control DC clamping during the vertical blanking interval. 00: disabled 01: enabled 10: enabled except for noisy signals 11: enabled only for clean VCR signals	
vsync_agc_max	5:0	R/W	0x10	defines the number of half-lines after the vsync that the AGC, SYNCTIP, and BACKPORCH gates are re-enabled.	

Address : 0xAE ~0xAF

Reserved

Register::CHARGE_PUMP_DELAY_CONTROL 0xB0					
Name	Bits	Read/Write	Reset State	Comments	Config
cpump_adjust_delay	7:2	R/W	0x0A	delay, relative to charge-pump pulses, before adjustment, used to Compensate for possible visible artifacts caused by charge-pump pulses, is applied.	
cpump_adjust_polarity	1	R/W	0	polarity of adjustment used to compensate for possible visible Artifacts caused by charge-pump pulses.	
cpump_delay_en	0	R/W	0	enable delay of charge-pump up/down pulses. 0: disabled 1: enabled	

Register::CHARGE_PUMP_ADJUSTMENT 0xB1					
Name	Bits	Read/Write	Reset State	Comments	Config
cpump_adjust	7:0	R/W	0xC8	used to compensate for possible visible artifacts caused by charge-pump pulses.	

Register::CHARGE_PUMP_DELAY 0xB2					
Name	Bits	Read/Write	Reset State	Comments	Config
cpump_delay	7:0	R/W	0xB9	If "cpump_delay_en=1", then the charge pump up/down pulses are delayed by "4xcpump_delay" output pixels.	

Address : 0xB3

Reserved

Chroma Loop Control Registers

Register::CHROMA_AGC						0xB4	
Name	Bits	Read/Write	Reset State	Comments	Config		
Cagc	7:0	R/W	0x8A	set the chroma AGC target.			

Register::CHROMA_KILL						0xB5	
Name	Bits	Read/Write	Reset State	Comments	Config		
user_kill_mode	7:6	R/W	0	00: auto hardware chroma kill 01: forces chroma kill on 10: forces chroma kill off 11: reserved			
VBI_kill	5	R/W	0	chroma is killed during VBI. 0: off 1: on			
hlock_kill	4	R/W	0	chroma is killed whenever horizontal lock is lost. 0: off 1: on			
chroma_kill	3:0	R/W	0x7	set the chroma kill level.			

Register::CHROMA_LOCK_CONFIG						0xB6	
Name	Bits	Read/Write	Reset State	Comments	Config		
lose_chromalock_count	7:4	R/W	0x6	used to tune the chromakill, higher values are more sensitive to losing lock.			
lose_chromalock_level	3:1	R/W	0x5	set the level for chromakill.			
lose_chromalock_ckill	0	R/W	1	when set, chroma is killed whenever chromalock is lost.			

Register::CHROMA_LOOPFILTER_GAIN						0xB7	
Name	Bits	Read/Write	Reset State	Comments	Config		
cnew_gate_en	7	R/W	1	New burst gate enable. For 5 complete sin wave. This gate is only available when fix burst gate is set.			
reserved	6:2	--	--	Reserved.			
cage_igain	1:0	R/W	0	Cage loopfilter I-gain value. The cage responds more slowly when the smaller gain value is set . 00 : 1 01 : 1/4 10 : 1/16 11 : 1/64			

Register::CHROMA_LOOPFILTER_STATE						0xB8	
Name	Bits	Read/Write	Reset State	Comments	Config		
reserved	7:4	--	--	Reserved.			
cstate	3:1	R/W	5	sets the chroma loopfilter bandwidth state, larger state has a slower response.			
fixed_cstate	0	R/W	0	when set, fixes the state of chroma loopfilter to cstate.			

Register::CHROMA_AUTOPOS				0xB9	
Name	Bits	Read/Write	Reset State	Comments	Config
reserved	7	--	--	reserved	
chroma_burst5or10	6	R/W	0	selects the burst gate width 0: 5 sub-carrier clock cycles 1: 10 sub-carrier clock cycles	
fixed_burstgate	5	R/W	1	this bit disables the burst gate auto-position. The manual burstgate window position is defined by the burst_gate_start (0x2c) and burst_gate_end (0x2d) register. 0: off 1: on 1: on	
cautopos	4:0	R/W	0x0c	set the chroma burst gate position relative to the auto center position	

Address : 0xBA ~ 0xBF

Reserved

Realtek Confidential for GM Only

HPLL Control Registers

Register::LOCK_COUNT 0xC0					
Name	Bits	Read/Write	Reset State	Comments	Config
locked_count_noisy_max	7:4	R/W	0x07	set the max value of the hlock sensor for noisy signals. 8 is added to the value.	
locked_count_clean_max	3:0	R/W	0x04	set the max value of the hlock sensor for clean signals. 8 is added to the value.	

Register::H_LOOP_MAXSTATE 0xC1					
Name	Bits	Read/Write	Reset State	Comments	Config
hlock_vsync_mode	7:6	R/W	0x03	control hsync locking during vsync. 00: disabled 01: enabled 10: enable except for noisy signals 11: enable only for clean VCR signals	
hstate_fixed	5	R/W	0	forces the state machine to remain in the state set in "hstate_max". 0: off 1: on	
disable_hfine	4	R/W	0	0: off 1: disables the fine mode of the HPLL phase comparator	
hstate_unlocked	3	R/W	1	0: off 1: sets the state when unlocked	
hstate_max	2:0	R/W	0x03	set the maximum state for the horizontal PLL state machine. The range of this register is 0 to 5, inclusive. Higher states have a finer PLL control. Values of "0" and "1" should not programmed into this register. If "hstate_fixed" is set, then this register is used to force the state.	

Register::CLAMPAGC_CTRL0 0xC2					
Name	Bits	Read/Write	Reset State	Comments	Config
fine_src_sel	7	R/W	1	the source selection for gate finding when fine mode. 0: low pass filter data 1: original data	
coarse_src_sel	6	R/W	0	the source selection for gate finding when coarse mode. 0: low pass filter data 1: original data	
fine_gate_sel	5	R/W	1	the gate selection when fine mode. 0: coarse gate 1: fine gate	
gate_end_thresh	4:0	R/W	0x0a	threshold at which the rough gate generator ends the gate. The real value is multiplied by 64.	

Register::CLAMPAGC_NEW_SYNC_START					0xC3	
Name	Bits	Read/Write	Reset State	Comments	Config	
reserved	7	--	--	reserved		
coarse_sync_start	6:0	R/W	0x08	the new coarse sync gate start position setting.		

Register::CLAMPAGC_NEW_SYNC_END					0xC4	
Name	Bits	Read/Write	Reset State	Comments	Config	
coarse_sync_end	7:0	R/W	0x38	the new coarse sync gate end position setting.		

Register::CLAMPAGC_NEW_BACKPORCH_START					0xC5	
Name	Bits	Read/Write	Reset State	Comments	Config	
agc_trailing_sel	7	R/W	1	gate_trailing pulse selection for noisy and clamping block. 0: old one 1: new one		
coarse_backporch_start	6:0	R/W	0x28	the new coarse backporch gate start position setting.		

Register::CLAMPAGC_NEW_BACKPORCH_END					0xC6	
Name	Bits	Read/Write	Reset State	Comments	Config	
coarse_backporch_end	7:0	R/W	0x58	the new coarse backporch gate end position setting.		

Register::HDETECT_PHASE_SEL					0xC7	
Name	Bits	Read/Write	Reset State	Comments	Config	
reserved	7:6	--	--	reserved.		
lpfsync_force_blank_en	5	R/W	0	Only the hblank data passes the lowpass filter 0 : disable 1 : enable		
nosignal_hlock_check_en	4	R/W	1	No signal flag is low when hlock is high 0 : disable 1 : enable		
agc_clamping_trailing_sel	3	R/W	1	clamping position selection. 0: sgate_trailing 1: depends on original setting		
Killgate_sel	2	R/W	1	The data selection for killgate decision 0: original data 1: low pass filter data for new hpll setting		
coarse_phase_sel	1	R/W	0	coarse phase difference measurement. 0: old approach (falling+rising-offset) 1: new approach (falling)		
fine_phase_sel	0	R/W	0	fine phase difference measurement. 0: old approach (falling data – rising data) 1: new approach (falling data – middle point)		

Register::HDETECT_COUNTER_TIP_START					0xC8	
Name	Bits	Read/Write	Reset State	Comments	Config	
lsync_tip_start	7:0	R/W	0	predict the start point of LPF sync tip.		

Register::HDETECT_COUNTER_TIP_END					0xC9	
Name	Bits	Read/Write	Reset State	Comments	Config	
lsync_tip_end	7:0	R/W	0	predict the end point of LPF sync tip.		

Register::HDETECT_COUNTER_BACKPORCH_START					0xCA	
Name	Bits	Read/Write	Reset State	Comments	Config	
lporch_start	7:0	R/W	0	predict the start point of LPF backporch.		

Register::HDETECT_COUNTER_BACKPORCH_END					0xCB	
Name	Bits	Read/Write	Reset State	Comments	Config	
lporch_end	7:0	R/W	0	predict the end point of LPF backporch.		

Register::HPLL_INTEGRAL_CTRL					0xCC	
Name	Bits	Read/Write	Reset State	Comments	Config	
reserved	7:2	--	--	reserved		
hpll_integral_rst	1	R/W	0	0: default 1: reset hpll integral to 0 when h unlock.		
hpll_integral_ext	0	R/W	0	0: default 1: hpll integral clamp extend 1 bit.		

Register::HDETECT_PHASE_ERR_STATUS2					0xCD	
Name	Bits	Read/Write	Reset State	Comments	Config	
reserved	7:6	--	0	reserved		
hphase_err_statuses[13:8]	5:0	R	0	status bits [13:8] of the 14-bit-wide phase error status of hdetect		

Register::HDETECT_PHASE_ERR_STATUS1					0xCE	
Name	Bits	Read/Write	Reset State	Comments	Config	
hphase_err_statuses[7:0]	7:0	R	0	status bits [7:0] of the 14-bit-wide phase error status of hdetect		

Address : 0xCF

Reserved

Horizontal Sync Detection Registers

Register::HSYNC_RISING 0xD0					
Name	Bits	Read/Write	Reset State	Comments	Config
hsync_rising	7:0	R/W	0x3E	set the position of the expected hsync rising edge. The fine hsync detector uses it. The fine detector uses this time position to sample the video signal for the rising edge of the hsync.	

Register::HSYNC_PHASE_OFFSET 0xD1					
Name	Bits	Read/Write	Reset State	Comments	Config
hsync_phase_offset	7:0	R/W	0x3E	set the offset value between the coarse hsync detector and the fine hsync detector. Nominally set to 62. The course detector actually finds the middle of the hsync so we need to subtract the nominal hsync width to find the beginning of the hsync.	

Register::HSYNC_GATE_START 0xD2					
Name	Bits	Read/Write	Reset State	Comments	Config
hsync_gate_start	7:0	R/W	0x00	These bits control the PLL horizontal sync detect window for coarse sync detection. This specifies the beginning of the window.	

Register::HSYNC_GATE_END 0xD3					
Name	Bits	Read/Write	Reset State	Comments	Config
hsync_gate_end	7:0	R/W	0x80	control the PLL horizontal sync detect window for coarse sync detection. This specifies the end of the window.	

Register::HSYNC_TIP_START 0xD4					
Name	Bits	Read/Write	Reset State	Comments	Config
hsync_tip_start	7:0	R/W	0xE9	control the PLL horizontal sync tip detect window used for AGC control. This specifies the beginning of the window. (default: -23)	

Register::HSYNC_TIP_END 0xD5					
Name	Bits	Read/Write	Reset State	Comments	Config
hsync_tip_end	7:0	R/W	0x0F	control the PLL horizontal sync tip detect window used for AGC control. This specifies the end of the window.	

Register::HSYNC_RISING_START 0xD6					
Name	Bits	Read/Write	Reset State	Comments	Config
hsync_rising_start	7:0	R/W	0x2D	a programmable start time of the window that looks for the rising edge of the hsync. This is used by the coarse hsync include.	

Register::HSYNC_RISING_END 0xD7					
Name	Bits	Read/Write	Reset State	Comments	Config
hsync_rising_end	7:0	R/W	0x50	a programmable end time for the window which spans across the rising-edge of the horizontal sync pulse.	

Register::BACKPORCH_START 0xD8					
Name	Bits	Read/Write	Reset State	Comments	Config
backporch_start	7:0	R/W	0x22	control the backporch detect window. This specifies the beginning of the window.	

Register::BACKPORCH_END 0xD9					
Name	Bits	Read/Write	Reset State	Comments	Config
backporch_end	7:0	R/W	0x4E	control the backporch detect window. This specifies the end of the window.	

Register::HBLANK_START 0xDA					
Name	Bits	Read/Write	Reset State	Comments	Config
hblank_start	7:0	R/W	0xD6	specify the beginning of the horizontal-blank-interval window. (df=-42)	

Register::HBLANK_END 0xDB					
Name	Bits	Read/Write	Reset State	Comments	Config
hblank_end	7:0	R/W	0x4E	specify the end of the horizontal-blank-interval window.	

Register::BURST_GATE_START 0xDC					
Name	Bits	Read/Write	Reset State	Comments	Config
burst_gate_start	7:0	R/W	0x32	specify the beginning of the burst gate window. Note that this window is set to be bigger than the burst. The automatic burst position tracker finds the burst within this window.	

Register::BURST_GATE_END 0xDD					
Name	Bits	Read/Write	Reset State	Comments	Config
burst_gate_end	7:0	R/W	0x46	specify the end of the burst gate window.	

Register::HACTIVE_START 0xDE					
Name	Bits	Read/Write	Reset State	Comments	Config
hactive_start	7:0	R/W	0x82	control the active video line time interval. This specifies the beginning of active line. This register is used to center the	

				horizontal position, and should <i>not</i> be used to crop the image to a smaller size.	
--	--	--	--	---	--

Register::HACTIVE_WIDTH					0xDF	
Name	Bits	Read/Write	Reset State	Comments	Config	
hactive_width	7:0	R/W	0x50	control the active video line time interval. This specifies the width of the active line, and should not be used to crop the image to a smaller size. The value 640 is added to this register.		

Vertical Sync and Field Detection Registers

Register::VACTIVE_START					0xE0	
Name	Bits	Read/Write	Reset State	Comments	Config	
vactive_start	7:0	R/W	0x22	control the first active video line in a field. This specifies the number of half-lines from the start of a field.		

Register::VACTIVE_HEIGHT					0xE1	
Name	Bits	Read/Write	Reset State	Comments	Config	
vactive_height	7:0	R/W	0x61	control the active video height. This specifies the height by the number of half lines. The value "384" is added to this register.		

Register::VSYNC_H_MIN					0xE2	
Name	Bits	Read/Write	Reset State	Comments	Config	
reserved	7	--	--	Reserved.		
vsync_h_min	6:0	R/W	0x70	defines the number of half-lines before the vsync that the hsync detector circuit is disabled. This is to make sure that the HPLL is not confused by the equalization pulses and the broad pulses. Also in VCR trick modes the VSYNC is just one 3 line wide pulse with no hsync structure so it must be ignored.		

Register::VSYNC_H_MAX					0xE3	
Name	Bits	Read/Write	Reset State	Comments	Config	
Reserved	7	--	--	Reserved.		
vsync_h_max	6:0	R/W	0x0E	defines the number of half_lines after the vsync that the hsync detector circuit is re-enabled.		

Register::VSYNC_VBI_MIN					0xE4	
Name	Bits	Read/Write	Reset State	Comments	Config	
Reserved	7	--	--	Reserved.		
vsync_vbi_min	6:0	R/W	0x70	defines the number of half-lines before the VSYNC that VBI data is valid. (df: -16)		

Register::VSYNC_VBI_LOCKOUT_END				0xE5	
Name	Bits	Read/Write	Reset State	Comments	Config
vlock_wide_range	7	R/W	0	controls whether a wide or a narrow vertical locking range should be used.	
vsync_vbi_max	6:0	R/W	0x0E	defines the number of half-lines after the VSYNC that VBI data is valid.	

Realtek Confidential for GM Only

VSYNC PLL Registers

Register::VSYNC_CNTL		0xE6			
Name	Bits	Read/Write	Reset State	Comments	Config
vsync_cntl	7:6	R/W	0	set the vsync output mode. 00: output the vertical PLL sync, except during VCR trick modes when the directly detected vsync is used 01: output the directly detected vsync. 10: output the vertical PLL derived vsync 11: output the PLL vsync in alternate mode	
vsync_threshold	5:0	R/W	0	specifies a relative threshold to add to the slice level for the purpose of vsync detection.	

Register::VSYNC_TIME_CONST		0xE7			
Name	Bits	Read/Write	Reset State	Comments	Config
field_polarity	7	R/W	0	sets the output field polarity. 0: field=1 for odd, field = 0 for even fields 1: field=0 for odd, field = 1 for even fields	
flip_field	6	R/W	0	flips even/odd fields.	
veven_delayed	5	R/W	0	delays detection of even fields by 1 vertical line.	
vodd_delayed	4	R/W	0	delays detection of odd fields by 1 vertical line.	
field_detect_mode	3:2	R/W	0x02	control the field detection logic	
vloop_tc3	1:0	R/W	0x02	set the vertical PLL time constant 3 00: 7/8 01: 15/16 10: 1 11: 1	

Register::VSYNC_TIME_CONST2		0xE8			
Name	Bits	Read/Write	Reset State	Comments	Config
Reserved	7	--	--	reserved	
vloop_tc2	6:0	R/W	0x04	set the vertical PLL time constant 2(G2) valid values: 0 ~ 64	

Register::VSYNC_TIME_CONST1		0xE9			
Name	Bits	Read/Write	Reset State	Comments	Config
vloop_tc1	7:0	R/W	0x20	set the vertical PLL time constant 1(G1) valid values: 0 ~ 128	

Register::SERRATION_TH		0xEA			
------------------------	--	------	--	--	--

Name	Bits	Read/Write	Reset State	Comments	Config
Serration_threshold	7:0	R/W	0xB0	set the serration detection threshold (+128).	

Register::NO_SIGNAL_DEC 0xEB					
Name	Bits	Read/Write	Reset State	Comments	Config
reserved	7:3	--	0	reserved	
no_signal_dec	2:0	R/W	0x1	No signal counter decrement value. Value of 0 should be avoid	

Address : 0xEC ~ 0xEF

Reserved

Chroma DTO Registers

Register::CHROMA.DTO_INC4 0xF0					
Name	Bits	Read/Write	Reset State	Comments	Config
cdto_fixed	7	R/W	0	fixes the chroma DTO at its center frequency. 0: off 1: on	
reserved	6	--	0	reserved	
cdto_inc[29:24]	5:0	R/W	0x21	cdto_inc[29:24].	

Register::CHROMA.DTO_INC3 0xF1					
Name	Bits	Read/Write	Reset State	Comments	Config
cdto_inc[23:16]	7:0	R/W	0xf0	cdto_inc[23:16].	

Register::CHROMA.DTO_INC2 0xF2					
Name	Bits	Read/Write	Reset State	Comments	Config
cdto_inc[15:8]	7:0	R/W	0x7c	cdto_inc[15:8].	

Register::CHROMA.DTO_INC1 0xF3					
Name	Bits	Read/Write	Reset State	Comments	Config
cdto_inc[7:0]	7:0	R/W	0x1f	cdto_inc[7:0].	

Horizontal Sync DTO Registers

Register::HSYNC.DTO_INC4 0xF4					
Name	Bits	Read/Write	Reset State	Comments	Config
hdto_fixed	7	R/W	0	fixes the horizontal sync DTO at its center frequency.	

				0: off 1: on	
reserved	6	--	0	reserved	
hdto_inc[29:24]	5:0	R/W	0x20	hdto_inc[29:24].	

Register::HSYNC.DTO_INC3				0xF5	
Name	Bits	Read/Write	Reset State	Comments	Config
hdto_inc[23:16]	7:0	R/W	0x00	hdto_inc[23:16].	

Register::HSYNC.DTO_INC2				0xF6	
Name	Bits	Read/Write	Reset State	Comments	Config
hdto_inc[15:8]	7:0	R/W	0x00	hdto_inc[15:8].	

Register::HSYNC.DTO_INC1				0xF7	
Name	Bits	Read/Write	Reset State	Comments	Config
hdto_inc[7:0]	7:0	R/W	0x00	hdto_inc[7:0].	

Address : 0xF8 ~ 0xFF

Reserved

Auto Mode State Machine Table Status Registers

Register::auto_mode_table1					0xA0	
Name	Bits	Read/Write	Reset State	Comments	Config	
table_cage_en	7	R	0			
table_vline_625	6	R	0			
table_hpixel	5:4	R	0			
table_ped	3	R	0			
table_colour_mode	2:0	R	0			

Register::auto_mode_table2					0xA1	
Name	Bits	Read/Write	Reset State	Comments	Config	
table_hagc	7:0	R	0			

Register::auto_mode_table3					0xA2	
Name	Bits	Read/Write	Reset State	Comments	Config	
table_hactive_start	7:0	R	0			

Register::auto_mode_table4					0xA3	
Name	Bits	Read/Write	Reset State	Comments	Config	
table_vactive_start	7:0	R	0			

Register::auto_mode_table5					0xA4	
Name	Bits	Read/Write	Reset State	Comments	Config	
table_vactive_height	7:0	R	0			

Register::auto_mode_table6					0xA5	
Name	Bits	Read/Write	Reset State	Comments	Config	
reserved	7:6	--	--			
table_cdto[29:24]	5:0	R	0			

Register::auto_mode_table7					0xA6	
Name	Bits	Read/Write	Reset State	Comments	Config	

table_cdto[23:16]	7:0	R	0		
-------------------	-----	---	---	--	--

Register::auto_mode_table8 0xA7					
Name	Bits	Read/Write	Reset State	Comments	Config
table_cdto[15:8]	7:0	R	0		

Register::auto_mode_table9 0xA8					
Name	Bits	Read/Write	Reset State	Comments	Config
table_cdto[7:0]	7:0	R	0		

Auto Mode Flag Counter Registers

Register::625_FLAG_COUNTER 0xA9					
Name	Bits	Read/Write	Reset State	Comments	Config
625_flag_counter	7:0	R/W	0x05	625 flag counter. Field base. When vcr trick, this value must be multiplied by 2	

Register::443_FLAG_COUNTER 0xAA					
Name	Bits	Read/Write	Reset State	Comments	Config
443_flag_counter	7:0	R/W	0x32	443 flag counter. This value must be multiplied by 2 and add 100. when vcr trick is detected, this value is multiplied by 2 and add 300. When not vcr trick $100 + 50*2 = 200$ When vcr trick $200 + 50*2 = 300$	

Register::SECAM_FLAG_COUNTER 0xAB					
Name	Bits	Read/Write	Reset State	Comments	Config
secam_flag_counter	7:0	R/W	0x2d	Adjust secam flag counter number. $0 + 45 = 45$	

Register::palm_flag_counter 0xAC					
Name	Bits	Read/Write	Reset State	Comments	Config
palm_flag_counter	7:0	R/W	0x3c	palm flag counter. $0 + 60 = 60$	

Register::BURST_valid_counter 0xAD					
Name	Bits	Read/	Reset	Comments	Config

		Write	State		
Burst_valid_counter	7:0	R/W	0x50	Burst magnitude not valid counter, when bigger than counter, burst detect flag set 0. This value must be multiplied by 16 Default is $0 + 80 * 16 = 1280$	

Address : 0xAE ~ 0xAF

Reserved

Realtek Confidential for GM Only

Auto Mode Flag Adjustment Registers

Register::MIDPOINT_ADJ 0xB0					
Name	Bits	Read/Write	Reset State	Comments	Config
midpoint_adjustment	7:0	R/W	0x00	Midpoint value minus this value is the final midpoint value	

Register::freq_flag_threshold 0xB1					
Name	Bits	Read/Write	Reset State	Comments	Config
Freq_flag_threshold_tune	7:0	R/W	0x00	When 443 Mhz or secam setting, change 443 flag threshold toward positive direction. $160+0=160$, $100+x=100$.	

Register::FREQ_VALID_MAX 0xB2					
Name	Bits	Read/Write	Reset State	Comments	Config
frequency_valid_upper_limit	7:0	R/W	0xc0	Upper limit for reasonable frequency value. When secam is set, this value must be multiplied by 2 and add 400. When secam is not set, this value must add 800. Secam, $400 + 160*2 = 720$, Not secam, $800 + 160*1 = 960$	

Register::FREQ_VALID_INNER 0xB3					
Name	Bits	Read/Write	Reset State	Comments	Config
condition_enable	7	R/W	0	Enable frequency invalid condition. 0: disable 1: enable	
frequency_valid_inner_limit	6:0	R/W	0x42	Inner limit for reasonable frequency value from ± 300 (250 when secam). When secam is set, this value must be multiplied by 2. When secam is set, $0 + 66*1 = 66$, When secam is not set, $0 + 66*2 = 132$,	

Register::FREQ_VALID_MIN 0xB4					
Name	Bits	Read/Write	Reset State	Comments	Config
frequency_valid_lower_limit	7:0	R/W	0x50	Upper limit for reasonable frequency value. This value must be multiplied by 2 and add 100. $100 + 80*2 = 260$	

Register::SECAM_FLAG_COUNTER_MAX 0xB5					
Name	Bits	Read/Write	Reset State	Comments	Config
secam_flag_freq	7:0	R/W	0xa0	Secam flag counter upper condition for frequency offset. This	

uency_upper_limit				value must be multiplied by 2. 160*2 = 320. (+-320)	
-------------------	--	--	--	--	--

Register::SECAM_FLAG_COUNTER_MIN				0xB6	
Name	Bits	Read/Write	Reset State	Comments	Config
secam_flag_frequency_lower_limit	7:0	R/W	0x0d	Secam flag counter lower condition for frequency offset.	

Register::palm_flag_phase_adj				0xB7	
Name	Bits	Read/Write	Reset State	Comments	Config
palm_flag_phase_adj	7:0	R/W	0x80	palm flag phase adjustment.	

Register::BURST_LOWER_LIMIT				0xB8	
Name	Bits	Read/Write	Reset State	Comments	Config
Burst_mag_trigger	7:4	R/W	0x02	When burst flag is from 1 to 0, threshold must be added by this value.	
Burst_mag_threshold	3:0	R/W	0x04	When input burst is smaller than this threshold, burst not valid counter add 1.	

Register::BURST_MAG_CHOICE				0xB9	
Name	Bits	Read/Write	Reset State	Comments	Config
vsync_select	7	R/W	1	select vsync signal. 0: vsync_1 1: vsync_vbi	
secam_frequency_valid_enable	6	R/W	1	Enable valid_frequency_condition for secam counter. 0: disable 1: enable	
reserved	5	-	-	reserved	
Burst_noise_weighting_auto	4	R/W	1		
Burst_noise_weighting	3:0	R/W	8	Noise weighting factor for burst flag threshold. Use this value is bit 4 is 0. 0 : 2/16 1 : 4/16 2 : 6/16 3 : 7/16 4 : 8/16 5 : 9/16 6 : 10/16 7 : 11/16 8 : 12/16	

				9 : 13/16 10 : 14/16 11 : 15/16 12 : 16/16 13 : 20/16 14 : 24/16 15 : 32/16	
--	--	--	--	---	--

Register::AVG_BURST_MAG_STATUS					0xBA	
Name	Bits	Read/Write	Reset State	Comments	Config	
burst_magnitude	7:0	R	0	Average burst magnitude.		

FIFO Control Register

Register::FIFO_Ctrl					0xBB	
Name	Bits	Read/Write	Reset State	Comments	Config	
v8format_sel	7	R/W	0	Ccir656 output format select. 0 : original (follow 656 spec) 1 : decode directly from hactive/vactive.		
reserved	6:3	--	--	reserved		
ps_updn_swap	2	R/W	0	phase up/down swap 0: don't swap 1: swap		
reserved	1	--	--	reserved		
FIFO_initialization	0	R/W	0	when set, initial FIFO control state to initial state. 0: when overflow/underflow happens, FIFO R/W flag reset and return state to 0 1: when overflow/underflow happens, minus/plus FIFO R/W flag to escape overflow/underflow status		

Register::FIFO_STATUS					0xBC	
Name	Bits	Read/Write	Reset State	Comments	Config	
reserved	7:4	--	--	reserved		
FIFO_full_status	3	R	0	1: FIFO full 0: normal		
FIFO_full_status_wclr_out	2	R/W	0	Wirte 1 to clear		
FIFO_empty_status	1	R	0	1: FIFOempty 0: normal		
FIFO_empty_status_wclr_out	0	R/W	0	Wirte 1 to clear		

Register::I_GAIN_CONTROL					0xBD	
Name	Bits	Read/Write	Reset State	Comments	Config	
PLL_I_gain	7:0	R/W	0xF0	set the I control gain value, range from 0 to 255 (0 to 510).		

Register::MISC_CONTROL				0xBE	
Name	Bits	Read/Write	Reset State	Comments	Config
swallow_on_vsync	7	R/W	0	limit the swallow circuit actions only during V-sync blanking region. 0: disable 1: enable	
ndivload_en	6	R/W	1	phase swallow divider load control enable. 0: disable 1: enable	
ps_up_en	5	R/W	1	phase swallow up control enable. 0: disable 1: enable	
ps_dn_en	4	R/W	1	phase swallow down control enable. 0: disable 1: enable	
PLL_div	3:0	R/W	0xF	set the divider parameter, range from 0 to 15 (2^0 to 2^{15}).	

Register::FIFO_DEPTH_MIN_STATUS				0xBF	
Name	Bits	Read/Write	Reset State	Comments	Config
reserved	7	--	--	reserved	
FIFO_depth_min_clr	6	R/W	0	Write 1 to clear	
FIFO_depth_min_status	5:0	R	0x00	the minimal depth of FIFO after the last read.	

Register::FIFO_DEPTH_MAX_STATUS				0xC0	
Name	Bits	Read/Write	Reset State	Comments	Config
reserved	7	--	--	reserved	
FIFO_depth_max_clr	6	R/W	0	Write 1 to clear	
FIFO_depth_max_status	5:0	R	0x00	the maximum depth of FIFO after the last read..	

Register::HSYNC_PULSE_START				0xC1	
Name	Bits	Read/Write	Reset State	Comments	Config
hsync_start	7:0	R/W	0x00	set the hsync start position after the trailing of hactive signal (pixels).	

Register::HSYNC_PULSE_WIDTH				0xC2	
Name	Bits	Read/Write	Reset State	Comments	Config
hsync_width	7:0	R/W	0x40	set the hsync width (pixels).	

Register::CHROMA_HRESAMPLER_CONTROL				0xC3	
Name	Bits	Read/Write	Reset State	Comments	Config

reserved	7:2	--	--	Reserved.	
hresampler_app_sel	1	R/W	1	Fix hresample multiburst twinle dots bug. 0: disable 1: enable	
hresampler_2up	0	R/W	1	when set, upsample the chroma by 2 before going into the hresampler.	

Realtek Confidential for GM Only

SECAM Control Registers

Register::SECAM_Ctrl 0xC4					
Name	Bits	Read/Write	Reset State	Comments	Config
drdb_freq_const	7	R/W	1	for abnormal secam mode, use fixed frequency offset for compensation. 0: auto tracking 1: fixed frequency. Use dr_offset & db_offset value.	
Drdb_vlpf_en	6	R/W	0	SECAM DrDb vertical LPF enable. 1: enable 0: disable.	
reserved	5:2	--	--	Reserved.	
Secam_notch_filter	1:0	R/W	2	SECAM notch filter selection 00 : FIR filter 01 : iir filter with BW=0.7 10 : iir filter with BW=0.5 11 : iir filter with BW=0.4	

Register::SECAM_Drfreq_offset 0xC5					
Name	Bits	Read/Write	Reset State	Comments	Config
Dr_offset	7:0	R/W	0x41	This value is used to fine tune the secam black level DR value. Default = 65	

Register::SECAM_Dbfreq_offset 0xC6					
Name	Bits	Read/Write	Reset State	Comments	Config
Db_offset	7:0	R/W	0x14	This value is used to fine tune the secam black level DB value. Default = 20	

Register::SECAM_hcount_reset_ctrl 0xC7					
Name	Bits	Read/Write	Reset State	Comments	Config
secam_phase_diff_hcount_en	7	R/W	0	Secam phase_diff_hcount_en enable 0: disable 1: enable	
secam_phase_diff_hcount	6:0	R/W	0x00	If hcount < this value, the phase difference from cordic will reset to secam_phase_diff_dr/db.	

Register::Phase_diff_dr_rst 0xC8					
Name	Bits	Read/Write	Reset State	Comments	Config
secam_phase_diff_dr	7:0	R/W	0xAB	Secam dr's phase diff from cordic reset value Default = ABh	

Register::Phase_diff_db_rst					0xC9	
Name	Bits	Read/Write	Reset State	Comments	Config	
Secam_phase_diff_db	7:0	R/W	0x14	Secam db's phase diff from cordic reset value Default = 14h		

Register::DrDb_gain_table_ctrl					0xCA	
Name	Bits	Read/Write	Reset State	Comments	Config	
secam_gain_drdb_en	7	R/W	0	Secam gain drdb look up table enable 0: disable 1: enable		
secam_gain_drdb	6:0	R/W	0	Drdb threshold.		

Register::Y_gain_table_ctrl					0xCB	
Name	Bits	Read/Write	Reset State	Comments	Config	
secam_gain_y_en	7	R/W	0	Secam gain y look up table enable 0: disable 1: enable		
secam_gain_y	6:0	R/W	8	Y threshold.		

Register::secam_gain_dly					0xCC	
Name	Bits	Read/Write	Reset State	Comments	Config	
reserved	7:5	--	--	reserved		
Secam_gain_delay	4:0	R/W	0x12	Secam Y delay for dr/db gain		

Register::SECAM_gain_table_debug					0xCD	
Name	Bits	Read/Write	Reset State	Comments	Config	
secam_gain_debug_en	7	R/W	0	Secam gain debug enable 0: disable 1: enable		
secam_gain_debug	6:0	R	0	Gain value read from the gain table		

Address: 0xCE ~ 0xCF Reserved

MISC Control Registers

Register::LDPAUSE_CTRL					0xD0	
Name	Bits	Read/Write	Reset State	Comments	Config	
Ld_pause_detect	7	R	0	LD pause detected. 0: normal play. 1: LD pause detected.		
Ldp_det_en	6	R/W	1	Enable LD pause detect 0: disable.		

				1: enable.	
Ldp_switch_en	5	R/W	1	Enable 2D/3D switch when LD pause detected. 0: disable.(only detect, not switch) 1: auto switch to 2D if LD pause detected.	
ldpaus_th	4:0	R/W	0x04	The threshold is this value multiply by 32.	

Register::VCR_OPTION 0xD1					
Name	Bits	Read/Write	Reset State	Comments	Config
Coch_en	7	R/W	0	Vlpf on lpfhsyns enable for Co_channel. 1: enable 0: disable.	
reserved	6:3	--	--	reserved	
lock_h_on_no_signal	2	R/W	0	enable to lock hsync when no signal occurs and blue screen is set. 0: free run when no signal occurs and blue screen is set. 1: enable to lock hsync when no signal occurs and blue screen is set.	
disable_blue_screen_when_VCR	1	R/W	1	disable the blue screen mode when VCR is detected. 0: enable 1: disable	
detect_vcr_when_h_unlock	0	R/W	1	enable to detect VCR when h sync is unlocked. 0: disable 1: enable	

Register::CENABLE_LINE_COUNT 0xD2					
Name	Bits	Read/Write	Reset State	Comments	Config
cenable_line_count	7:0	R	0	cenable_line_count [7:0]	

Register::MEASURE_FIRST_V_HI 0xD3					
Name	Bits	Read/Write	Reset State	Comments	Config
reserved	7:2	--	--	Reserved.	
V_1st_line [9:8]	1:0	R	0	V_1st_line [9:8]	

Register::MEASURE_FIRST_V_LOW 0xD4					
Name	Bits	Read/Write	Reset State	Comments	Config
V_1st_line [7:0]	7:0	R	0	V_1st_line [7:0]	

Register::MEASURE_SECOND_V_HI 0xD5					
Name	Bits	Read/Write	Reset State	Comments	Config
reserved	7:2	--	--	Reserved.	
V_2nd_line [9:8]	1:0	R	0	V_2nd_line [9:8]	

Register::MEASURE_SECOND_V_LOW 0xD6					
Name	Bits	Read/Write	Reset State	Comments	Config

V_2nd_line [7:0]	7:0	R	0	V_2nd_line [7:0]	
------------------	-----	---	---	------------------	--

Register::PORCH_HEIGHT_M 0xD7					
Name	Bits	Read/Write	Reset State	Comments	Config
reserved	7:5	--	--	Reserved.	
Porch_h[12:8]	4:0	R	0	porch_height_measure: MSB[12:8].	

Register::PORCH_HEIGHT_L 0xD8					
Name	Bits	Read/Write	Reset State	Comments	Config
Porch_h[7:0]	7:0	R	0	porch_height_measure: LSB[7:0].	

Register::Signal_STM_Control 0xD9					
Name	Bits	Read/Write	Reset State	Comments	Config
reserved	7:4	--	--	reserved.	
field_toggle_en	3	R/W	1	force field toggle when abnormal Input happens. 0: disable (force field signal to 0) 1: enable (original zoran mode)	
reserved	2:0	--	--	reserved	

Register::CDETECT_PHASE_ERR_STATUS2 0xDA					
Name	Bits	Read/Write	Reset State	Comments	Config
reserved	7:6	--	0	reserved	
cdet_phase_err_status[13:8]	5:0	R	0	status bits [13:8] of the 14-bit-wide phase error status of cdetect	

Register::CDETECT_PHASE_ERR_STATUS1 0xDB					
Name	Bits	Read/Write	Reset State	Comments	Config
cdet_phase_err_status[7:0]	7:0	R	0	status bits [7:0] of the 14-bit-wide phase error status of cdetect	

Macrovision Control Registers

Register::MV_DETECT_WINDOW 0xDC					
Name	Bits	Read/Write	Reset State	Comments	Config
Mv_window2_value	7:0	R/W	0x19	MacroVision detect window setting	

Register::MV_BURSTGATE_START 0xDD					
Name	Bits	Read/Write	Reset State	Comments	Config
Ad_burst_gate_start	7:0	R/W	0x32	MacroVision burstgate detect window start time.	

art					
-----	--	--	--	--	--

Register::MV_BURSTGATE_END 0xDE					
Name	Bits	Read/Write	Reset State	Comments	Config
Ad_burst_gate_end	7:0	R/W	0x46	MacroVision burstgate detect window end time	

Register::COLORSTRIPE_CONTROL 0xDF					
Name	Bits	Read/Write	Reset State	Comments	Config
reserved	7:3	--	--	reserved	
Cstripe_detect_control	2:0	R/W	0	Colorstripe control.	

Debug Test

Register::DEBUG_MUX 0xE0					
Name	Bits	Read/Write	Reset State	Comments	Config
debug_test_enable	7	R/W	0	enable the debug mode. When set, disable the normal output and switch to internal signal. 0: disable 1: enable	
debug_test	6:0	R/W	0	internal signal select for debug. 0x00: internal debug mode 0x01: internal video 16 output 0x02: ADC input test mode 0x03: 4fsc data mode 0x04: phase error mode 0x05: mode detect debug mode(1) 0x06: mode detect debug mode(2) 0x07: mode detect debug mode(3) 0x08: mode detect debug mode(4) 0x09: mode detect debug mode(5) 0x0a: HPLL debug mode 0x0b: Interrupt debug mode 0x0c: ADC12 output mode 0x0d: ADC12 control mode 0x0e: PLL output mode 0x0f: PLL control mode 0x10: FIFO output mode others : reserved	

Register::VIDEO_DEBUG_ANALOG 0xE1					
Name	Bits	Read/Write	Reset State	Comments	Config
muxanalogB	7:4	R/W	0	control the data sent to the analog DAC test point B.	
muxanalogA	3:0	R/W	0	control the data sent to the analog DAC test point A.	

Register::VIDEO_DEBUG_DIGITAL 0xE2					
------------------------------------	--	--	--	--	--

Name	Bits	Read/Write	Reset State	Comments	Config
reserved	7:4	--	--	reserved	
muxdigital	3:0	R/W	0	control the data path sent to the digital test point.	

Register::BIST_TEST1 0xE3					
Name	Bits	Read/Write	Reset State	Comments	Config
bist_mode	7	R/W	0	Sram Bist mode start.	
bist_rst_n	6	R/W	1	Bist reset.	
reserved	5:0	--	--		

Register::BIST_TEST2 0xE4					
Name	Bits	Read/Write	Reset State	Comments	Config
reserved	7:6	--	--	Reserved	
bist_done	5	R	0		
bist_fail_0	4	R	0		
bist_fail_1	3	R	0		
bist_fail_2	2	R	0		
bist_fail_3	1	R	0		
bist_fail_4	0	R	0		

Address : 0xE5 Reserved

Register::PATTERN_CONTROL 0xE6					
Name	Bits	Read/Write	Reset State	Comments	Config
ad1_dma_en	7	R/W	0	AD1 input from DMA1. 1: From DMA1. 0: From ADC1.	
ad2_dma_en	6	R/W	0	AD2 input from DMA2. 1: From DMA2. 0: From ADC2.	
reserved	5:3	--	--	Reserved.	
crc_chk_sel	2	R/W	0	0: for QC 1: for MP	
pattern_gen_cvbs_mode	1	R/W	0	0: NTSC 1: PAL-I	
pattern_generator_enable	0	R/W	0	enable the pattern generator.	

Note: CRC generator polynomial:

$$X^{32} + X^{26} + X^{23} + X^{22} + X^{16} + X^{12} + X^{11} + X^{10} + X^8 + X^7 + X^5 + X^4 + X^2 + X + 1$$

Register::CRC_RESULT2 0xE7					
Name	Bits	Read/Write	Reset State	Comments	Config
reserved	7:4	--	--	Reserved.	
CRC_result_2	3:0	R	0	CRC check result: hi byte (19:16).	

Register::CRC_RESULT1					0xE8	
Name	Bits	Read/Write	Reset State	Comments	Config	
CRC_result_1	7:0	R	0	CRC check result: low byte (15:8).		

Register::CRC_RESULT0					0xE9	
Name	Bits	Read/Write	Reset State	Comments	Config	
CRC_result_0	7:0	R	0	CRC check result: low byte (7:0).		

Address : 0xEA ~ 0xEB Reserved

Register::FPGA_test_reg1					0xEC	
Name	Bits	Read/Write	Reset State	Comments	Config	
Fpga_test1	7:0	R/W	0	Reserved for FPGA test.		

Register::FPGA_test_reg2					0xED	
Name	Bits	Read/Write	Reset State	Comments	Config	
Fpga_test2	7:0	R/W	0	Reserved for FPGA test.		

Register::FPGA_test_reg3					0xEE	
Name	Bits	Read/Write	Reset State	Comments	Config	
Fpga_test3	7:0	R/W	0	Reserved for FPGA test.		

Register::FPGA_test_reg4					0xEF	
Name	Bits	Read/Write	Reset State	Comments	Config	
Fpga_test4	7:0	R/W	0	Reserved for FPGA test.		

ADC Clamping Test Mode

Register::clamp_test_reg0 0xF0					
Name	Bits	Read/Write	Reset State	Comments	Config
C_blevel[7:0]	7:0	R	0	The blank level of red or Pr signal. Bit 7 to bit 0.	

Register::clamp_test_reg1 0xF1					
Name	Bits	Read/Write	Reset State	Comments	Config
reserved	7:4	--	--	reserved	
C_blevel[11:8]	3:0	R	0	The blank level of red or Pr signal. Bit 11 to bit 8.	

Register::clamp_test_reg6 0xF2					
Name	Bits	Read/Write	Reset State	Comments	Config
Comp_blevel[7:0]	7:0	R	0	The blank level of composite or Y signal. Bit 7 to bit 0.	

Register::clamp_test_reg7 0xF3					
Name	Bits	Read/Write	Reset State	Comments	Config
reserved	7:4	--	--	reserved	
Comp_blevel[11:8]	3:0	R	0	The blank level of composite or Y signal. Bit 11 to bit 8.	

Register::clamp_test_reg8 0xF4					
Name	Bits	Read/Write	Reset State	Comments	Config
Comp_slevel[7:0]	7:0	R	0	The sync level of composite or Y signal. Bit 7 to bit 0.	

Register::clamp_test_reg9 0xF5					
Name	Bits	Read/Write	Reset State	Comments	Config
reserved	7:4	--	--	reserved	
Comp_slevel[11:8]	3:0	R	0	The sync level of composite or Y signal. Bit 11 to bit 8.	

Register::clamp_test_reg10 0xF6					
Name	Bits	Read/Write	Reset State	Comments	Config
ADC1_Voffset[7:0]	7:0	R/W	0	The Voltage offset setting for ADC1. Bit 7 to bit 0.	

Register::clamp_test_reg11 0xF7					
Name	Bits	Read/Write	Reset State	Comments	Config

		Write	State	
reserved	7:2	--	--	reserved
ADC1_Voffset[9:8]	1:0	R/W	0	The Voltage offset setting for ADC1. Bit 9 to bit 8.

Register::clamp_test_reg12		0xF8			
Name	Bits	Read/Write	Reset State	Comments	Config
ADC2_Voffset[7:0]	7:0	R/W	0	The Voltage offset setting for ADC2. Bit 7 to bit 0.	

Register::clamp_test_reg13		0xF9			
Name	Bits	Read/Write	Reset State	Comments	Config
reserved	7:2	--	--	reserved	
ADC2_Voffset[9:8]	1:0	R/W	0	The voltage offset setting for ADC2. Bit 9 to bit 8.	

Register::clamp_test_reg17		0xFA			
Name	Bits	Read/Write	Reset State	Comments	Config
reserved	7:1	--	--	reserved	
Clamp_sel	0	R/W	0	The clamping position selection. 0: backporch gate 1: sync tip gate	

Address : 0xFB ~ 0xFD Reserved

Chip Version

Register::CHIP_VER1		0xFE			
Name	Bits	Read/Write	Reset State	Comments	Config
Chip_ver1	7:0	R	0	Subversion MSB byte	

Register::CHIP_VER2		0xFF			
Name	Bits	Read/Write	Reset State	Comments	Config
Chip_ver2	7:0	R	0	Subversion LSB byte	

Off line sync processor(page B)

Address: A0 SYNC_SELECT Default: 00h

Bit	Mode	Function
7	R/W	Off-line Sync Processor Power Down (Stop Crystal Clock In) 0: Normal Run (Default) 1: Power Down
6	R/W	HSYNC Type Detection Auto Run

		0: manual (Default) 1: automatic
5	R/W	De-composite circuit enable 0: Disable (Default) 1: Enable
4	R/W	Input Sync. Source selection 0: HS_RAW(SS/CS) (Default) 1: SOG/SOY
3:2	R/W	Input Sync. Source is HS_RAW, CR.A0[4] = 0 2'bx0: AHS0/AVS0 (Default) 2'bx1: AHS1/AVS1 Input Sync. Source is SOG, CR.A0[4] = 1. 2'b00: VGA-SOG0 (Default) 2'b01: VGA-SOG1 2'b1x: Video-ADC SOG
1	R/W	Reserved to 0.
0	R/W	HSYNC & VSYNC Measured Mode 0: HS period counted by crystal clock & VS period counted by HS (Analog mode) (Default) 1: H resolution counted by input clock & V resolution counted by ENA (Digital mode) (Get the correct resolution which is triggered by enable signal, ENA)

Address: A1
SYNC_INVERT
Default: 00h

Bit	Mode	Function
7	R/W	COAST Signal Invert Enable: 0: Not inverted (Default) 1: Inverted
6	R/W	COAST Signal Output Enable: 0: Disable (Default) 1: Enable
5	R/W	HS_OUT Signal Invert Enable: 0: Not inverted (Default) 1: Inverted
4	R/W	HS_OUT Signal Output Enable: 0: Disable (Default) 1: Enable
3	R/W	CS_RAW Inverted Enable 0: Normal (Default)

		1: Invert
2	R/W	CLAMP Signal Output Enable 0: Disable (Default) 1: Enable
1	R/W	HS Masked in Coast 0: Disable (Default) (SS/SOY) 1: Enable (CS or SOG)
0	R/W	Reserved to 0

Address: A2
SYNC_CTRL (SYNC Control Register)
Default: 06h

Bit	Mode	Function
7	R/W	Reserved to 0
6	R/W	Select HS_OUT Source Signal 0: Bypass (SeHs)(Use in Separate Mode) 1: Select De-Composite HS out(DeHs) (In Composite mode)
5	R/W	Select ADC_VS Source Signal (Auto switch in Auto Run Mode) 0: VS_RAW 1: DeVS
4	R/W	CLK Inversion to latch ADC HS for Clamp 0: Non Inversion (Default) 1: Inversion
3	R/W	Inversion of HSYNC to measure VSYNC 0: Non Inversion (Default) 1: Inversion
2	R/W	HSYNC Measure Source(ADC_HS1) 0: Select ADC_HS 1: Select SeHS or DeHS by CR49[6] (Default)
1:0	R/W	Measure HSYNC/VSYNC Source Select: 00: Reserved 01: VIDEO8 / VIDEO16 10: ADC_HS1/ADC_VS (Default) 11: CS_RAW/VS_RAW

Address: A3
STABLE_HIGH_PERIOD_H
Default: 00h

Bit	Mode	Function
7	R	Even/Odd Field of YPbPr (By Line-Count Mode) 0: Even 1: Odd

6	R	The Toggling of Polarity of YPbPr Field Happened (By Line-Count Mode) 0: No toggle 1: Toggle
5	R	Even/Odd Field of YPbPr (By VS-Position Mode) 0: Even 1: Odd
4	R	The Toggling of Polarity of YPbPr Field Happened (By VS-Position Mode) 0: No toggle 1: Toggle
3	R/W	Odd Detection Mode 0: Line-Count Mode (Default) 1: VS-Position Mode
2:0	R	Stable High Period[10:8] Compare each line's high pulse period, if we get continuous 64 lines with the same one, the period is updated as the stable period.

Address: A4 **STABLE_HIGH_PERIOD_L**

Bit	Mode	Function
7:0	R	Stable High Period[7:0] Compare each line's high pulse period, if we get continuous 64 lines with the same one, the period is updated as the stable period.

Address: A5 **VSYNC_COUNTER_LEVEL_MSB** **Default: 03h**

Bit	Mode	Function
7	R	HSYNC Type Detection Auto Run Result ready
6:4	R	HSYNC Type Detection Auto Run Result 000: No Signal 001: Not Support 010: YPbPr 011: Serration Composite SYNC 100: XOR/OR-Type Composite SYNC with Equalizer 101: XOR/OR-Type Composite SYNC without Equalizer 110: HSYNC with VS_RAW (Separate HSYNC) 111: HSYNC without VS_RAW (HSYNC only) Reference when Hsync type detection auto run result ready (CR A5[7])
3	R/W	Reserved to 0
2:0	R/W	VSYNC counter level count [10:8] MSB VSYNC detection counter start value.

Address: A6 **VSYNC_COUNTER_LEVEL_LSB** **Default: 00h**

Bit	Mode	Function
7:0	R/W	VSYNC counter level count [7:0] LSB

Address: A7 HSYNC_TYPE_DETECTION_FLAG

Bit	Mode	Function
7	R	HSYNC Overflow (16-bits)
6	R	Stable Period Change (write clear when CRA7[6]=1 or CRA8[0]=1)
5	R	Stable Polarity Change (write clear when CR A7 [5]=1 or CR A8 [0]=1)
4	R	VS_RAW Edge Occurs (write clear when CR A7 [4]=1 or CR A8 [0]=1) If VS_RAW edge occurs, this bit is set to "1".
3	R	Detect Capture Window Unlock Repeated 32 Times (write clear when CR A7 [3]=1 or CR A8 [0]=1)
2	R	HSYNC with Equalization (write clear when CR A7 [2]=1 or CR A8 [0]=1)
1	R	HSYNC Polarity Change (write clear when CR A7 [1]=1 or CR A8 [0]=1)
0	R	Detect Capture Window Unlock (write clear when CR A7 [0]=1 or CR A8 [0]=1)

Address: A8 STABLE_MEASURE Default: 00h

Bit	Mode	Function
7	R	Stable Flag 0: Period or polarity can't get continuous stable status. 1: Both polarity and period are stable.
6	R	Stable Polarity 0: Negative 1: Positive Compare each line's polarity; if we get continuous N 64 lines with the same one, the polarity is updated as the stable polarity.
5:4	R/W	Feedback HSYNC High Period Select by ADC Clock: 00: 32 (Default) 01: 64 10: 96 11: 128
3	R/W	Stable Period Tolerance 0: ±2 crystal clks (Default) 1: ±4 crystal clks
2	R/W	VSYNC measure invert Enable 0: Disable (Default) 1: Enable

1	R/W	Pop Up Stable Value 0: No Pop Up (Default) 1: Pop Up Result, (CRA3[2:0], CRA4[7:0], CRA7[3], CRA9[2:0], CRAA[7:0])
0	R/W	Stable Measure Start 0 : Stop (Default) 1 : Start

Address: A9 **Stable_Period_H** **Default: 80h**

Bit	Mode	Function
7	R	Measure One Frame Status 0: Finished after 1 frame measuring / Measure finished 1: Measuring Now
6	R	CS_RAW Inverted by Auto Run Mode 0: Not inverted 1: Inverted
5	R/W	HS_OUT Bypass PLL into VGIP 0: Disable (Default) 1: Enable
4	R/W	Reserved to 0
3	R/W	ADC_VS Source Select in Test Mode 0: Select ADC_VS Source in Normal Mode or Auto Mode by CRA0[6] (Default) 1: Select ADC_VS Source in Test Mode (Select VS_RAW or DeVS by CRA2[5])
2:0	R	Stable Period[10:8] Compare each line's period, if we get continuous 64 lines with the same one, the period is updated as the stable period.

Address: AA **Stable_Period_L**

Bit	Mode	Function
7:0	R	Stable Period[7:0] Compare each line's period, if we get continuous 64 lines with the same one, the period is updated as the stable period.

Address: AB **MEAS_HS_PER_H (HSYNC Period Measured Result)** **Default: 8'b000xxxxx**

Bit	Mode	Function
7	R/W	On Line Auto Measure Enable 0: Disable (Default) 1: Enable
6	R/W	Pop Up Period Measurement Result 0: No Pop Up (Default) 1: Pop Up Result

5	R/W	Start a HS & VS period / H & V resolution & polarity measurement (on line monitor) 0: Finished/Disable (Default) 1: Enable to start a measurement, auto cleared after finished
4	R	Over-flow bit of Input HSYNC Period Measurement 0: No Over-flow occurred 1: Over-flow occurred
3:0	R	Input HSYNC Period Measurement Result: High Byte[11:8]

Address: AC MEAS_HS_PER_L (HSYNC Period Measured Result)

Bit	Mode	Function
7:0	R	Input HSYNC Period Measurement Result: Low Byte[7:0]

† The result is expressed as the average number of crystal clocks (CRA0[0]=0), ~~or input clocks (CR47[0]=1)~~ between 2 HSYNC.

l The result is the total number of crystal/input clocks inside 16-HSYNC periods divided by 16.

l Fractional part of measure result is stored in CRAF[3:0].

Address: AD MEAS_VS_PER_H (VSYNC Period Measured Result)

Bit	Mode	Function
7	R	Input VSYNC Polarity Indicator 0: negative polarity (high period is longer than low one) 1: positive polarity (low period is longer than high one)
6	R	Input HSYNC Polarity Indicator 0: negative polarity (high period is longer than low one) 1: positive polarity (low period is longer than high one)
5	R	Time-Out bit of Input VSYNC Period Measurement (No VSYNC occurred) 0: No Time Out 1: Time Out occurred
4	R	Over-flow bit of Input VSYNC Period Measurement 0: No Over-flow occurred 1: Over-flow occurred
3:0	R	Input VSYNC Period Measurement Result: High Byte[11:8]

Address: AE MEAS_VS_PER_L (VSYNC Period Measured Result)

Bit	Mode	Function
7:0	R	Input VSYNC Period Measurement Result: Low Byte[7:0]

l This result is expressed in terms of input HS pulses.

l When measured digitally, the result is expressed as the number of input ENA signal within a frame.

Address: AF MEAS_HS&VS_HI_H (HSYNC&VSYNC High Period Measured Result)

Bit	Mode	Function
-----	------	----------

7:4	R	Input HSYNC High Period Measurement Result: High Byte[11:8] (CRB1[0] = 0) Input VSYNC High Period Measurement Result: High Byte[11:8] (CRB1[0] = 1)
3:0	R	Input HSYNC Period Measurement Fractional Result (See CRAB,AC)

Address: B0 MEAS_HS&VS_HI_L (HSYNC&VSYNC High Period Measured Result)

Bit	Mode	Function
7:0	R	Input HSYNC High Period Measurement Result: Low Byte[7:0] (CRB1[0] = 0) Input VSYNC High Period Measurement Result: Low Byte[7:0] (CRB1[0] = 1)

I This result of HSYNC high-period is expressed in terms of crystal clocks. When measured digitally, the result of HSYNC high-period is expressed as the number of input clocks inside the input enable signal.

I This result of VSYNC high-period is expressed in terms of input HS pulses

Address: B1 MEAS_HS&VS_HI_SEL (VSYNC High Period Measured Result) Default:00h

Bit	Mode	Function
7:6	R/W	HSYNC_MAX_DELTA 00: Don't care (CR B1 [3] will never go high) 01: 4-clock 10: 8-clock 11: 16-clock
5:4	R/W	VSYNC_MAX_DELTA 00: Don't care (CR B1 [2] will never go high) 01: 2-HSYNC 10: 4-HSYNC 11: 8-HSYNC
3	R	HSYNC_OVER_RANGE Set to 1 if variation of HSYNC larger than HSYNC_MAX_DELTA is detected by on-line measurement (CR B1 [7]=1). Write to clear this flag.
2	R	VSYNC_OVER_RANGE Set to 1 if variation of VSYNC larger than VSYNC_MAX_DELTA is detected by on-line measurement (CR52[7]=1). Write to clear this flag.
1	R/W	Start Measurement after Mode Detection Auto-mode 0: Disable 1: Enable (Default)
0	R/W	HSYNC/VSYNC High Period Measurement Result Select 0: HSYNC 1: VSYNC (See CRAF~CR B0)

Address: B2 Reserved to 0

Address: B3 SYNC_TEST_MISC

Default: 00h

Bit	Mode	Function
7	R/W	Clamp Reference Source Selection 0: Clamp source from normal HS 1: Clamp source from CS_RAW
6	R/W	Sync Processor Time-Clock Test Mode 0: Normal (Default) 1: Enable Test Mode; (switch 70ns-ck to the time-out & polarity counters)
5:3	R/W	Sync Processor Test Signals Output Selection (only active when on-line test-mode disable) 000: Disable Test-Output (Default) 001~111: Hidden
2:0	R	The Number of Input HS between 2 Input VSYNC. LSB bit [2:0] for YPbPr

Address: B4 **G_CLAMP_START (Clamp Signal Output Start)** **Default: 04h**

Bit	Mode	Function
7:0	R/W	Start of Output Clamp Signal Pulse for Y/G Channel[7:0]: Determine the number of input double-pixel between the trailing edge of input HSYNC and the start of the output CLAMP signal.

Address: B5 **G_CLAMP_END (Clamp Signal Output End)** **Default: 10h**

Bit	Mode	Function
7:0	R/W	End of Output Clamp Signal Pulse for Y/G Channel [7:0]: Determine the number of input double-pixel between the trailing edge of input HSYNC and the end of the output CLAMP signal.

Address: B6 **BR_CLAMP_START (Clamp Signal Output Start)** **Default: 04h**

Bit	Mode	Function
7:0	R/W	Start of Output Clamp Signal Pulse for B/Pb and R/Pr Channel [7:0]: Determine the number of input double-pixel between the trailing edge of input HSYNC and the start of the output CLAMP signal.

Address: B7 **BR_CLAMP_END (Clamp Signal Output End)** **Default: 10h**

Bit	Mode	Function
7:0	R/W	End of Output Clamp Signal Pulse for B/Pb and R/Pr Channel [7:0]: Determine the number of input double-pixel between the trailing edge of input HSYNC and the end of the output CLAMP signal.

Address: B8 **CLAMP_CTRL0** **Default:00h**

Bit	Mode	Function
7	R/W	Clamp Trigger Edge Inverse for Y/G Channel 0: Trailing edge (Default) 1: Leading edge
6	R/W	Clamp Trigger Edge Inverse for B/Pb and R/Pr Channel

		0: Trailing edge (Default) 1: Leading edge
5:0	R/W	Mask Line Number before DeVS [5:0]

Address: B9 **CLAMP_CTRL1** **Default: 00h**

Bit	Mode	Function
7	R/W	Clamp Mask Enable 0: Disable (Default) 1: Enable
6	R/W	Select Clamp Mask as De VS 0: Disable 1: Enable
5:0	R/W	Mask Line Number after DeVS [5:0]

CRB8[5:0] and CRB9[5:0] will set number of Mask Line before/after DeVS for Clamp Mask.

Address: BA **CLAMP_CTRL2** **Default: 00h**

Bit	Mode	Function
7	R/W	Clamp Clock Source 0: ADC_Clock (Default) 1: Crystal Clock
6	R/W	Clamp Counter Unit (CRB4~CRB7) 0: Double Pixels (Default) 1: Single Pixel
5	R/W	Off-line ADC Clamp Enable 0: Disable (Default) 1: Enable
4	R/W	Off-line ADC Selection 0: ADC-0 (Default) 1: ADC-1
3	R/W	Off-Line ADC-3 Clamp Source 0: Clamp-G (Default) 1: Clamp-BR
3	R/W	Off-Line ADC-2 Clamp Source 0: Clamp-G (Default) 1: Clamp-BR
3	R/W	Off-Line ADC-1 Clamp Source 0: Clamp-G (Default) 1: Clamp-BR

3	R/W	Off-Line ADC-0 Clamp Source 0: Clamp-G (Default) 1: Clamp-BR
---	-----	---

Address: BB **CLAMP_CTRL3** **Default: 00h**

Bit	Mode	Function
7	R/W	Video-ADC-3 Clamp Output Enable 0: Disable (Default) 1: Enable
6	R/W	Video-ADC-2 Clamp Output Enable 0: Disable (Default) 1: Enable
5	R/W	Video-ADC-1 Clamp Output Enable 0: Disable (Default) 1: Enable
4	R/W	Video-ADC-0 Clamp Output Enable 0: Disable (Default) 1: Enable
3	R/W	Video-ADC-3 Clamp Source 0: Clamp-G (Default) 1: Clamp-BR
2	R/W	Video-ADC-2 Clamp Source 0: Clamp-G (Default) 1: Clamp-BR
1	R/W	Video-ADC-1 Clamp Source 0: Clamp-G (Default) 1: Clamp-BR
0	R/W	Video-ADC-0 Clamp Source 0: Clamp-G (Default) 1: Clamp-BR

Address: BC **COAST_CTRL** **Default: 21h**

Bit	Mode	Function
7:4	R/W	Start of COAST before DeVS Leading Edge [3:0]
3:0	R/W	End of COAST after DeVS Trailing Edge [3:0]

Address: BD **CAPTURE_WINDOW_SETTING** **Default: 04h**

Bit	Mode	Function
-----	------	----------

7	R/W	Reserved to 0
6	R/W	Capture Miss Limit during Hsync Extraction 0: 32 (Default) 1: 16
5	R/W	Capture Window add step as Miss Lock 0: ± 1 crystal clks (Default) 1: ± 2 crystal clks
4:0	R/W	Capture Window Tolerance 5'h00: ± 6 crystal clks for capture window 5'h01 ~ 5'h1F: $\pm 1 \sim \pm 31$ crystal clks for capture window

Address: BE **DETECTION_TOLERANCE_SETTING** **Default: 00h**

Bit	Mode	Function
7	R/W	Reserved to 0
6:5	R/W	Stable Period Tolerance Extension 00: Use CRA8 [3] Setting (Default) 01: ± 4 crystal clks 10: ± 8 crystal clks 11: ± 16 crystal clks
4:0	R/W	H-sync for De-composite De-bounce Length 5'h00: Disable De-bounce Function (Default) 5'h01 ~ 5'h1F: De-bounce 1 ~ 31 crystal clks for de-composite

Address: BF **Skip-Line Control** **Default: 00h**

Bit	Mode	Function
7:4	R/W	Skip Line[3:0] Skip Lines after Vsync detected
3:0	R/W	Reserved to 0

Auto SOY(page B)

SOY Channel 0

// channel0.SOY auto compare level detect control Register0

Register::SOYCH0_CFG0					0xc0
Name	Bits	Read/Write	Reset State	Comments	Config
CH0_Delta	7:2	R/W	0x10	Delta value from detected lowest level for hsync detecting	
CH0_Digital_LPF	1:0	R/W	0x1	Digital LPF after ADC 00: 1 tap 01: 2 taps 10: 4 taps	

				11: 4 taps	
--	--	--	--	------------	--

Register::SOYCH0_CFG1					0xc1
Name	Bits	Read/Write	Reset State	Comments	Config
CH0_DEBOUNCE_SE L	7:5	R/W	0x4	Debounce Select 000 : No-debounce 001 : 2T debounce 010 : 3T debounce 111 : 8T debounce	
CH0_IE_E	4	R/W	0x0	Auto 1/2 sync level detect time out interrupt enable 0: disable 1: enable	
CH0_MLPF_MS	3:2	R/W	0x1	Moving average LPF mode select 00: 8 taps 01: 16 taps 10: 32 taps others : 16 taps	
CH0_ADC_LPF	1:0	R/W	0x2	Digital LPF BW select 00:2 points average filter 01:4 points average filter 10:8 points average filter 11:16 points average filter default : 4 point average filter	

// channel0 SOY auto compare level detect control Register1

Register::SOYCH0_CFG2					0xc2
Name	Bits	Read/Write	Reset State	Comments	Config
CH0_MODE	7	R/W	0x1	Auto 1/2 sync level detect mode 0: one shot 1: continue	
CH0_OFFSET_V	6:0	R/W	0x0	offset value SOY compare level=offset value+feedback value Bit 6 is sign bit	

Register::SOYCH0_CFG3					0xc3
Name	Bits	Read/Write	Reset State	Comments	Config
CH0_ENABLE	7	R/W	0x0	Auto 1/2 sync level detect enable/ disable 0: disable 1: enable	
Reserved	6	-			
CH0_M_CMPL	5:0	R/W	0x1E	Compare level Manual setting Only valid when CH0_CMPL_U_Sel set 0	

Register::SOYCH0_CFG4					0xc4
Name	Bits	Read/Write	Reset State	Comments	Config
CH0_D_TIME	7:4	R/W	0x4	Compare level auto update delay time after 1/2 sync level latched for continue mode. The Dealy Time Output Hsync DC Level for Analog Issue.	
CH0_CMPL_U_Sel	3	R/W	0	Compare level update source sel 0: Manual compare level 1: Auto compare level	
CH0_U_mode	2	R/W	0x0	Compare level update mode 0: normal 1: step updating	
CH0_U_step	1:0	R/W	0x0	compare level updating step 00:1/2 of sync DC_level(i)-DC_level(i-1) 01:1/4 of sync DC_level(i)-DC_level(i-1) 10:1/8 of sync DC_level(i)-DC_level(i-1) 11:1/16 of sync DC_level(i)-DC_level(i-1)	

Register::SOYCH0_CFG5					0xc5
Name	Bits	Read/Write	Reset State	Comments	Config
Reserved	7:6	-			
CH0_Min_diff	5:0	R/W	0x4	Minimum difference threshold to update compare level	

// channel0 SOY auto compare level detect control Register2

Register::SOYCH0_CFG6					0xc6
-----------------------	--	--	--	--	------

Name	Bits	Read/Write	Reset State	Comments	Config
CH0_TO_count_15_8	7:0	R/W	0x10	TO_count[15:8], Time Out counter for lowest level to detect time out	

Register::SOYCH0_CFG7 0xc7					
Name	Bits	Read/Write	Reset State	Comments	Config
CH0_TO_count_7_0	7:0	R/W	0x00	TO_count[7:0], Time Out counter for lowest level to detect time out	

Register::SOYCH0_CFG8 0xc8					
Name	Bits	Read/Write	Reset State	Comments	Config
CH0_L_count_15_8	7:0	R/W	0x08	L_count[15:8], Lowest level detect sample count	

Register::SOYCH0_CFG9 0xc9					
Name	Bits	Read/Write	Reset State	Comments	Config
CH0_L_count_7_0	7:0	R/W	0x00	L_count[7:0], Lowest level detect sample count	

// channel0 SOY auto compare level detect status Register0

Register::SOYCH0_CFGA 0xca					
Name	Bits	Read/Write	Reset State	Comments	Config
Reserved	7:6	-			
CH0_A_CMPL	5:0	R	0x0	Current Compare level setting by auto detection mechanism	

Register::SOYCH0_CFGB 0xcb					
Name	Bits	Read/Write	Reset State	Comments	Config
Reserved	7:6	-			
CH0_OUT_DC	5:0	R	0x0	Value of detected DC level	

Register::SOYCH0_CFGC 0xcc					
Name	Bits	Read/Write	Reset State	Comments	Config
CH0_LOW_LEVEL	7:2	R	0x0	Detected Lowest level	
CH0_OS_F	1	R	0x0	One shot mode Auto 1/2 sync level detection	Wclr_out

				status flag 0 : running 1 : complete	
CH0_TO_F	0	R	0x0	Auto 1/2 sync level detect time out flag 0: normal 1: time out	Wclr_out

SOY Channel 1

// channel1 SOY auto compare level detect control Register0

Register::SOYCH1_CFG0				0xd0	
Name	Bits	Read/Write	Reset State	Comments	Config
CH1_Delta	7:2	R/W	0x10	Delta value from detected lowest level for hsync detecting	
CH1_Digital_LPF	1:0	R/W	0x1	Digital LPF after ADC 00: 1 tap 01: 2 taps 10: 4 taps 11: 4 taps	

Register::SOYCH1_CFG1				0xd1	
Name	Bits	Read/Write	Reset State	Comments	Config
CH1_DEBOUNCE_SE L	7:5	R/W	0x4	Debounce Select 000 : No-debounce 001 : 2T debounce 010 : 3T debounce 111 : 8T debounce	
CH1_IE_E	4	R/W	0x0	Auto 1/2 sync level detect time out interrupt enable 0: disable 1: enable	
CH1_MLPF_MS	3:2	R/W	0x1	Moving average LPF mode select 00: 8 taps 01: 16 taps 10: 32 taps others : 16 taps	
CH1_ADC_LPF	1:0	R/W	0x2	Digital LPF BW select	

				00:2 points average filter 01:4 points average filter 10:8 points average filter 11:16 points average filter default : 4 point average filter	
--	--	--	--	---	--

// channel1 SOY auto compare level detect control Register1

Register::SOYCH1_CFG2				0xd2	
Name	Bits	Read/Write	Reset State	Comments	Config
CH1_MODE	7	R/W	0x1	Auto 1/2 sync level detect mode 0: one shot 1: continue	
CH1_OFFSET_V	6:0	R/W	0x0	offset value SOY compare level=offset value+feedback value Bit 6 is sign bit	

Register::SOYCH1_CFG3				0xd3	
Name	Bits	Read/Write	Reset State	Comments	Config
CH1_ENABLE	7	R/W	0x0	Auto 1/2 sync level detect enable/ disable 0: disable 1: enable	
Reserved	6	-			
CH1_M_CMPL	5:0	R/W	0x1E	Compare level Manual setting Only valid when CH1_CMPL_U_Sel set 0	

Register::SOYCH1_CFG4				0xd4	
Name	Bits	Read/Write	Reset State	Comments	Config
CH1_D_TIME	7:4	R/W	0x4	Compare level auto update delay time after 1/2 sync level latched for continue mode. The Dealy Time Output Hsync DC Level for Analog Issue.	
CH1_CMPL_U_Sel	3	R/W	0	Compare level update source sel 0: Manual compare level 1: Auto compare level	
CH1_U_mode	2	R/W	0x0	Compare level update mode 0: normal	

				1: step updating	
CH1_U_step	1:0	R/W	0x0	compare level updating step 00:1/2 of sync DC_level(i)-DC_level(i-1) 01:1/4 of sync DC_level(i)-DC_level(i-1) 10:1/8 of sync DC_level(i)-DC_level(i-1) 11:1/16 of sync DC_level(i)-DC_level(i-1)	

Register::SOYCH1_CFG5				0xd5	
Name	Bits	Read/Write	Reset State	Comments	Config
Reserved	7:6	-			
CH1_Min_diff	5:0	R/W	0x4	Minimum difference threshold to update compare level	

// channel1 SOY auto compare level detect control Register2

Register::SOYCH1_CFG6				0xd6	
Name	Bits	Read/Write	Reset State	Comments	Config
CH1_TO_count_15_8	7:0	R/W	0x10	TO_count[15:8], Time Out counter for lowest level to detect time out	

Register::SOYCH1_CFG7				0xd7	
Name	Bits	Read/Write	Reset State	Comments	Config
CH1_TO_count_7_0	7:0	R/W	0x00	TO_count[7:0], Time Out counter for lowest level to detect time out	

Register::SOYCH1_CFG8				0xd8	
Name	Bits	Read/Write	Reset State	Comments	Config
CH1_L_count_15_8	7:0	R/W	0x08	L_count[15:8], Lowest level detect sample count	

Register::SOYCH1_CFG9				0xd9	
Name	Bits	Read/Write	Reset State	Comments	Config
CH1_L_count_7_0	7:0	R/W	0x00	L_count[7:0], Lowest level detect sample count	

// channel1 SOY auto compare level detect status Register0

Register::SOYCH1_CFGA				0xda	
-----------------------	--	--	--	------	--

Name	Bits	Read/Write	Reset State	Comments	Config
Reserved	7:6	-			
CH1_A_CMPL	5:0	R	0x0	Current Compare level setting by auto detection mechanism	

Register::SOYCH1_CFGB 0xdb					
Name	Bits	Read/Write	Reset State	Comments	Config
Reserved	7:6	-			
CH1_OUT_DC	5:0	R	0x0	Value of detected DC level	

Register::SOYCH1_CFGC 0xdc					
Name	Bits	Read/Write	Reset State	Comments	Config
CH1_LOW_LEVEL	7:2	R	0x0	Detected Lowest level	
CH1_OS_F	1	R	0x0	One shot mode Auto 1/2 sync level detection status flag 0 : running 1 : complete	Wclr_out
CH1_TO_F	0	R	0x0	Auto 1/2 sync level detect time out flag 0: normal 1: time out	Wclr_out

Address:0xdf Reserved

SOY Channel 0 Calibration Ctrl

Register:: SOYCH0 Cali CFG0 0xe0					
Name	Bits	Read/Write	Reset State	Comments	Config
fporch_val_sel	7:4	R	5	Select the output value of ADC data, before the rising edge of hsync. The base of fporch_val_sel is 4 clock cycle	
Reserved	3	-			
calibrate_cnt_base	2:0	R/W	4	Delay clock number to latch the output value of ADC for ADC output stable issue.	

Register:: SOYCH0 Cali CFG1 0xe1					
Name	Bits	Read/Write	Reset State	Comments	Config

Reserved	7:3	-			
calibrate_val_rst	2	R/W	0	Reset the value of look-up table of auto calibrate mode to initial vale. Initial value table list below. 1'b1 : Reset 1'b0 : Non-reset DC_in Cali_out 6'h0 6'h0 6'h1 6'h1 ---- 6'h3e 6'h3e 6'h3f 6'h3f	
auto_calibrate_int_en	1	R/W	0	Enable the interrupt of Auto calibrate done. 1'b1 : Enable 1'b0 : Disable	
auto_calibrate_en	0	R/W	0	Enable ADC/DAC Auto Calibrate mode. When auto-calibrate mode enable, SOY will generate 0-63 to DAC. SOY will latch the output value of ADC to generate look-up table. This look-up table will be used to fix the offset & gain error of ADC/DAC. 1'b0 : Disable 1'b1 : Enable	

Register:: SOYCH0_Cali_CFG2					0xe2
Name	Bits	Read/Write	Reset State	Comments	Config
fporch_val	7:2	R/W	0	The front porch value of SOY	
Reserved	3	-			
cali_done	0	R	0	Auto calibrate done indicator 1'b1 : Done 1'b0 : Progress	wclr_out

SOY Channel 0 Calibration Value

Register:: Cali_Value_PORT_ADDR					0xe4
Name	Bits	Read/Write	Reset State	Comments	Config
Reserved	7:6	-			

Cali_port_addr	5:0	R/W	0	Cali Value Access Port Address	
----------------	-----	-----	---	--------------------------------	--

Register:: Cali_Value_PORT_DATA					0xe5
Name	Bits	Read/Write	Reset State	Comments	Config
Cali_port_data	7:0	R/W	0x00	Cali Value Access Port Data	

Register::Cali_Value_0					(ACCESS[E4,E5]) 0x00
Name	Bits	Read/Write	Reset State	Comments	Config
Reserved	7:6	-			
cali_0	5:0	R	0	Auto Calibrate value of input 0 of ADC	

Register:: Cali_Value_1					(ACCESS[E4,E5]) 0x01
Name	Bits	Read/Write	Reset State	Comments	Config
Reserved	7:6	-			
cali_1	5:0	R	0	Auto Calibrate value of input 1 of ADC	

Register:: Cali_Value_2					(ACCESS[E4,E5]) 0x02
Name	Bits	Read/Write	Reset State	Comments	Config
Reserved	7:6	-			
cali_2	5:0	R	0	Auto Calibrate value of input 2 of ADC	

Register:: Cali_Value_3					(ACCESS[E4,E5]) 0x03
Name	Bits	Read/Write	Reset State	Comments	Config
Reserved	7:6	-			
cali_3	5:0	R	0	Auto Calibrate value of input 3 of ADC	

Register:: Cali_Value_4					(ACCESS[E4,E5]) 0x04
Name	Bits	Read/Write	Reset State	Comments	Config
Reserved	7:6	-			
cali_4	5:0	R	0	Auto Calibrate value of input 4 of ADC	

Register:: Cali_Value_5					(ACCESS[E4,E5]) 0x05
Name	Bits	Read/Write	Reset State	Comments	Config
Reserved	7:6	-			
cali_5	5:0	R	0	Auto Calibrate value of input 5 of ADC	

Register:: Cali_Value_6 (ACCESS[E4,E5] 0x06)					
Name	Bits	Read/Write	Reset State	Comments	Config
Reserved	7:6	-			
cali_6	5:0	R	0	Auto Calibrate value of input 6 of ADC	

Register:: Cali_Value_7 (ACCESS[E4,E5] 0x07)					
Name	Bits	Read/Write	Reset State	Comments	Config
Reserved	7:6	-			
cali_7	5:0	R	0	Auto Calibrate value of input 7 of ADC	

Register:: Cali_Value_8 (ACCESS[E4,E5] 0x08)					
Name	Bits	Read/Write	Reset State	Comments	Config
Reserved	7:6	-			
cali_8	5:0	R	0	Auto Calibrate value of input 8 of ADC	

Register:: Cali_Value_9 (ACCESS[E4,E5] 0x09)					
Name	Bits	Read/Write	Reset State	Comments	Config
Reserved	7:6	-			
cali_9	5:0	R	0	Auto Calibrate value of input 9 of ADC	

Register:: Cali_Value_a (ACCESS[E4,E5] 0x0a)					
Name	Bits	Read/Write	Reset State	Comments	Config
Reserved	7:6	-			
cali_a	5:0	R	0	Auto Calibrate value of input a of ADC	

Register:: Cali_Value_b (ACCESS[E4,E5] 0x0b)					
Name	Bits	Read/Write	Reset State	Comments	Config
Reserved	7:6	-			
cali_b	5:0	R	0	Auto Calibrate value of input b of ADC	

Register:: Cali_Value_c (ACCESS[E4,E5] 0x0c)					
Name	Bits	Read/Write	Reset State	Comments	Config
Reserved	7:6	-			
cali_c	5:0	R	0	Auto Calibrate value of input c of ADC	

Register:: Cali_Value_d (ACCESS[E4,E5] 0x0d)					
Name	Bits	Read/Write	Reset State	Comments	Config
Reserved	7:6	-			
cali_d	5:0	R	0	Auto Calibrate value of input d of ADC	

Register:: Cali_Value_e (ACCESS[E4,E5] 0x0e)					
Name	Bits	Read/Write	Reset State	Comments	Config
Reserved	7:6	-			
cali_e	5:0	R	0	Auto Calibrate value of input e of ADC	

Register:: Cali_Value_f (ACCESS[E4,E5] 0x0f)					
Name	Bits	Read/Write	Reset State	Comments	Config
Reserved	7:6	-			
cali_f	5:0	R	0	Auto Calibrate value of input f of ADC	

Register:: Cali_Value_10 (ACCESS[E4,E5] 0x10)					
Name	Bits	Read/Write	Reset State	Comments	Config
Reserved	7:6	-			
cali_10	5:0	R	0	Auto Calibrate value of input 10 of ADC	

Register:: Cali_Value_11 (ACCESS[E4,E5] 0x11)					
Name	Bits	Read/Write	Reset State	Comments	Config
Reserved	7:6	-			
cali_11	5:0	R	0	Auto Calibrate value of input 11 of ADC	

Register:: Cali_Value_12 (ACCESS[E4,E5] 0x12)					
Name	Bits	Read/Write	Reset State	Comments	Config
Reserved	7:6	-			
cali_12	5:0	R	0	Auto Calibrate value of input 12 of ADC	

Register:: Cali_Value_13 (ACCESS[E4,E5] 0x13)					
Name	Bits	Read/Write	Reset State	Comments	Config
Reserved	7:6	-			
cali_13	5:0	R	0	Auto Calibrate value of input 13 of ADC	

Register:: Cali_Value_14 (ACCESS[E4,E5] 0x14)					
Name	Bits	Read/Write	Reset State	Comments	Config
Reserved	7:6	-			
cali_14	5:0	R	0	Auto Calibrate value of input 14 of ADC	

Register:: Cali_Value_15 (ACCESS[E4,E5] 0x15)					
Name	Bits	Read/Write	Reset State	Comments	Config
Reserved	7:6	-			
cali_15	5:0	R	0	Auto Calibrate value of input 15 of ADC	

Register:: Cali_Value_16 (ACCESS[E4,E5] 0x16)					
Name	Bits	Read/Write	Reset State	Comments	Config
Reserved	7:6	-			
cali_16	5:0	R	0	Auto Calibrate value of input 16 of ADC	

Register:: Cali_Value_17 (ACCESS[E4,E5] 0x17)					
Name	Bits	Read/Write	Reset State	Comments	Config
Reserved	7:6	-			
cali_17	5:0	R	0	Auto Calibrate value of input 17 of ADC	

Register:: Cali_Value_18 (ACCESS[E4,E5] 0x18)					
Name	Bits	Read/Write	Reset State	Comments	Config
Reserved	7:6	-			
cali_18	5:0	R	0	Auto Calibrate value of input 18 of ADC	

Register:: Cali_Value_19 (ACCESS[E4,E5] 0x19)					
Name	Bits	Read/Write	Reset State	Comments	Config
Reserved	7:6	-			
cali_19	5:0	R	0	Auto Calibrate value of input 19 of ADC	

Register:: Cali_Value_1a (ACCESS[E4,E5] 0x1a)					
Name	Bits	Read/Write	Reset State	Comments	Config
Reserved	7:6	-			
cali_1a	5:0	R	0	Auto Calibrate value of input 1a of ADC	

Register:: Cali_Value_1b (ACCESS[E4,E5] 0x1b)					
Name	Bits	Read/Write	Reset State	Comments	Config
Reserved	7:6	-			
cali_1b	5:0	R	0	Auto Calibrate value of input 1b of ADC	

Register:: Cali_Value_1c (ACCESS[E4,E5] 0x1c)					
Name	Bits	Read/Write	Reset State	Comments	Config
Reserved	7:6	-			
cali_1c	5:0	R	0	Auto Calibrate value of input 1c of ADC	

Register:: Cali_Value_1d (ACCESS[E4,E5] 0x1d)					
Name	Bits	Read/Write	Reset State	Comments	Config
Reserved	7:6	-			
cali_1d	5:0	R	0	Auto Calibrate value of input 1d of ADC	

Register:: Cali_Value_1e (ACCESS[E4,E5] 0x1e)					
Name	Bits	Read/Write	Reset State	Comments	Config
Reserved	7:6	-			
cali_1e	5:0	R	0	Auto Calibrate value of input 1e of ADC	

Register:: Cali_Value_1f (ACCESS[E4,E5] 0x1f)					
Name	Bits	Read/Write	Reset State	Comments	Config
Reserved	7:6	-			
cali_1f	5:0	R	0	Auto Calibrate value of input 1f of ADC	

Register:: Cali_Value_20 (ACCESS[E4,E5] 0x20)					
Name	Bits	Read/Write	Reset State	Comments	Config
Reserved	7:6	-			
cali_20	5:0	R	0	Auto Calibrate value of input 20 of ADC	

Register:: Cali_Value_21 (ACCESS[E4,E5] 0x21)					
Name	Bits	Read/Write	Reset State	Comments	Config
Reserved	7:6	-			
cali_21	5:0	R	0	Auto Calibrate value of input 21 of ADC	

Register:: Cali_Value_22 (ACCESS[E4,E5] 0x22)					
Name	Bits	Read/Write	Reset State	Comments	Config
Reserved	7:6	-			
cali_22	5:0	R	0	Auto Calibrate value of input 22 of ADC	

Register:: Cali_Value_23 (ACCESS[E4,E5] 0x23)					
Name	Bits	Read/Write	Reset State	Comments	Config
Reserved	7:6	-			
cali_23	5:0	R	0	Auto Calibrate value of input 23 of ADC	

Register:: Cali_Value_24 (ACCESS[E4,E5] 0x24)					
Name	Bits	Read/Write	Reset State	Comments	Config
Reserved	7:6	-			
cali_24	5:0	R	0	Auto Calibrate value of input 24 of ADC	

Register:: Cali_Value_25 (ACCESS[E4,E5] 0x25)					
Name	Bits	Read/Write	Reset State	Comments	Config
Reserved	7:6	-			
cali_25	5:0	R	0	Auto Calibrate value of input 25 of ADC	

Register:: Cali_Value_26 (ACCESS[E4,E5] 0x26)					
Name	Bits	Read/Write	Reset State	Comments	Config
Reserved	7:6	-			
cali_26	5:0	R	0	Auto Calibrate value of input 26 of ADC	

Register:: Cali_Value_27 (ACCESS[E4,E5] 0x27)					
Name	Bits	Read/Write	Reset State	Comments	Config
Reserved	7:6	-			
cali_27	5:0	R	0	Auto Calibrate value of input 27 of ADC	

Register:: Cali_Value_28 (ACCESS[E4,E5] 0x28)					
Name	Bits	Read/Write	Reset State	Comments	Config
Reserved	7:6	-			
cali_28	5:0	R	0	Auto Calibrate value of input 28 of ADC	

Register:: Cali_Value_29 (ACCESS[E4,E5] 0x29)					
Name	Bits	Read/Write	Reset State	Comments	Config
Reserved	7:6	-			
cali_29	5:0	R	0	Auto Calibrate value of input 29 of ADC	

Register:: Cali_Value_2a (ACCESS[E4,E5] 0x2a)					
Name	Bits	Read/Write	Reset State	Comments	Config
Reserved	7:6	-			
cali_2a	5:0	R	0	Auto Calibrate value of input 2a of ADC	

Register:: Cali_Value_2b (ACCESS[E4,E5] 0x2b)					
Name	Bits	Read/Write	Reset State	Comments	Config
Reserved	7:6	-			
cali_2b	5:0	R	0	Auto Calibrate value of input 2b of ADC	

Register:: Cali_Value_2c (ACCESS[E4,E5] 0x2c)					
Name	Bits	Read/Write	Reset State	Comments	Config
Reserved	7:6	-			
cali_2c	5:0	R	0	Auto Calibrate value of input 2c of ADC	

Register:: Cali_Value_2d (ACCESS[E4,E5] 0x2d)					
Name	Bits	Read/Write	Reset State	Comments	Config
Reserved	7:6	-			
cali_2d	5:0	R	0	Auto Calibrate value of input 2d of ADC	

Register:: Cali_Value_2e (ACCESS[E4,E5] 0x2e)					
Name	Bits	Read/Write	Reset State	Comments	Config
Reserved	7:6	-			
cali_2e	5:0	R	0	Auto Calibrate value of input 2e of ADC	

Register:: Cali_Value_2f (ACCESS[E4,E5] 0x2f)					
Name	Bits	Read/Write	Reset State	Comments	Config
Reserved	7:6	-			
cali_2f	5:0	R	0	Auto Calibrate value of input 2f of ADC	

Register:: Cali_Value_30 (ACCESS[E4,E5] 0x30)					
Name	Bits	Read/Write	Reset State	Comments	Config
Reserved	7:6	-			
cali_30	5:0	R	0	Auto Calibrate value of input 30 of ADC	

Register:: Cali_Value_31 (ACCESS[E4,E5] 0x31)					
Name	Bits	Read/Write	Reset State	Comments	Config
Reserved	7:6	-			
cali_31	5:0	R	0	Auto Calibrate value of input 31 of ADC	

Register:: Cali_Value_32 (ACCESS[E4,E5] 0x32)					
Name	Bits	Read/Write	Reset State	Comments	Config
Reserved	7:6	-			
cali_32	5:0	R	0	Auto Calibrate value of input 32 of ADC	

Register:: Cali_Value_33 (ACCESS[E4,E5] 0x33)					
Name	Bits	Read/Write	Reset State	Comments	Config
Reserved	7:6	-			
cali_33	5:0	R	0	Auto Calibrate value of input 33 of ADC	

Register:: Cali_Value_34 (ACCESS[E4,E5] 0x34)					
Name	Bits	Read/Write	Reset State	Comments	Config
Reserved	7:6	-			
cali_34	5:0	R	0	Auto Calibrate value of input 34 of ADC	

Register:: Cali_Value_35 (ACCESS[E4,E5] 0x35)					
Name	Bits	Read/Write	Reset State	Comments	Config
Reserved	7:6	-			
cali_35	5:0	R	0	Auto Calibrate value of input 35 of ADC	

Register:: Cali_Value_36 (ACCESS[E4,E5] 0x36)					
Name	Bits	Read/Write	Reset State	Comments	Config
Reserved	7:6	-			
cali_36	5:0	R	0	Auto Calibrate value of input 36 of ADC	

Register:: Cali_Value_37 (ACCESS[E4,E5] 0x37)					
Name	Bits	Read/Write	Reset State	Comments	Config
Reserved	7:6	-			
cali_37	5:0	R	0	Auto Calibrate value of input 37 of ADC	

Register:: Cali_Value_38 (ACCESS[E4,E5] 0x38)					
Name	Bits	Read/Write	Reset State	Comments	Config
Reserved	7:6	-			
cali_38	5:0	R	0	Auto Calibrate value of input 38 of ADC	

Register:: Cali_Value_39 (ACCESS[E4,E5] 0x39)					
Name	Bits	Read/Write	Reset State	Comments	Config
Reserved	7:6	-			
cali_39	5:0	R	0	Auto Calibrate value of input 39 of ADC	

Register:: Cali_Value_3a (ACCESS[E4,E5] 0x3a)					
Name	Bits	Read/Write	Reset State	Comments	Config
Reserved	7:6	-			
cali_3a	5:0	R	0	Auto Calibrate value of input 3a of ADC	

Register:: Cali_Value_3b (ACCESS[E4,E5] 0x3b)					
Name	Bits	Read/Write	Reset State	Comments	Config
Reserved	7:6	-			
cali_3b	5:0	R	0	Auto Calibrate value of input 3b of ADC	

Register:: Cali_Value_3c (ACCESS[E4,E5] 0x3c)					
Name	Bits	Read/Write	Reset State	Comments	Config
Reserved	7:6	-			
cali_3c	5:0	R	0	Auto Calibrate value of input 3c of ADC	

Register:: Cali_Value_3d (ACCESS[E4,E5] 0x3d)					
Name	Bits	Read/Write	Reset State	Comments	Config
Reserved	7:6	-			
cali_3d	5:0	R	0	Auto Calibrate value of input 3d of ADC	

Register:: Cali_Value_3e (ACCESS[E4,E5] 0x3e)					
Name	Bits	Read/Write	Reset State	Comments	Config
Reserved	7:6	-			
cali_3e	5:0	R	0	Auto Calibrate value of input 3e of ADC	

Register:: Cali_Value_3f (ACCESS[E4,E5] 0x3f)					
Name	Bits	Read/Write	Reset State	Comments	Config
Reserved	7:6	-			
cali_3f	5:0	R	0	Auto Calibrate value of input 3f of ADC	

Realtek Confidential for GM Only

SOY Channel 1 Calibration Ctrl

Register:: SOYCH1_Cali_CFG0					0xf0
Name	Bits	Read/Write	Reset State	Comments	Config
fporch_val_sel	7:4	R	5	Select the output value of ADC data, before the rising edge of hsync. The base of fporch_val_sel is 4 clock cycle	
Reserved	3	-			
calibrate_cnt_base	2:0	R/W	4	Delay clock number to latch the output value of ADC for ADC output stable issue.	

Register:: SOYCH1_Cali_CFG1					0xf1												
Name	Bits	Read/Write	Reset State	Comments	Config												
Reserved	7:3	-															
calibrate_val_rst	2	R/W	0	Reset the value of look-up table of auto calibrate mode to initial vale. Initial value table list below. 1'b1 : Reset 1'b0 : Non-reset <table style="margin-left: 40px; border-collapse: collapse;"> <tr> <td style="padding-right: 20px;">DC_in</td> <td>Cali_out</td> </tr> <tr> <td>6'h0</td> <td>6'h0</td> </tr> <tr> <td>6'h1</td> <td>6'h1</td> </tr> <tr> <td>----</td> <td></td> </tr> <tr> <td>6'h3e</td> <td>6'h3e</td> </tr> <tr> <td>6'h3f</td> <td>6'h3f</td> </tr> </table>	DC_in	Cali_out	6'h0	6'h0	6'h1	6'h1	----		6'h3e	6'h3e	6'h3f	6'h3f	
DC_in	Cali_out																
6'h0	6'h0																
6'h1	6'h1																

6'h3e	6'h3e																
6'h3f	6'h3f																
auto_calibrate_int_en	1	R/W	0	Enable the interrupt of Auto calibrate done. 1'b1 : Enable 1'b0 : Disable													
auto_calibrate_en	0	R/W	0	Enable ADC/DAC Auto Calibrate mode. When auto-calibrate mode enable, SOY will generate 0-63 to DAC. SOY will latch the output value of ADC to generate look-up table. This look-up table will be used to fix the offset & gain error of ADC/DAC. 1'b0 : Disable 1'b1 : Enable													

Register:: SOYCH1_Cali_CFG2					0xf2
Name	Bits	Read/Write	Reset State	Comments	Config
fporch_val	7:2	R/W	0	The front porch value of SOY	
Reserved	3	-			
cali_done	0	R	0	Auto calibrate done indicator 1'b1 : Done 1'b0 : Progress	wclr_out

SOY Channel 1 Calibration Value

Register:: Cali_Value_PORT_ADDR					0xF4
Name	Bits	Read/Write	Reset State	Comments	Config
Reserved	7:6	-			
Cali_port_addr	5:0	R/W	0	Cali Value Access Port Address	

Register:: Cali_Value_PORT_DATA					0xF5
Name	Bits	Read/Write	Reset State	Comments	Config
Cali_port_data	7:0	R/W	0x00	Cali Value Access Port Data	

Register::Cali_Value_0					(ACCESS[F4,F5]) 0x00
Name	Bits	Read/Write	Reset State	Comments	Config
Reserved	7:6	-			
cali_0	5:0	R	0	Auto Calibrate value of input 0 of ADC	

Register:: Cali_Value_1					(ACCESS[F4,F5]) 0x01
Name	Bits	Read/Write	Reset State	Comments	Config
Reserved	7:6	-			
cali_1	5:0	R	0	Auto Calibrate value of input 1 of ADC	

Register:: Cali_Value_2					(ACCESS[F4,F5]) 0x02
Name	Bits	Read/Write	Reset State	Comments	Config
Reserved	7:6	-			
cali_2	5:0	R	0	Auto Calibrate value of input 2 of ADC	

Register:: Cali_Value_3					(ACCESS[F4,F5]) 0x03
Name	Bits	Read/Write	Reset State	Comments	Config
Reserved	7:6	-			

cali_3	5:0	R	0	Auto Calibrate value of input 3 of ADC	
--------	-----	---	---	--	--

Register:: Cali_Value_4 (ACCESS[F4,F5]) 0x04					
---	--	--	--	--	--

Name	Bits	Read/Write	Reset State	Comments	Config
Reserved	7:6	-			
cali_4	5:0	R	0	Auto Calibrate value of input 4 of ADC	

Register:: Cali_Value_5 (ACCESS[F4,F5]) 0x05					
---	--	--	--	--	--

Name	Bits	Read/Write	Reset State	Comments	Config
Reserved	7:6	-			
cali_5	5:0	R	0	Auto Calibrate value of input 5 of ADC	

Register:: Cali_Value_6 (ACCESS[F4,F5]) 0x06					
---	--	--	--	--	--

Name	Bits	Read/Write	Reset State	Comments	Config
Reserved	7:6	-			
cali_6	5:0	R	0	Auto Calibrate value of input 6 of ADC	

Register:: Cali_Value_7 (ACCESS[F4,F5]) 0x07					
---	--	--	--	--	--

Name	Bits	Read/Write	Reset State	Comments	Config
Reserved	7:6	-			
cali_7	5:0	R	0	Auto Calibrate value of input 7 of ADC	

Register:: Cali_Value_8 (ACCESS[F4,F5]) 0x08					
---	--	--	--	--	--

Name	Bits	Read/Write	Reset State	Comments	Config
Reserved	7:6	-			
cali_8	5:0	R	0	Auto Calibrate value of input 8 of ADC	

Register:: Cali_Value_9 (ACCESS[F4,F5]) 0x09					
---	--	--	--	--	--

Name	Bits	Read/Write	Reset State	Comments	Config
Reserved	7:6	-			
cali_9	5:0	R	0	Auto Calibrate value of input 9 of ADC	

Register:: Cali_Value_a (ACCESS[F4,F5]) 0x0a					
---	--	--	--	--	--

Name	Bits	Read/Write	Reset State	Comments	Config
Reserved	7:6	-			

cali_a	5:0	R	0	Auto Calibrate value of input a of ADC	
--------	-----	---	---	--	--

Register:: Cali_Value_b (ACCESS[F4,F5]) 0x0b					
---	--	--	--	--	--

Name	Bits	Read/Write	Reset State	Comments	Config
Reserved	7:6	-			
cali_b	5:0	R	0	Auto Calibrate value of input b of ADC	

Register:: Cali_Value_c (ACCESS[F4,F5]) 0x0c					
---	--	--	--	--	--

Name	Bits	Read/Write	Reset State	Comments	Config
Reserved	7:6	-			
cali_c	5:0	R	0	Auto Calibrate value of input c of ADC	

Register:: Cali_Value_d (ACCESS[F4,F5]) 0x0d					
---	--	--	--	--	--

Name	Bits	Read/Write	Reset State	Comments	Config
Reserved	7:6	-			
cali_d	5:0	R	0	Auto Calibrate value of input d of ADC	

Register:: Cali_Value_e (ACCESS[F4,F5]) 0x0e					
---	--	--	--	--	--

Name	Bits	Read/Write	Reset State	Comments	Config
Reserved	7:6	-			
cali_e	5:0	R	0	Auto Calibrate value of input e of ADC	

Register:: Cali_Value_f (ACCESS[F4,F5]) 0x0f					
---	--	--	--	--	--

Name	Bits	Read/Write	Reset State	Comments	Config
Reserved	7:6	-			
cali_f	5:0	R	0	Auto Calibrate value of input f of ADC	

Register:: Cali_Value_10 (ACCESS[F4,F5]) 0x10					
--	--	--	--	--	--

Name	Bits	Read/Write	Reset State	Comments	Config
Reserved	7:6	-			
cali_10	5:0	R	0	Auto Calibrate value of input 10 of ADC	

Register:: Cali_Value_11 (ACCESS[F4,F5]) 0x11					
--	--	--	--	--	--

Name	Bits	Read/Write	Reset State	Comments	Config
Reserved	7:6	-			

cali_11	5:0	R	0	Auto Calibrate value of input 11 of ADC	
---------	-----	---	---	---	--

Register:: Cali_Value_12				(ACCESS[F4,F5]) 0x12	
---------------------------------	--	--	--	-----------------------------	--

Name	Bits	Read/Write	Reset State	Comments	Config
Reserved	7:6	-			
cali_12	5:0	R	0	Auto Calibrate value of input 12 of ADC	

Register:: Cali_Value_13				(ACCESS[F4,F5]) 0x13	
---------------------------------	--	--	--	-----------------------------	--

Name	Bits	Read/Write	Reset State	Comments	Config
Reserved	7:6	-			
cali_13	5:0	R	0	Auto Calibrate value of input 13 of ADC	

Register:: Cali_Value_14				(ACCESS[F4,F5]) 0x14	
---------------------------------	--	--	--	-----------------------------	--

Name	Bits	Read/Write	Reset State	Comments	Config
Reserved	7:6	-			
cali_14	5:0	R	0	Auto Calibrate value of input 14 of ADC	

Register:: Cali_Value_15				(ACCESS[F4,F5]) 0x15	
---------------------------------	--	--	--	-----------------------------	--

Name	Bits	Read/Write	Reset State	Comments	Config
Reserved	7:6	-			
cali_15	5:0	R	0	Auto Calibrate value of input 15 of ADC	

Register:: Cali_Value_16				(ACCESS[F4,F5]) 0x16	
---------------------------------	--	--	--	-----------------------------	--

Name	Bits	Read/Write	Reset State	Comments	Config
Reserved	7:6	-			
cali_16	5:0	R	0	Auto Calibrate value of input 16 of ADC	

Register:: Cali_Value_17				(ACCESS[F4,F5]) 0x17	
---------------------------------	--	--	--	-----------------------------	--

Name	Bits	Read/Write	Reset State	Comments	Config
Reserved	7:6	-			
cali_17	5:0	R	0	Auto Calibrate value of input 17 of ADC	

Register:: Cali_Value_18				(ACCESS[F4,F5]) 0x18	
---------------------------------	--	--	--	-----------------------------	--

Name	Bits	Read/Write	Reset State	Comments	Config
Reserved	7:6	-			

cali_18	5:0	R	0	Auto Calibrate value of input 18 of ADC	
---------	-----	---	---	---	--

Register:: Cali_Value_19				(ACCESS[F4,F5]) 0x19	
---------------------------------	--	--	--	-----------------------------	--

Name	Bits	Read/Write	Reset State	Comments	Config
Reserved	7:6	-			
cali_19	5:0	R	0	Auto Calibrate value of input 19 of ADC	

Register:: Cali_Value_1a				(ACCESS[F4,F5]) 0x1a	
---------------------------------	--	--	--	-----------------------------	--

Name	Bits	Read/Write	Reset State	Comments	Config
Reserved	7:6	-			
cali_1a	5:0	R	0	Auto Calibrate value of input 1a of ADC	

Register:: Cali_Value_1b				(ACCESS[F4,F5]) 0x1b	
---------------------------------	--	--	--	-----------------------------	--

Name	Bits	Read/Write	Reset State	Comments	Config
Reserved	7:6	-			
cali_1b	5:0	R	0	Auto Calibrate value of input 1b of ADC	

Register:: Cali_Value_1c				(ACCESS[F4,F5]) 0x1c	
---------------------------------	--	--	--	-----------------------------	--

Name	Bits	Read/Write	Reset State	Comments	Config
Reserved	7:6	-			
cali_1c	5:0	R	0	Auto Calibrate value of input 1c of ADC	

Register:: Cali_Value_1d				(ACCESS[F4,F5]) 0x1d	
---------------------------------	--	--	--	-----------------------------	--

Name	Bits	Read/Write	Reset State	Comments	Config
Reserved	7:6	-			
cali_1d	5:0	R	0	Auto Calibrate value of input 1d of ADC	

Register:: Cali_Value_1e				(ACCESS[F4,F5]) 0x1e	
---------------------------------	--	--	--	-----------------------------	--

Name	Bits	Read/Write	Reset State	Comments	Config
Reserved	7:6	-			
cali_1e	5:0	R	0	Auto Calibrate value of input 1e of ADC	

Register:: Cali_Value_1f				(ACCESS[F4,F5]) 0x1f	
---------------------------------	--	--	--	-----------------------------	--

Name	Bits	Read/Write	Reset State	Comments	Config
Reserved	7:6	-			

cali_1f	5:0	R	0	Auto Calibrate value of input 1f of ADC	
---------	-----	---	---	---	--

Register:: Cali_Value_20				(ACCESS[F4,F5]) 0x20	
---------------------------------	--	--	--	-----------------------------	--

Name	Bits	Read/Write	Reset State	Comments	Config
Reserved	7:6	-			
cali_20	5:0	R	0	Auto Calibrate value of input 20 of ADC	

Register:: Cali_Value_21				(ACCESS[F4,F5]) 0x21	
---------------------------------	--	--	--	-----------------------------	--

Name	Bits	Read/Write	Reset State	Comments	Config
Reserved	7:6	-			
cali_21	5:0	R	0	Auto Calibrate value of input 21 of ADC	

Register:: Cali_Value_22				(ACCESS[F4,F5]) 0x22	
---------------------------------	--	--	--	-----------------------------	--

Name	Bits	Read/Write	Reset State	Comments	Config
Reserved	7:6	-			
cali_22	5:0	R	0	Auto Calibrate value of input 22 of ADC	

Register:: Cali_Value_23				(ACCESS[F4,F5]) 0x23	
---------------------------------	--	--	--	-----------------------------	--

Name	Bits	Read/Write	Reset State	Comments	Config
Reserved	7:6	-			
cali_23	5:0	R	0	Auto Calibrate value of input 23 of ADC	

Register:: Cali_Value_24				(ACCESS[F4,F5]) 0x24	
---------------------------------	--	--	--	-----------------------------	--

Name	Bits	Read/Write	Reset State	Comments	Config
Reserved	7:6	-			
cali_24	5:0	R	0	Auto Calibrate value of input 24 of ADC	

Register:: Cali_Value_25				(ACCESS[F4,F5]) 0x25	
---------------------------------	--	--	--	-----------------------------	--

Name	Bits	Read/Write	Reset State	Comments	Config
Reserved	7:6	-			
cali_25	5:0	R	0	Auto Calibrate value of input 25 of ADC	

Register:: Cali_Value_26				(ACCESS[F4,F5]) 0x26	
---------------------------------	--	--	--	-----------------------------	--

Name	Bits	Read/Write	Reset State	Comments	Config
Reserved	7:6	-			

cali_26	5:0	R	0	Auto Calibrate value of input 26 of ADC	
---------	-----	---	---	---	--

Register:: Cali_Value_27				(ACCESS[F4,F5]) 0x27	
---------------------------------	--	--	--	-----------------------------	--

Name	Bits	Read/Write	Reset State	Comments	Config
Reserved	7:6	-			
cali_27	5:0	R	0	Auto Calibrate value of input 27 of ADC	

Register:: Cali_Value_28				(ACCESS[F4,F5]) 0x28	
---------------------------------	--	--	--	-----------------------------	--

Name	Bits	Read/Write	Reset State	Comments	Config
Reserved	7:6	-			
cali_28	5:0	R	0	Auto Calibrate value of input 28 of ADC	

Register:: Cali_Value_29				(ACCESS[F4,F5]) 0x29	
---------------------------------	--	--	--	-----------------------------	--

Name	Bits	Read/Write	Reset State	Comments	Config
Reserved	7:6	-			
cali_29	5:0	R	0	Auto Calibrate value of input 29 of ADC	

Register:: Cali_Value_2a				(ACCESS[F4,F5]) 0x2a	
---------------------------------	--	--	--	-----------------------------	--

Name	Bits	Read/Write	Reset State	Comments	Config
Reserved	7:6	-			
cali_2a	5:0	R	0	Auto Calibrate value of input 2a of ADC	

Register:: Cali_Value_2b				(ACCESS[F4,F5]) 0x2b	
---------------------------------	--	--	--	-----------------------------	--

Name	Bits	Read/Write	Reset State	Comments	Config
Reserved	7:6	-			
cali_2b	5:0	R	0	Auto Calibrate value of input 2b of ADC	

Register:: Cali_Value_2c				(ACCESS[F4,F5]) 0x2c	
---------------------------------	--	--	--	-----------------------------	--

Name	Bits	Read/Write	Reset State	Comments	Config
Reserved	7:6	-			
cali_2c	5:0	R	0	Auto Calibrate value of input 2c of ADC	

Register:: Cali_Value_2d				(ACCESS[F4,F5]) 0x2d	
---------------------------------	--	--	--	-----------------------------	--

Name	Bits	Read/Write	Reset State	Comments	Config
Reserved	7:6	-			

cali_2d	5:0	R	0	Auto Calibrate value of input 2d of ADC	
---------	-----	---	---	---	--

Register:: Cali_Value_2e				(ACCESS[F4,F5]) 0x2e	
---------------------------------	--	--	--	-----------------------------	--

Name	Bits	Read/Write	Reset State	Comments	Config
Reserved	7:6	-			
cali_2e	5:0	R	0	Auto Calibrate value of input 2e of ADC	

Register:: Cali_Value_2f				(ACCESS[F4,F5]) 0x2f	
---------------------------------	--	--	--	-----------------------------	--

Name	Bits	Read/Write	Reset State	Comments	Config
Reserved	7:6	-			
cali_2f	5:0	R	0	Auto Calibrate value of input 2f of ADC	

Register:: Cali_Value_30				(ACCESS[F4,F5]) 0x30	
---------------------------------	--	--	--	-----------------------------	--

Name	Bits	Read/Write	Reset State	Comments	Config
Reserved	7:6	-			
cali_30	5:0	R	0	Auto Calibrate value of input 30 of ADC	

Register:: Cali_Value_31				(ACCESS[F4,F5]) 0x31	
---------------------------------	--	--	--	-----------------------------	--

Name	Bits	Read/Write	Reset State	Comments	Config
Reserved	7:6	-			
cali_31	5:0	R	0	Auto Calibrate value of input 31 of ADC	

Register:: Cali_Value_32				(ACCESS[F4,F5]) 0x32	
---------------------------------	--	--	--	-----------------------------	--

Name	Bits	Read/Write	Reset State	Comments	Config
Reserved	7:6	-			
cali_32	5:0	R	0	Auto Calibrate value of input 32 of ADC	

Register:: Cali_Value_33				(ACCESS[F4,F5]) 0x33	
---------------------------------	--	--	--	-----------------------------	--

Name	Bits	Read/Write	Reset State	Comments	Config
Reserved	7:6	-			
cali_33	5:0	R	0	Auto Calibrate value of input 33 of ADC	

Register:: Cali_Value_34				(ACCESS[F4,F5]) 0x34	
---------------------------------	--	--	--	-----------------------------	--

Name	Bits	Read/Write	Reset State	Comments	Config
Reserved	7:6	-			

cali_34	5:0	R	0	Auto Calibrate value of input 34 of ADC	
---------	-----	---	---	---	--

Register:: Cali_Value_35				(ACCESS[F4,F5]) 0x35	
---------------------------------	--	--	--	-----------------------------	--

Name	Bits	Read/Write	Reset State	Comments	Config
Reserved	7:6	-			
cali_35	5:0	R	0	Auto Calibrate value of input 35 of ADC	

Register:: Cali_Value_36				(ACCESS[F4,F5]) 0x36	
---------------------------------	--	--	--	-----------------------------	--

Name	Bits	Read/Write	Reset State	Comments	Config
Reserved	7:6	-			
cali_36	5:0	R	0	Auto Calibrate value of input 36 of ADC	

Register:: Cali_Value_37				(ACCESS[F4,F5]) 0x37	
---------------------------------	--	--	--	-----------------------------	--

Name	Bits	Read/Write	Reset State	Comments	Config
Reserved	7:6	-			
cali_37	5:0	R	0	Auto Calibrate value of input 37 of ADC	

Register:: Cali_Value_38				(ACCESS[F4,F5]) 0x38	
---------------------------------	--	--	--	-----------------------------	--

Name	Bits	Read/Write	Reset State	Comments	Config
Reserved	7:6	-			
cali_38	5:0	R	0	Auto Calibrate value of input 38 of ADC	

Register:: Cali_Value_39				(ACCESS[F4,F5]) 0x39	
---------------------------------	--	--	--	-----------------------------	--

Name	Bits	Read/Write	Reset State	Comments	Config
Reserved	7:6	-			
cali_39	5:0	R	0	Auto Calibrate value of input 39 of ADC	

Register:: Cali_Value_3a				(ACCESS[F4,F5]) 0x3a	
---------------------------------	--	--	--	-----------------------------	--

Name	Bits	Read/Write	Reset State	Comments	Config
Reserved	7:6	-			
cali_3a	5:0	R	0	Auto Calibrate value of input 3a of ADC	

Register:: Cali_Value_3b				(ACCESS[F4,F5]) 0x3b	
---------------------------------	--	--	--	-----------------------------	--

Name	Bits	Read/Write	Reset State	Comments	Config
Reserved	7:6	-			

cali_3b	5:0	R	0	Auto Calibrate value of input 3b of ADC	
---------	-----	---	---	---	--

Register:: Cali_Value_3c				(ACCESS[F4,F5]) 0x3c	
---------------------------------	--	--	--	-----------------------------	--

Name	Bits	Read/Write	Reset State	Comments	Config
Reserved	7:6	-			
cali_3c	5:0	R	0	Auto Calibrate value of input 3c of ADC	

Register:: Cali_Value_3d				(ACCESS[F4,F5]) 0x3d	
---------------------------------	--	--	--	-----------------------------	--

Name	Bits	Read/Write	Reset State	Comments	Config
Reserved	7:6	-			
cali_3d	5:0	R	0	Auto Calibrate value of input 3d of ADC	

Register:: Cali_Value_3e				(ACCESS[F4,F5]) 0x3e	
---------------------------------	--	--	--	-----------------------------	--

Name	Bits	Read/Write	Reset State	Comments	Config
Reserved	7:6	-			
cali_3e	5:0	R	0	Auto Calibrate value of input 3e of ADC	

Register:: Cali_Value_3f				(ACCESS[F4,F5]) 0x3f	
---------------------------------	--	--	--	-----------------------------	--

Name	Bits	Read/Write	Reset State	Comments	Config
Reserved	7:6	-			
cali_3f	5:0	R	0	Auto Calibrate value of input 3f of ADC	

Reserved page

MCU register 1(page D)

Embedded MCU Function

Designware DW8051 of Synopsys is integrated into this chip and is compatible with other industry 8051 series. A lot of peripherals are integrated and accessed by XFR (eXternal Function Register). When embedded MCU is used, scalar-related registers are access via XFR, too. The program code is stored in external serial FLASH. If the external MCU is used, the integrated peripherals can be accessed via special page in scalar's register map.

Features

- | 8051 core, CPU operating frequency up to 50MHz
- | 256-byte IRAM, 256~1024 byte shared XRAM
- | external serial FLASH, support GPIO bank switching for 128K byte and up to 16M bytes for XFR bank switching
- | Compliant with VESA DDC1/2B/2Bi/CI
- | Embedded triple ports DDC RAM(0~768 bytes shared with X-RAM)
- | Six channels of PWM DAC
- | Watchdog timer with programmable interval
- | Three 16-bit counters/timers (T0, T1, and ET2)
- | Programmable frequency clock output, 2 clock output ports
- | One full-duplex serial port
- | Six interrupt sources with 2 external interrupts
- | Five channels of 6-bit ADC, Three channels of 10-bit ADC
- | Hardware ISP, no boot code required
- | Built-in Low voltage reset circuit

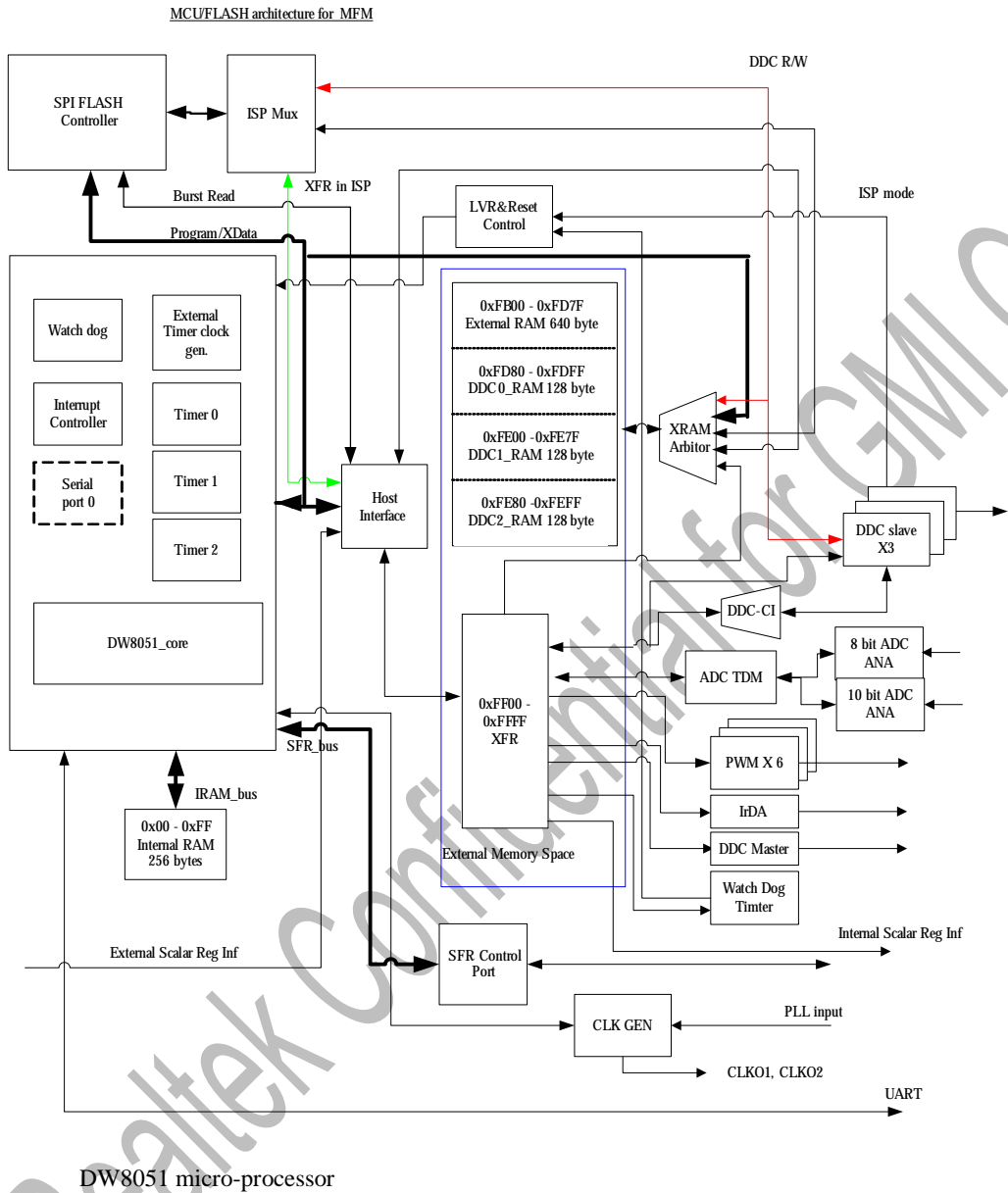

The DW8051 is compatible with industry standard 803x/805x and provides the following design features and enhancements to the standard 8051 microcontroller:

High speed architecture

Compared to standard 8051, the DW8051 processor core provides increased performance by executing instructions in a 4-clock bus cycle, as opposed to the

12-clock bus cycle in the standard 8051. The shortened bus timing improves the instruction execution rate for most instructions by a factor of three over the standard 8051 architectures. The average speed improvement for the entire instruction set is approximately 2.5X.

Stretch Memory Cycles

The stretch memory cycle feature enables application software to adjust the speed of data memory access. The DW8051 can execute the MOVX instruction in as little as 2 instruction cycles. However, it is sometimes desirable to stretch this value; for example, to access slow memory or slow memory-mapped peripherals such as UARTs or LCDs.

The three LSBs of the Clock Control Register (at SFR location 8Eh) control the stretch value. You can use stretch values between zero and seven. A stretch value of zero adds zero instruction cycles, resulting in MOVX instructions executing in two instruction cycles. A stretch value of seven adds seven instruction cycles, resulting in MOVX instructions executing in nine instruction cycles. The stretch value can be changed dynamically under program control.

By default, the stretch value resets to one (three cycle MOVX). For full-speed data memory access, the software must set the stretch value to zero. The stretch value affects only data memory access. The only way to reduce the speed of program memory (ROM) access is to use a slower clock.

Dual Data Pointers

The DW8051 employs dual data pointers to accelerate data memory block moves. The standard 8051 data pointer (DPTR) is a 16-bit value used to address external data RAM or peripherals. The DW8051 maintains the standard data pointer as DPTR0 at SFR locations 82h and 83h. It is not necessary to modify code to use DPTR0.

The DW8051 adds a second data pointer (DPTR1) at SFR locations 84h and 85h. The SEL bit in the DPTR Select register, DPS (SFR 86h), selects the active pointer. When SEL = 0, instructions that use the DPTR will use DPL0 and DPH0. When SEL = 1, instructions that use the DPTR will use DPL1 and DPH1. SEL is the bit 0 of SFR location 86h. No other bits of SFR location 86h are used.

All DPTR-related instructions use the currently selected data pointer. To switch the active pointer, toggle the SEL bit. The fastest way to do so is to use the increment instruction (INC DPS). This requires only one instruction to switch from a source address to a destination address, saving application code from having to save source and destination addresses when doing a block move.

Using dual data pointers provides significantly increased efficiency when moving large blocks of data.

Timer Rate Control

One important difference exists between the DW8051 and 80C32 regarding timers. The original 80C32 used a 12 clock per cycle scheme for timers and consequently for some serial baud rates (depending on the mode). The DW8051 architecture normally runs using 4 clocks per cycle. However, in the area of timers, it will default to a 12 clock per cycle scheme on a reset. This allows existing code with real-time dependencies such as baud rates to operate properly. If an application needs higher speed timers or serial baud rates, the timers can be set to run at the 4 clock rate. The Clock Control register (CKCON – 8Eh) determines these timer speeds. When the relevant CKCON bit is a logic 1, the device uses 4 clocks per cycle to generate timer speeds. When the control bit is set to a zero, the device uses 12 clocks for timer speeds. The reset condition is a 0. CKCON.5 selects the speed of Timer 2. CKCON.4 selects Timer 1 and CKCON.3 selects Timer zero. Note that unless a user desires very fast timing, it is unnecessary to alter these bits. Note that the timer controls are independent.

RESET

There are five reset sources.

I RST pin

The external reset is high active and its pulse width must be larger than 8 clock cycles. The RST pin can reset the DW8051.

I Low voltage reset(LVR) and power on reset(POR)

I Software can use SOF_RST register to reset whole chip

I Watchdog can reset DW8051

I When entering ISP mode, DW8051 will in reset state. When exiting ISP mode, DW8051 will also asserting a reset, too.

Special Function Registers

Register	Bit 7	Bit 6	Bit 5	Bit 4	Bit 3	Bit 2	Bit 1	Bit 0	Addr
SP									81h
DPL0									82h
DPH0									83h
DPL1									84h
DPH1									85h
DPS	0	0	0	0	0	0	0	SEL	86h

PCON	SMOD 0		1	1	GF1	GF0	STOP	IDLE	87h
TCON	TF1	TR1	TF0	TR0	IE1	IT1	IE0	IT0	88h
TMOD	GATE	C/T	M1	M0	GATE	C/T	M1	M0	89h
TL0									8Ah
TL1									8Bh
TH0									8Ch
TH1									8Dh
CKCON			T2M	T1M	T0M	MD2	MD1	MD0	8Eh
SPC_FNC	0	0	0	0	0	0	0	WRS	8Fh
P1	P1.7	P1.6	P1.5	P1.4	P1.3	P1.2	P1.1	P1.0	90h
MPAGE									92h
SCON0	SM0	SM1	SM2	REN	TB8	RB8	TI	RI	98h
SBUF0									99h
P2	P2.7	P2.6	P2.5	P2.4	P2.3	P2.2	P2.1	P2.0	A0h
IE	EA	0	ET2	ES0	ET1	EX1	ET0	EX0	A8h
P3	P3.7	P3.6	P3.5	P3.4	P3.3	P3.2	P3.1	P3.0	B0h
IP	1	0	PT2	PS0	PT1	PX1	PT0	PX0	B8h
T2CON	TF2	EXF2	RCLK	TCLK	EXEN2	TR2	C/T2	CP/ RL2	C8h
RCAP2L									CAh
RCAP2H									CBh
TL2									CCh
TH2									CDh
PSW	CY	AC	F0	RS1	RS0	OV	F1	P	D0h
ACC									E0h
B									F0h

Note: WRS of SPC_FNC register is tied zero. MPAGE is not used if we implement P2. 藍色部分為DW8051有的而 standard 8051沒有的.紅色部分為DW8051沒有的而 standard 8051有,但也用不到,所以 final spec 也不會列出. 橘色部分為DW8051沒有而我們必須 implement 的部分.

SFR reset value

Register	Bit 7	Bit 6	Bit 5	Bit 4	Bit 3	Bit 2	Bit 1	Bit 0	Addr
SP	0	0	0	0	0	1	1	1	81h

DPL0	0	0	0	0	0	0	0	0	82h
DPH0	0	0	0	0	0	0	0	0	83h
DPL1	0	0	0	0	0	0	0	0	84h
DPH1	0	0	0	0	0	0	0	0	85h
DPS	0	0	0	0	0	0	0	0	86h
PCON	0	0	1	1	0	0	0	0	87h
TCON	0	0	0	0	0	0	0	0	88h
TMOD	0	0	0	0	0	0	0	0	89h
TL0	0	0	0	0	0	0	0	0	8Ah
TL1	0	0	0	0	0	0	0	0	8Bh
TH0	0	0	0	0	0	0	0	0	8Ch
TH1	0	0	0	0	0	0	0	0	8Dh
CKCON	0	0	0	0	0	0	0	1	8Eh
SPC_FNC	0	0	0	0	0	0	0	0	8Fh
P1_W	1	1	1	1	1	1	1	1	90h
MPAGE	0	0	0	0	0	0	0	0	92h
P1_R	1	1	1	1	1	1	1	1	93h
SCON0	0	0	0	0	0	0	0	0	98h
SBUF0	0	0	0	0	0	0	0	0	99h
P2	0	0	0	0	0	0	0	0	A0h
IE	0	0	0	0	0	0	0	0	A8h
P3_W	1	1	1	1	1	1	1	1	B0h
P3_R	1	1	1	1	1	1	1	1	B3h
IP	1	0	0	0	0	0	0	0	B8h
T2CON	0	0	0	0	0	0	0	0	C8h
RCAP2L	0	0	0	0	0	0	0	0	CAh
RCAP2H	0	0	0	0	0	0	0	0	CBh
TL2	0	0	0	0	0	0	0	0	CCh
TH2	0	0	0	0	0	0	0	0	CDh
PSW	0	0	0	0	0	0	0	0	D0h
ACC	0	0	0	0	0	0	0	0	E0h
B	0	0	0	0	0	0	0	0	F0h

DW8051 user-modifiable parameters

ram_256	1
---------	---

timer2	1
rom_addr_size	0
Serial	1
extd_intr	0

REG_XFR_WRAPPER is the eXternal Function Register defined in 0xFF00 ~ 0xFFFF in DW8051's XDATA memory space. There are three possible input sources for REG_XFR_WRAPPER. In embedded MCU mode, DW8051 has the power of control.

0xFFXX	PAGE D						PAGE E						PAGE F			
	A	B	C	D	E	F	A	B	C	D	E	F	A	B	C	D
0	GPIO															
1																
2															SFR, P1	
3															P3	
4																
5																
6									Pin share							
7																
8																
9																
A															0x36	
B											CEC					
C															0x37	
D															0x38	
E															0x39	
F															0x40	

In external MCU mode, external host interface has the privilege to access REG_XFR_WRAPPER. The total 256 addresses are separated into 3 pages. 0xFF00 ~ 0xFF5F is Page D, 0xFF60 ~ 0xFFBF is Page E and 0xFFC0 ~ 0xFFFF is Page F. External host control signals are passed to scalar register interface. Host interface must integrate the output of scalar interface and REG_XFR_WRAPPER depends on page selection.

When ISP is activated, REG_XFR_WRAPPER is accessed by ISP interface, it has the highest priority. DW8051 and external host is selected by power-on-latch signal, ext_host_sel.

Interrupt Control

Register::IRQ_Status		0xFF00				
Name	Bits	R/W	Default	Comments	Config	
Reserved	7	--	--	Reserved		
M2PLL_IRQ_EVENT	6	R/W	0	M2PLL-abnormal Event Status 1. Select M2PLL as clock source, but M2PLL power down, power saving or output disable, clear this bit to disable the interrupt	Rport Wport	
CEC_IRQ_EVENT	5	R/W	0	CEC Event Status 1. IF CEC func IRQ event occurred since the last status cleared	Rport Wport	
SCA_IRQ_EVENT	4	R/W	0	Scalar-related Event Status 1. IF Scalar integrated IRQ event occurred since the last status cleared	Rport Wport	
I2CM_IRQ_EVENT	3	R/W	0	I2C Master Event Status 1. IF I2C Master IRQ event occurred since the last status cleared	Rport Wport	
ADC_IRQ_EVENT	2	R/W	0	ADC Event Status 1: If the ADC IRQ event occurred since the last status cleared	Rport Wport	
IrDA_IRQ_EVENT	1	R/W	0	IrDA Event Status 1: If the IrDA IRQ event occurred since the last status cleared	Rport Wport	
DDC_IRQ_EVENT	0	R/W	0	DDC Event Status 1: If the DDC IRQ event occurred since the last status cleared	Rport Wport	

Register::IRQ_Priority		0xFF01				
Name	Bits	R/W	Default	Comments	Config	
Reserved	7	--	--	Reserved		

M2PLL_IRQ_PRI	6	R/W	0	M2PLL-abnormal IRQ Priority 0: Connected to int0 1: Connected to int1	
CEC_IRQ_PRI	5	R/W	0	CEC IRQ Priority 0: Connected to int0 1: Connected to int1	
SCA_IRQ_PRI	4	R/W	0	Scalar integrated IRQ Priority 0: Connected to int0 1: Connected to int1	
I2CM_IRQ_PRI	3	R/W	0	I2C Master IRQ Priority 0: Connected to int0 1: Connected to int1	
ADC_IRQ_PRI	2	R/W	0	ADC IRQ Priority 0: Connected to int0 1: Connected to int1	
IrDA_IRQ_PRI	1	R/W	0	IrDA IRQ Priority 0: Connected to int0 1: Connected to int1	
DDC_IRQ_PRI	0	R/W	0	DDC IRQ Priority 0: Connected to int0 1: Connected to int1	

Register:: REV_DUMMY1		0xFF02			
Name	Bits	R/W	Default	Comments	Config
REV_DUMMY1	7:0	R/W	00	Dummy1	

ADC

A/D Converter

RTD2662 has embedded 5 channels of analog-to-digital converter by A_circuit. The ADCs_ACKT convert analog input voltage on the five A/D input pins to five 6-bit digital data stored in XFRs (FF09 ~ FF0D) sequentially.

The ADC conversion range is from GND to VDD and the conversion is linear and monotonic with no missing codes. To start A/D conversion, set STRT_ADC_ACKT = 1 and the conversion will be

completed in less than 12us for 5 channels.

ADC_Ackt block diagram (for Key Sensing, D-connector)

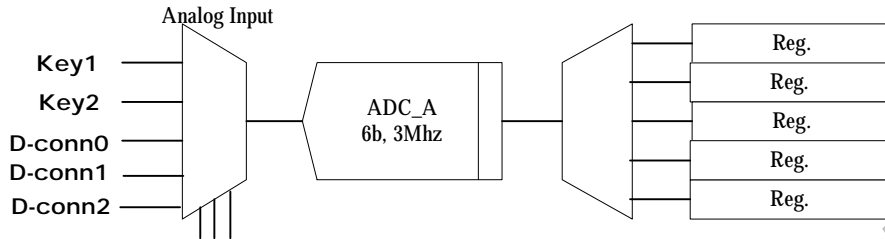

Register::ADC_Acontrol				0xFF08	
Name	Bits	R/W	Default	Comments	Config
STRT_ADC_ACKT	7	R/W	0	Write 1 to start the A/D conversion. Auto clear when A/D Conversion has been completed. 0:A/D Conversion has been completed 1:A/D Conversion is not completed yet	Rport Wport
ADC_ATEST	6	R/W	0	0: Normal operation 1: ADC test mode	
ADC_A_DUMMY	5:3	R/W	0	Dummy Registers	
ADC_B_BIAS_ADJ	2:1	R/W	1	ADC bias current adjust 00: 15u 01: 20u 10: 25u 11: 30u	
ADC_A_CK_SEL	0	R/W	0	Inverse ADC input clock pos/neg 0: pos 1: neg	

Register::ADC_A0_convert_result				0xFF09	
Name	Bits	R/W	Default	Comments	Config
ADC_A0_DATA	7:2	R	3F	Converted data of ADC_A0	
reserved	1:0	--	00	Reserved	

Register::ADC_A1_convert_result					0xFF0A	
Name	Bits	R/W	Default	Comments	Config	
ADC_A1_DATA	7:2	R	3F	Converted data of ADC_A1		
reserved	1:0	--	00			

Register::ADC_A2_convert_result					0xFF0B	
Name	Bits	R/W	Default	Comments	Config	
ADC_A2_DATA	7:2	R	3F	Converted data of ADC_A2		
reserved	1:0	--	00			

Register::ADC_A3_convert_result					0xFF0C	
Name	Bits	R/W	Default	Comments	Config	
ADC_A3_DATA	7:2	R	3F	Converted data of ADC_A3		
reserved	1:0	--	00			

Register::ADC_A4_convert_result					0xFF0D	
Name	Bits	R/W	Default	Comments	Config	
ADC_A4_DATA	7:2	R	3F	Converted data of ADC_A4		
reserved	1:0	--	00			

Register::ADC_B_control					0xFF0E	
Name	Bits	R/W	Default	Comments	Config	
STRT_ADC_BCKT	7	R/W	0	Write 1 to start the A/D conversion. Auto clear when A/D Conversion has been completed in single mode. 0:A/D Conversion has been completed 1:A/D Conversion is not completed yet	Rport Wport	
ADC_BTEST	6	R/W	0	0: Normal operation 1: ADC test mode		
ADC_B_MOD_SEL	5	R/W	0	0: single mode 1: continuous mode		

ADC_B_EN_INT	4	R/W	0	Meas.- target \geq threshold, de-bounce 0: disable INT 1: enable INT It will be clear INT flag when you read this reg.	
ADC_B_EN_DEBU	3	R/W	0	0: disable de-bounce 1: enable de-bounce at 3 times	
ADC_B_BIAS_ADJ	2:1	R/W	1	ADC bias current adjust 00: 15u 01: 20u 10: 25u 11: 30u	
ADC_B_CK_SEL	0	R/W	0	Inverse ADC input clock pos/neg 0: pos 1: neg	

Register::THRESHOLD_VALUE					0xFF0F
Name	Bits	R/W	Default	Comments	Config
ADC_B_THRESHOLD	7:0	R/W	00	threshold value for continued mode, Max. threshold=255	

Register::TARGET0_HIGH_VALUE					0xFF10
Name	Bits	R/W	Default	Comments	Config
ADC_B0_TARGET_HI	7:0	R/W	00	Compare target value for continued mode, ADC_Bx_TARGET[9:2]	

Register::TARGET1_HI_VALUE					0xFF11
Name	Bits	R/W	Default	Comments	Config
ADC_B1_TARGET_HI	7:0	R/W	00	Compare target value for continued mode, ADC_Bx_TARGET[9:2]	

Register::TARGET2_HI_VALUE					0xFF12
Name	Bits	R/W	Default	Comments	Config
ADC_B2_TARGET_HI	7:0	R/W	00	Compare target value for continued mode, ADC_Bx_TARGET[9:2]	

Register::MEAS_T_LO_VALUE					0xFF13
Name	Bits	R/W	Default	Comments	Config

ADC_B_MEAS_T_HI	7:0	R/W	00	User time/ 10us, 0us < user time < 10ms	
-----------------	-----	-----	----	---	--

Register::TARGET_MEAS_LO_VALUE						0xFF14
Name	Bits	R/W	Default	Comments	Config	
ADC_B0_TARGET_LO	7:6	R/W	00	Compare target value for continued mode, ADC_Bx_TARGET[1:0]		
ADC_B1_TARGET_LO	5:4	R/W	00	Compare target value for continued mode, ADC_Bx_TARGET[1:0]		
ADC_B2_TARGET_LO	3:2	R/W	00	Compare target value for continued mode, ADC_Bx_TARGET[1:0]		
ADC_B_MEAS_T_LO	1:0	R/W	00	User time/ 10us , 0us < user time < 10ms		

Register::ADC_B0H_convert_result						0xFF15
Name	Bits	R/W	Default	Comments	Config	
ADC_B0_DATAH	7:0	R	FF	Converted data of ADC_B0H, ADC_Bx_DATA[9:2]		

Register::ADC_B1H_convert_result						0xFF16
Name	Bits	R/W	Default	Comments	Config	
ADC_B1_DATAH	7:0	R	FF	Converted data of ADC_B1H, ADC_Bx_DATA[9:2]		

Register::ADC_B2H_convert_result						0xFF17
Name	Bits	R/W	Default	Comments	Config	
ADC_B2_DATAH	7:0	R	FF	Converted data of ADC_B2H, ADC_Bx_DATA[9:2]		

Register::ADC_BxL_convert_result						0xFF18
Name	Bits	R/W	Default	Comments	Config	
ADC_B0_DATA_L	7:6	R	3	Converted data of ADC_B0L, ADC_Bx_DATA[1:0]		
ADC_B1_DATA_L	5:4	R	3	Converted data of ADC_B1L, ADC_Bx_DATA[1:0]		
ADC_B2_DATA_L	3:2	R	3	Converted data of ADC_B2L, ADC_Bx_DATA[1:0]		

reserved	1:0	R/W	0	Reserved	
----------	-----	-----	---	----------	--

Register:: REV_DUMMY2				0xFF19	
Name	Bits	R/W	Default	Comments	Config
REV_DUMMY2	7:0	R/W	00	Dummy2	

DDC

RTD2662 has three DDC ports. The MCU can access the following three DDC interface:

- I DDC_RAM1 (FD80~FDFF) through pin ASDL and ASDA by ADC DDC channel.
- I DDC_RAM2 (FE00~FE7F) through pin DSDL and DSDA by DDC2 channel.
- I DDC_RAM3 (FE80~FEFF) through pin HSDL and HSDA by DDC3 channel.

Besides, the DDC_RAM1, DDC_RAM2, DDC_RAM3 can be assigned from 128 to 256bytes. The actual sizes of each DDC_RAM are determined by the combination of ADDCRAM_ST, DDDCRAM_ST, and HDDCRAM_ST. The DDC RAMs are shared with MCU's XSRAM, configuration must be take care for reserving XSRAM for programming. For example, Set ADDCRAM_ST = 0x2, DDDCRAM_ST = 0x3, HDDCRAM_ST = 0x2 and disable , DDC2. The XSRAM for MCU is 512 bytes and ADC DDC is used with 256 bytes.

The DDC of RTD2662 is compliant with VESA DDC standard. All DDC slaves are in DDC1 mode after reset. When a high to low transition is detected on ASCL/DSCL/HSCL pin, the DDC slave will enter DDC2 transition mode. The DDC slave can revert to DDC1 mode if the SCL signal keeps unchanged for 128 VSYNC periods in DDC2 transition mode and RVT_A_DDC1_EN / RVT_D_DDC1_EN / RVT_H_DDC1_EN = 1. In DDC2 transition mode, the DDC slave will lock in DDC2 mode if a valid control byte is received. Furthermore, user can force the DDC slave to operate DDC2 mode by setting A_DDC2 / D_DDC2 / H_DDC2 = 1.

Register::ADC_DDC_enable				0xFF1B	
Name	Bits	R/W	Default	Comments	Config
A_DDC_ADDR	7:5	R/W	0	ADC DDC Channel Address Least Significant 3 Bits (The default DDC channel address MSB 4 Bits is "A")	
A_SCL_DBN_SEL	4	R/W	0	SCL Debounce Clock Selection 1: De-bounce reference clock	

				0: De-bounce clock (after clock divider)	
A_DDC_W_STA	3	R/W	0	ADC DDC Write Status (for external DDC access only) It is cleared after write. (No matter what the data are)	Rport wport
A_DDCRAM_W_EN	2	R/W	0	ADC DDC SRAM Write Enable (for external DDC access only) 0: Disable 1: Enable	
A_DBN_EN	1	R/W	1	ADC DDC De-bounce Enable 0: Disable 1: Enable (with crystal/4)	
A_DDC_EN	0	R/W	0	ADC DDC Channel Enable Bit 0: MCU access Enable 1: DDC channel Enable	

Register::ADC_DDC_control_1				0xFF1C	
Name	Bits	R/W	Default	Comments	Config
A_DBN_CLK_SEL	7:6	R/W	0	De-bounce clock divider 00: 1/1 reference clock 01: 1/2 reference clock 1X: 1/4 reference clock	
A_STOP_DBN_SEL	5:4	R/W	0	De-bounce sda stage 0X: latch one stage 10: latch two stage 11: latch three stage	
A_SYS_CK_SEL	3	R/W	0	De-bounce reference clock 0: crystal clock 1. Serial flash clock (M2PLL / Flash_DIV)	
A_DDC2	2	R/W	0	Force to ADC DDC to DDC2 mode 0: Normal operation 1: DDC2 is active	
RST_A_DDC	1	R/W	0	Reset ADC DDC circuit 0: Normal operation 1: reset (auto cleared)	Rport

					wport
RVT_A_DDC1_EN	0	R/W	0	ADC DDC revert to DDC1 enable(SCL idle for 128 VSYNC) 0: Disable 1: Enable	

Register::ADC_DDC_control_2						0xFF1D					
Name	Bits	R/W	Default	Comments		Config					
Reserved	7:1	-									
A_FORCE_SCL_L	0	R/W	0	Force external SCL bus low 1: Driving SCL = 0 after external SCL = 0 0: Release SCL							

Register::DDC2_enable						0xFF1E					
Name	Bits	R/W	Default	Comments		Config					
D_DDC_ADDR	7:5	R/W	0	DDC2 Channel Address Least Significant 3 Bits (The default DDC channel address MSB 4 Bits is "A")							
D_SCL_DBN_SEL	4	R/W	0	SCL Debounce Clock Selection 1: De-bounce reference clock 0: De-bounce clock (after clock divider)							
D_DDC_W_STA	3	R/W	0	DDC2 External Write Status (for external DDC access only) It is cleared after write.		Wport rport					
D_DDCRAM_W_EN	2	R/W	0	DDC2 External Write Enable (for external DDC access only) 0: Disable 1: Enable							
D_DBN_EN	1	R/W	1	DDC2 Debounce Enable 0: Disable 1: Enable (with crystal/4)							
D_DDC_EN	0	R/W	0	DDC2 Channel Enable Switch							

				0: MCU access Enable 1: External DDC access Enable	
--	--	--	--	---	--

Register::DDC2_control_1				0xFF1F	
Name	Bits	R/W	Default	Comments	Config
D_DBN_CLK_SEL	7:6	R/W	0	De-bounce clock divider 00: 1/1 reference clock 01: 1/2 reference clock 1X: 1/4 reference clock	
D_STOP_DBN_SEL	5:4	R/W	0	De-bounce sda stage 0X: latch one stage 10: latch two stage 11: latch three stage	
D_SYS_CK_SEL	3	R/W	0	De-bounce reference clock 0: crystal clock 1. Serial flash clock (M2PLL / Flash_DIV)	
D_DDC2	2	R/W	0	Force to DDC2 to DDC2 mode 0: Normal operation 1: DDC2 is active	
RST_D_DDC	1	R/W	0	Reset DDC2 circuit 0: Normal operation 1: reset (auto cleared)	Rport wport
RVT_D_DDC1_EN	0	R/W	0	DDC2 revert to DDC1 enable(SCL idle for 128 VSYNC) 0: Disable 1: Enable	

Register::DDC2_control_2				0xFF20	
Name	Bits	R/W	Default	Comments	Config
Reserved	7:1		-		
D_FORCE_SCL_L	0	R/W	0	Force external SCL bus low 1: Driving SCL = 0 after external SCL = 0 0: Release SCL	

Register::DDCRAM_partition				0xFF21	
Name	Bits	R/W	Default	Comments	Config
Reserved	7:6	-			
ADDCRAM_ST	5:4	R/W	0x3	ADDC RAM Start Address is 0xFC00 + ADDCRAM_ST*0x80, ADDCRAM SIZE = DDDCRAM_ST – ADDCRAM_ST	
DDDCRAM_ST	3:2	R/W	0x3	DDDC RAM Start Address is 0xFC80 + DDDCRAM_ST*0x80, DDDCRAM SIZE = HDDCRAM_ST – DDDCRAM_ST	
HDDCRAM_ST	1:0	R/W	0x3	HDDC RAM Start Address is 0xFD00 + ADDCRAM_ST*0x80, HDDCRAM SIZE = 0xFF00 – HDDCRAM_ST	

Register::VSYNC_Sel				0xFF22	
Name	Bits	R/W	Default	Comments	Config
Reserved	7:4	-			
VS_CON1	3:2	R/W	0	00: VSYNC1 signal is connected to ADC DDC 01: VSYNC1 signal is connected to DDC2 1x: VSYNC1 signal is connected to DDC3	
VS_CON2	1:0	R/W	0	00: VSYNC2 signal is connected to ADC DDC 01: VSYNC2 signal is connected to DDC2 1x: VSYNC2 signal is connected to DDC3	

DDC-CI

Register::IIC_set_slave				0xFF23	
Name	Bits	R/W	Default	Comments	Config
IIC_ADDR	7:1	R/W	37	IIC Slave Address to decode	
CH_SEL	0	R/W	0	Channel Select, overridden by HCH_SEL(0xFF2B[0]) = 1 0: from ADC DDC 1: from DDC2	

Register::IIC_sub_in				0xFF24	
Name	Bits	R/W	Default	Comments	Config
IIC_SUB_ADDR	7:0	R	00	IIC Sub-Address Received	

Register::IIC_data_in					0xFF25
Name	Bits	R/W	Default	Comments	Config
IIC_D_IN	7:0	R	00	IIC data received. 16-bytes depth read in buffer mode	RPORT

Register::IIC_data_out					0xFF26
Name	Bits	R/W	Default	Comments	Config
IIC_D_OUT	7:0	W	00	IIC data to be transmitted	Rport Wport

Register::IIC_status					0xFF27
Name	Bits	R/W	Default	Comments	Config
A_WR_I	7	R/W	0	If ADC DDC detects a STOP condition in write mode, this bit is set to "1". Write 0 to clear.	Rport Wport
D_WR_I	6	R/W	0	If DDC2 detects a STOP condition in write mode, this bit is set to "1". Write 0 to clear.	Rport Wport
DDC_128VS1_I	5	R/W	0	In DDC2 Transition mode, SCL idle for 128 VSYNC. Write 0 to clear.	Rport Wport
STOP_I	4	R/W	0	If IIC detects a STOP condition(slave address must match), this bit is set to "1". Write 0 to clear.	Rport Wport
D_OUT_I	3	R	0	If IIC_DATA_OUT loaded to serial-out-byte, this bit is set to "1". Write IIC_data_out (FF25) to clear.	
D_IN_I	2	R	0	If IIC_DATA_IN latched, this bit is set to "1". Read IIC_data_in (FF24) to clear.	
SUB_I	1	R/W	0	If IIC_SUB latched, this bit is set to "1" Write 0 to clear.	Rport Wport
SLV_I	0	R/W	0	If IIC_SLAVE latched, this bit is set to "1" Write 0 to clear.	Rport Wport

Register::IIC_IRQ_control				0xFF28	
Name	Bits	R/W	Default	Comments	Config
AWI_EN	7	R/W	0	0: Disable the A_WR_I signal as an interrupt source 1: Enable the A_WR_I signal as an interrupt source	
DWI_EN	6	R/W	0	0: Disable the D_WR_I signal as an interrupt source 1: Enable the D_WR_I signal as an interrupt source	
DDC_128VS11_EN	5	R/W	0	0: Disable the 128VS1_I signal as an interrupt source 1: Enable the 128VS1_I signal as an interrupt source	
STOPI_EN	4	R/W	0	0: Disable the STOP_I signal as an interrupt source 1: Enable the STOP_I signal as an interrupt source	
DOI_EN	3	R/W	0	0: Disable the D_OUT_I signal as an interrupt source 1: Enable the D_OUT_I signal as an interrupt source	
DII_EN	2	R/W	0	0: Disable the D_IN_I signal as an interrupt source 1: Enable the D_IN_I signal as an interrupt source	
SUBI_EN	1	R/W	0	0: Disable the SUB_I signal as an interrupt source 1: Enable the SUB_I signal as an interrupt source	
SLVI_EN	0	R/W	0	0: Disable the SLV_I signal as an interrupt source 1: Enable the SLV_I signal as an interrupt source	

Register::IIC_status2				0xFF29	
Name	Bits	R/W	Default	Comments	Config
IIC_FORCE_SCL_L	7	R/W	0	Force SCL = 0 when one of the following tow case happen: 1. IIC_BUF_FULL = 1 in write mode 2. IIC_BUF_EMPTY = 1 in read mode	
FORCE_NACK	6	R/W	0	Force IIC return NACK when one of the following tow case happen: IIC_BUF_FULL = 1 in write mode	
IIC_BUF_OV	5	R/W	0	IIC_DATA_BUFFER Overflow. Write '0' to clear	Rport Wport
IIC_BUF_UN	4	R/W	0	IIC_DATA_BUFFER Underflow. Write '0' to clear	Rport Wport
DDC_128VS2_I	3	R/W	0	In DDC2 Transition mode, SCL idle for 128 VSYNC. Write 0 to clear. Write '0' to clear	Rport

					Wport
IIC_BUF_FULL	2	R	0	IIC_DATA_BUFFER Full If IIC_DATA buffer is full, this bit is set to "1". (On-line monitor) The IIC_DATA buffer Full status will be on-line-monitor the condition, once it becomes full, it kept high, if it is not-full, then it goes low.	
IIC_BUF_EMPTY	1	R	0	IIC_DATA_BUFFER Empty If IIC_DATA buffer is empty, this bit is set to "1". (On-line monitor) The IIC_DATA buffer Empty status will be on-line-monitor the condition, once it becomes empty, it kept high, if it is not-empty, then it goes low.	
H_WR_I	0	R/W	0	If DDC3 detects a STOP condition in write mode, this bit is set to "1". Write 0 to clear.	rport Wport

Register::IIC_IRQ_control2				0xFF2A	
Name	Bits	R/W	Default	Comments	Config
AUTO_RST_BUF	7	R/W	0	Auto reset IIC_DATA Buffer 0: disable 1: enable In host (pc) write enable, when IIC write (No START after IIC_SUB), reset IIC_DATA buffer.	
RST_DATA_BUF	6	R/W	0	Reset IIC_DATA buffer 0: Finish 1: Reset	Wport Rport
DATA_BUF_WEN	5	R/W	0	IIC_DATA buffer write enable 0: host (pc) write enable 1: slave (mcu) write enable Both PC and MCU can read IIC_DATA buffer, but only one can write IIC_DATA buffer.	
Dummy_2	4	R/W	0	Reserved	
DDC_128VS2_I_EN	3	R/W	0	0: Disable the 128VS2_I signal as an interrupt source 1: Enable the 128VS2_I signal as an interrupt source	
DDC_BUF_FULL_EN	2	R/W	0	0: Disable the DDC_DATA_BUFFER Full signal as an	

				interrupt source 1: Enable the DDC_DATA_BUFFER Full signal as an interrupt source
DDC_BUF_EMPTY_EN	1	R/W	0	0: Disable the DDC_DATA_BUFFER Empty signal as an interrupt source 1: Enable the DDC_DATA_BUFFER Empty signal as an interrupt source
HWI_EN	0	R/W	0	0: Disable the H_WR_I signal as an interrupt source 1: Enable the H_WR_I signal as an interrupt source

Register::IIC_channel_control				0xFF2B	
Name	Bits	R/W	Default	Comments	Config
Reserved	7:2	--	0	Reserved	
RLS_SCL_SU	1	R/W	0	Set IIC data Setup Time When holding SCL low 0: Use Delay Chain (~5ns) 1: Use Crystal Clock to increase data setup time relative to SCL clock line	
HCH_SEL	0	R/W	0	Channel Select of DDC-CI 1: from DDC3 0: controlled by CH_SEL	

Register:: DDC3_enable				0xFF2C	
Name	Bits	R/W	Default	Comments	Config
H_DDC_ADDR	7:5	R/W	0	DDC3 Channel Address Least Significant 3 Bits (The default DDC channel address MSB 4 Bits is "A")	
D_SCL_DBN_SEL	4	R/W	0	SCL Debounce Clock Selection 1: De-bounce reference clock 0: De-bounce clock (after clock divider)	
H_DDC_W_STA	3	R/W	0	DDC3 Write Status (for external DDC access only) It is cleared after write.	Rport Wport
H_DDCRAM_W_EN	2	R/W	0	DDC3 SRAM Write Enable (for external DDC access only)	

				0: Disable 1: Enable	
H_DBN_EN	1	R/W	1	DDC3 De-bounce Enable 0: Disable 1: Enable (with crystal/4)	
H_DDC_EN	0	R/W	0	DDC3 Channel Enable Bit 0: MCU access Enable 1: DDC channel Enable	

Register:: DDC3_control_1						0xFF2D	
Name	Bits	R/W	Default	Comments	Config		
H_DBN_CLK_SEL	7:6	R/W	0	De-bounce clock divider 00: 1/1 reference clock 01: 1/2 reference clock 1X: 1/4 reference clock			
H_STOP_DBN_SEL	5:4	R/W	0	De-bounce sda stage 0X: latch one stage 10: latch two stage 11: latch three stage			
H_SYS_CK_SEL	3	R/W	0	De-bounce reference clock 0: crystal clock 1: Serial flash clock (M2PLL / Flash_DIV)			
H_DDC2	2	R/W	0	Force to DDC3 to DDC2 mode 0: Normal operation 1: DDC2 is active			
RST_H_DDC	1	R/W	0	Reset DDC3 circuit 0: Normal operation 1: reset (auto cleared)	Rport	Wport	
RVT_H_DDC1_EN	0	R/W	0	DDC3 revert to DDC1 enable(SCL idle for 128 VSYNC) 0: Disable 1: Enable			

Register::DDC3_control_2						0xFF2E	
--------------------------	--	--	--	--	--	--------	--

Name	Bits	R/W	Default	Comments	Config
Dummy_3	7:1	R/W	0		
H_FORCE_SCL_L	0	R/W	0	Force external SCL bus low 1: Driving SCL = 0 after external SCL = 0 0: Release SCL	

The access ports below are used for external host interface only.

Register::ADC_DDC_INDEX 0XFF2F					
Name	Bits	R/W	Default	Comments	Config
A_DDC_INDEX	7:0	R/W	0	DDC SRAM Read/Write Index Register [7:0]	Rport Wport

Register::ADC_DDC_ACCESS_PORT 0XFF30					
Name	Bits	R/W	Default	Comments	Config
A_DDC_ACCESS_PORT	7:0	R/W	0	DDC SRAM Read/Write Port	Rport Wport

Register::DDC2_INDEX 0XFF31					
Name	Bits	R/W	Default	Comments	Config
D_DDC_INDEX	7:0	R/W	0	DDC SRAM Read/Write Index Register [7:0]	Rport Wport

Register::DDC2_ACCESS_PORT 0XFF32					
Name	Bits	R/W	Default	Comments	Config
D_DDC_ACCESS_PORT	7:0	R/W	0	DDC SRAM Read/Write Port	Rport Wport

Register::DDC3_INDEX 0XFF33					
Name	Bits	R/W	Default	Comments	Config
H_DDC_INDEX	7:0	R/W	0	DDC SRAM Read/Write Index Register [7:0]	Rport Wport

Register::DDC3_ACCESS_PORT 0XFF34					
Name	Bits	R/W	Default	Comments	Config
H_DDC_ACCESS_PORT	7:0	R/W	0	DDC SRAM Read/Write Port	Rport

						Wport
--	--	--	--	--	--	-------

PWM

RTD2662 supports 6 channels of PWM DAC. The resolution of each PWM is 12-bit. PWM0, PWM1, PWM2, PWM3, PWM4 and PWM5 are connected to DA0, DA1, DA2, DA3, DA4 and DA5 respectively. The figure below represents the PWM clock generator. Based on the clock, we make up the PWM waveform which frequency is $1/4096$ of the PWM clock.

The PWM duty registers have 12-bit resolution. These registers have double buffer mechanism. When write the MSB bit, the 12-bit data will be loaded.

The PWM frequency is :

$$f_{pwm} = f_{clk} / 2^M / (N+1) / 4096$$

The PWM frequency range is :

$$f_{clk} = 27M, f_{pwm} = 6.6KHz \sim 0.2Hz$$

$$f_{clk} = 243M, f_{pwm} = 60KHz \sim 1.8Hz$$

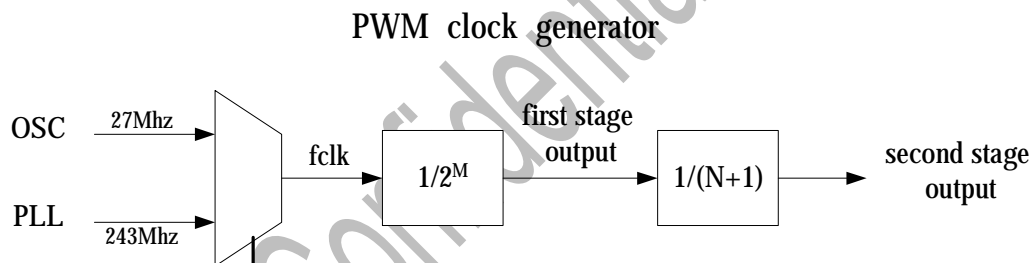

Register::PWM_CK_SEL				0xFF3A	
Name	Bits	R/W	Default	Comments	Config
PWM_CK_SEL_DUMMY	7:6	R/W	0	dummy	
PWM5_CK_SEL	5	R/W	0	PWMx clock generator input source 0: Crystal 1: PLL output	
PWM4_CK_SEL	4	R/W	0	PWMx clock generator input source 0: Crystal 1: PLL output	
PWM3_CK_SEL	3	R/W	0	PWMx clock generator input source 0: Crystal 1: PLL output	

PWM2_CK_SEL	2	R/W	0	PWMx clock generator input source 0: Crystal 1: PLL output	
PWM1_CK_SEL	1	R/W	0	PWMx clock generator input source 0: Crystal 1: PLL output	
PWM0_CK_SEL	0	R/W	0	PWMx clock generator input source 0: Crystal 1: PLL output	

Register::PWM03_M						0xFF3B
Name	Bits	R/W	Default	Comments	Config	
PWM3_M	7:6	R/W	0	PWMx clock first stage divider		
PWM2_M	5:4	R/W	0	PWMx clock first stage divider		
PWM1_M	3:2	R/W	0	PWMx clock first stage divider		
PWM0_M	1:0	R/W	0	PWMx clock first stage divider		

Register::PWM45_M						0xFF3C
Name	Bits	R/W	Default	Comments	Config	
PWM_M_DUMMY	7:4	R/W	0	dummy		
PWM5_M	3:2	R/W	0	PWMx clock first stage divider		
PWM4_M	1:0	R/W	0	PWMx clock first stage divider		

Register::PWM01_N_MSB						0xFF3D
Name	Bits	R/W	Default	Comments	Config	
PWM1H_N	7:4	R/W	0	PWMx clock Second stage divider MSB[11:8]		
PWM0H_N	3:0	R/W	0	PWMx clock Second stage divider MSB[11:8]		

Register::PWM0_N_LSB						0xFF3E
Name	Bits	R/W	Default	Comments	Config	

PWM0L_N	7:0	R/W	0	PWMx clock Second stage divider LSB[7:0]	
---------	-----	-----	---	--	--

Register::PWM1_N_LSB 0xFF3F					
Name	Bits	R/W	Default	Comments	Config
PWM1L_N	7:0	R/W	0	PWMx clock Second stage divider LSB[7:0]	

Register::PWM23_N_MSB 0xFF40					
Name	Bits	R/W	Default	Comments	Config
PWM3H_N	7:4	R/W	0	PWMx clock Second stage divider MSB[11:8]	
PWM2H_N	3:0	R/W	0	PWMx clock Second stage divider MSB[11:8]	

Register::PWM2_N_LSB 0xFF41					
Name	Bits	R/W	Default	Comments	Config
PWM2L_N	7:0	R/W	0	PWMx clock Second stage divider LSB[7:0]	

Register::PWM3_N_LSB 0xFF42					
Name	Bits	R/W	Default	Comments	Config
PWM3L_N	7:0	R/W	0	PWMx clock Second stage divider LSB[7:0]	

Register::PWM45_N_MSB 0xFF43					
Name	Bits	R/W	Default	Comments	Config
PWM4H_N	7:4	R/W	0	PWMx clock Second stage divider MSB[11:8]	
PWM5H_N	3:0	R/W	0	PWMx clock Second stage divider MSB[11:8]	

Register::PWM4_N_LSB 0xFF44					
Name	Bits	R/W	Default	Comments	Config
PWM4L_N	7:0	R/W	0	PWMx clock Second stage divider LSB[7:0]	

Register::PWM5_N_LSB 0xFF45					
--	--	--	--	--	--

Name	Bits	R/W	Default	Comments	Config
PWM5L_N	7:0	R/W	0	PWMx clock Second stage divider LSB[7:0]	

Register::PWML					0xFF46
Name	Bits	R/W	Default	Comments	Config
PWM_W_DB_WR	7	R/W	0	Write 1 to Set PWM_Width if PWM_W_DB_EN = 1'b1. Auto-Clear after PWM_Width was loaded	RPORT WPORT
PWM_W_DB_MODE	6	R/W	0	PWM Width Setting Double-Buffer Mode 0: Setting active after PWM_W_DB_WR = 1 1: Setting active after PWM_W_DB_WR = 1 & DVS.	
PWM5L	5	R/W	0	0: enable Active H 1: enable Active L	
PWM4L	4	R/W	0	0: enable Active H 1: enable Active L	
PWM3L	3	R/W	0	0: enable Active H 1: enable Active L	
PWM2L	2	R/W	0	0: enable Active H 1: enable Active L	
PWM1L	1	R/W	0	0: enable Active H 1: enable Active L	
PWM0L	0	R/W	0	0: enable Active H 1: enable Active L	

Register::PWM_VS_CTRL					0xFF47
Name	Bits	R/W	Default	Comments	Config
PWM_VS_CTRL_DUM	7:6	R/W	0	dummy	
PWM5_VS_RST_EN	5	R/W	0	0: Disable 1: Enable PWM5 reset by DVS	
PWM4_VS_RST_EN	4	R/W	0	0: Disable 1: Enable PWM4 reset by DVS	
PWM3_VS_RST_EN	3	R/W	0	0: Disable 1: Enable PWM3 reset by DVS	
PWM2_VS_RST_EN	2	R/W	0	0: Disable 1: Enable PWM2 reset by DVS	
PWM1_VS_RST_EN	1	R/W	0	0: Disable 1: Enable PWM1 reset by DVS	
PWM0_VS_RST_EN	0	R/W	0	0: Disable 1: Enable PWM0 reset by DVS	

Register::PWM_EN				0xFF48	
Name	Bits	R/W	Default	Comments	Config
PWM_W_DB_EN	7	R/W	0	0: PWM Width set when write MSB 1: PWM Width setting double-buffered enable	
PWM_WIDTH_SEL	6	R/W	0	0: PWMxL_DUT is active 1: PWMxL_DUT is inactive, forced to 4'h0 internally	
PWM5_EN	5	R/W	0	0: PWM output disable 1: PWM output enable	
PWM4_EN	4	R/W	0	0: PWM output disable 1: PWM output enable	
PWM3_EN	3	R/W	0	0: PWM output disable 1: PWM output enable	
PWM2_EN	2	R/W	0	0: PWM output disable 1: PWM output enable	
PWM1_EN	1	R/W	0	0: PWM output disable 1: PWM output enable	
PWM0_EN	0	R/W	0	0: PWM output disable 1: PWM output enable	

Register::PWM_CK				0xFF49	
Name	Bits	R/W	Default	Comments	Config
PWM_CK_DUMMY	7:6	R/W	0	Dummy	
PWM5_CK	5	R/W	0	0: Select first stage output 1: Select second stage output	
PWM4_CK	4	R/W	0	0: Select first stage output 1: Select second stage output	
PWM3_CK	3	R/W	0	0: Select first stage output 1: Select second stage output	
PWM2_CK	2	R/W	0	0: Select first stage output 1: Select second stage output	
PWM1_CK	1	R/W	0	0: Select first stage output 1: Select second stage output	
PWM0_CK	0	R/W	0	0: Select first stage output 1: Select second stage output	

Register::PWM0H_DUT				0xFF4A	
Name	Bits	R/W	Default	Comments	Config
PWM0H_DUT	7:0	R/W	0	PWM0[11:4] duty width When write the MSB bit (PWM_W_DB_EN=0), the 12-bit data will be loaded.	RPORT WPORT

Register::PWM1H_DUT 0xFF4B					
Name	Bits	R/W	Default	Comments	Config
PWM1H_DUT	7:0	R/W	0	PWM1[11:4] duty width When write the MSB bit (PWM_W_DB_EN=0) , the 12-bit data will be loaded.	RPORT WPORT

Register::PWM01L_DUT 0xFF4C					
Name	Bits	R/W	Default	Comments	Config
PWM1L_DUT	7:4	R/W	0	PWM1[3:0] duty width	RPORT WPORT
PWM0L_DUT	3:0	R/W	0	PWM0[3:0] duty width	RPORT WPORT

Register::PWM2H_DUT 0xFF4D					
Name	Bits	R/W	Default	Comments	Config
PWM2H_DUT	7:0	R/W	0	PWM2[11:4] duty width When write the MSB bit (PWM_W_DB_EN=0) , the 12-bit data will be loaded.	RPORT WPORT

Register::PWM3H_DUT 0xFF4E					
Name	Bits	R/W	Default	Comments	Config
PWM3H_DUT	7:0	R/W	0	PWM3[11:4] duty width When write the MSB bit (PWM_W_DB_EN=0) , the 12-bit data will be loaded.	RPORT WPORT

Register::PWM23L_DUT 0xFF4F					
Name	Bits	R/W	Default	Comments	Config
PWM3L_DUT	7:4	R/W	0	PWM3[3:0] duty width	RPORT WPORT
PWM2L_DUT	3:0	R/W	0	PWM2[3:0] duty width	RPORT WPORT

Register::PWM4H_DUT 0xFF50					
Name	Bits	R/W	Default	Comments	Config
PWM4H_DUT	7:0	R/W	0	PWM4[11:4] duty width When write the MSB bit (PWM_W_DB_EN=0) , the 12-bit data will be loaded.	RPORT WPORT

Register::PWM5H_DUT 0xFF51					
Name	Bits	R/W	Default	Comments	Config
PWM5H_DUT	7:0	R/W	0	PWM5[11:4] duty width When write the MSB bit (PWM_W_DB_EN=0) , the 12-bit data will be loaded.	RPORT WPORT

Register::PWM45L_DUT 0xFF52					
Name	Bits	R/W	Default	Comments	Config
PWM5L_DUT	7:4	R/W	0	PWM5[3:0] duty width	RPORT WPORT
PWM4L_DUT	3:0	R/W	0	PWM4[3:0] duty width	RPORT WPORT

Register:: REV_DUMMY3 0xFF53					
Name	Bits	R/W	Default	Comments	Config
REV_DUMMY3	7:0	R/W	00	Dummy3	

I2C Control Module

RTD2662 provides one I2C master interface only.

Master

In the Random read operation, the slave address and data are clocked in and acknowledged by the slave. The master will generate another start condition. In Current address read operation, the internal data word address counter maintains the data word address accessed during the last read or write operation, incremented by one. The data word address stays valid between operations as long as the power is maintained. A Write operation requires data words following the slave address word

and acknowledgment. The master terminates the write sequence with a stop condition. In Write with restart operation, master will generate another start condition after transmitting the slave address and data. If slave needs stop condition between data and restart command (Sr) in the Random read operation, software can transmit the Current address read operation following A Write operation. The maximum value of data FIFO (N) is 24. The slave address byte will be written into FIFO register together with data. Software must write the eighth bit of slave address byte to decide the access is read or write.

NOTE:

- (a) RTD2660 only supports master function
- (b) RTD2660 doesn't support arbitration mechanism while one system exists over 2 masters
- (c) FIFO can't support R/W at the same time. It means that you can't transmit data successively while the byte counts over 24, since MCU have to refresh the FIFO data for the next transmit
- (d) Master supports the function that slave can hold SCL to zero after ACK when slave can't give master data that master wanted.

Signal Name	Type	Function	Note
SCL	O		
SDA	I/O		

Register:: I2CM_CR0				0xFF55	
Name	Bits	R/W	Default	Comments	Config
IIC_SW_RSTN	7	R/W	0	IIC master software reset 0: Reset, Blocking IICM module 1: Enable IICM module	
CS	6	R/W	0	Command Start 0 = Stop, after completing whole transaction, it returns to zero 1 = Start	wport rport
RWL	5:1	R/W	0	Read/Write data Length for related commands. Not includes slave address byte in FIFO register. When access, controller will parse the byte followed last start (or Sr) byte to know the command type. 0x00 = 1 bytes :	

				0x17 = 24 bytes	
TOR	0	R/W	1	TOR enable If TOR is desired, I2C rate must be constrained form 25kb/s~ 400kb/s. This constraint is due to the time-out register bit.	

Register:: I2CM_CR1				0xFF56	
Name	Bits	R/W	Default	Comments	Config
TOR	7:0	R/W	0x3A	Time-out register Time-out = TOR x 2 x ((FD10+1)/input clock) (For receive /transmit one bit) If time-out occur, it will trigger Transaction Error Interrupt Flag Note: time-out must > (1 SCL low period + repeat start setup time)	

Register:: I2CM_CR2				0xFF57	
Name	Bits	R/W	Default	Comments	Config
reserved	7	-	0	Reserved to 0	
BURST	6	R/W	0	Burst mode enabled to write over 24 bytes to slave devices. While burst is enabled, whole I2C will be halted to let MCU write another more bytes to FIFO. After the job done, we have to set I2CM_SR to be high to continue the I2C write job	
SBAIFD	5	R/W	0	Reserved	
FBAIFD	4	R/W	0	Reserved	
SRSIB	3:2	R/W	0	Reserved	
FRSIB	1:0	R/W	0	Reserved	

Register:: I2CM_CR3				0xFF58	
Name	Bits	R/W	Default	Comments	Config
reserved	7:5	-	0	Reserved to 0	
RSC	4:3	R/W	0	Repeat start count 00: No repeat start 01: one repeat start 10: two repeat start	

				11: forbidden	
TEIE	2	R/W	0	Transaction Error Interrupt Enable	
MRCIE	1	R/W	0	Master Receive complete Interrupt Enable	
MTCIE	0	R/W	0	This Interrupt enable bit serve two conditions, one is “Master Transmit complete Interrupt Enable in single mode” and the other is “Master Transmit partial Done Interrupt Enable in burst mode”	

Register:: I2CM_STR0				0xFF59	
Name	Bits	R/W	Default	Comments	Config
reserved	7	-	0	Reserved to 0	
I2CMD	6:4	R/W	0	I2C master debounce 0: sample rate=(input clk / (FD10+1)) 1: sample rate=(input clk / (FD10+1)) / 2 : 7: sample rate= (input clk / (FD10+1)) / 8	
FTPC	3:0	R/W	0x3	Fall time period count If the value of (Bus clock/FD10) does not approximate 10Mhz, FTPC can make sure that fall time of SCL is more than 300ns.	

Register:: I2CM_STR1				0xFF5A	
Name	Bits	R/W	Default	Comments	Config
STA_SUGPIO_C	7:0	R/W	0x09	STA setup time period count In repeat start, the setup time of SCL must match the I2C spec.	

Register:: I2CM_STR2				0xFF5B	
Name	Bits	R/W	Default	Comments	Config
SHPC	7:0	R/W	0x09	SCL high period counter (SCL High period=100ns*SHPC) SHPC must include rising time in the I2C spec.	

Register:: I2CM_STR3				0xFF5C	
----------------------	--	--	--	--------	--

Name	Bits	R/W	Default	Comments	Config
SLPC	7:0	R/W	0x10	SCL low period counter (SCL low period=100ns*SLPC) SLPC must include falling time in the I2C spec.	

Register:: I2CM_SR				0xFF5D	
---------------------------	--	--	--	---------------	--

Name	Bits	R/W	Default	Comments	Config
reserved	7:5	-	0	Reserved to 0	
BSA	4	R/W	0	Send again Control bit in burst mode 1: Send 0: Not action Write "1" to clear	wport rport
BMPIF	3	R/W	0	Burst Mode Pending Interrupt Flag While setting as burst mode and I2C master transmit data in TDD, this flag is asserted. Write "1" to clear	wport rport
TEIF	2	R/W	0	Transaction Error Interrupt Flag When master transmit/receive fault or time-out occurrence, I2C controller will lift the flag up and return to bus idle. Write "1" to clear	wport rport
MRCIF	1	R/W	0	Master Receive complete Interrupt flag Write "1" to clear	wport rport
MTCIF	0	R/W	0	This Interrupt enable bit serves two conditions, one is "Master Transmit complete Interrupt Enable in single mode" and the other is "Master Transmit partial Done Interrupt Enable in burst mode" Write "1" to clear	wport rport

Register:: I2CM_TD				0xFF5E	
---------------------------	--	--	--	---------------	--

Name	Bits	R/W	Default	Comments	Config
TDD	7:0	R/W	0	Target Device Data to receive or transmit	wport rport

Register:: I2CM_CCR				0xFF5F	
----------------------------	--	--	--	---------------	--

Name	Bits	R/W	Default	Comments	Config
reserved	7:6	-	0	Reserved to 0	
FD10	5:0	R/W	0x03	Frequency 10M Divisor 0 are forbidden 10M=input clock/(FD10+1) When power on, software must write FD10 to let I2C controller generate ~10 Mhz clock.	

MCU register 2(page E)
SPI-FLASH
Common Instruction Register

Register::common_inst_en						0xFF60
Name	Bits	R/W	Default	Comments	Config	
com_inst	7:5	R/W	0x0	000: no operation 001 : write 010 : Read 011 : write after WREN 100 : write after EWSR 101 : Erase		
write_num	4:3	R/W	0x0	Common instruction write number		
rd_num	2:1	R/W	0x0	Common instruction read number		
com_inst_en	0	R/W	0x0	Common instruction enable (auto clear when finish)	Wport Rport	

Register::common_op_code						0xFF61
Name	Bits	R/W	Default	Comments	Config	
com_op	7:0	R/W	0x0	Common instruction op code		

Register::wren_op_code						0xFF62
Name	Bits	R/W	Default	Comments	Config	
wren_op	7:0	R/W	0x06	Write enable op code		

Register::ewsr_op_code						0xFF63
Name	Bits	R/W	Default	Comments	Config	

ewsr_op	7:0	R/W	0x50	Enable write register op code	
---------	-----	-----	------	-------------------------------	--

Register::Flash_prog_ISP0 0xFF64					
Name	Bits	R/W	Default	Comments	Config
prog_h	7:0	R/W	0x00	Flash program/write/dummy/read CRC high byte[23:16]	Wport Rport

Register::Flash_prog_ISP1 0xFF65					
Name	Bits	R/W	Default	Comments	Config
prog_m	7:0	R/W	0x00	Flash program/write/dummy/read CRC middle byte[15:8]	Wport Rport

Register::Flash_prog_ISP2 0xFF66					
Name	Bits	R/W	Default	Comments	Config
prog_l	7:0	R/W	0x00	Flash program/write/dummy/read CRC low byte[7:0]	Wport Rport

Register::common_inst_read_port0 0xFF67					
Name	Bits	R/W	Default	Comments	Config
com_rd_h	7:0	R	0x00	Common instruction read high byte[23:16]	

Register::common_inst_read_port1 0xFF68					
Name	Bits	R/W	Default	Comments	Config
com_rd_m	7:0	R	0x00	Common instruction read middle byte[15:8]	

Register::common_inst_read_port2 0xFF69					
Name	Bits	R/W	Default	Comments	Config
com_rd_l	7:0	R	0x00	Common instruction read low byte[7:0]	

Common Instruction Usage :

1. Set common instruction type.
2. Set common instruction OP code.
3. Set write number (0 ~ 3).
4. Set read number if common instruction type is read.
5. Write data to **Flash_prog_write_dum_readCRC_ISP** if write number > 0 .
6. Execution common instruction enable.
7. Polling common instruction enable in ISP mode \Rightarrow If it is finished and the instruction is read, read the Data in **common_inst_read_port** .
8. It would auto clear in normal mode. Then read the Data in **common_inst_read_port** if the instruction type is read.

Common Instruction Setting Example :

Write function

	com_op	write_num=0			rd_num =0		
WREN	06h						
WRDI	04h						
EWSR	50h						
DP	B9h						
RDP	ABh						

Read function

write_num =0 , rd_num=3

	com_op	rd_num setting					
RDID	9Fh	ID23-ID16	ID15-ID8	ID7-ID0			
JEDEC ID READ*1	9Fh	ID2	ID1	Device ID			

write_num=0, rd_num=1

RDCR	A1h	RD_CR					
RDSR	05h	RD_SR					

write_num=3, rd_num=1 or 2

RES	ABh	DUMMY	DUMMY	DUMMY	Electronic Signature		
REMS	90h	DUMMY	DUMMY	00h	ID	Device ID	

Write after WREN function

	com_op	write_num=1	rd_num=0				
WRSR	01h	WR_SR					

Write after WRSR function

	com_op	write_num=1	rd_num=0				
WR_CR	F1h	WR_CR					

Erase function

	com_op	write_num = 0 or 3			rd_num=0		
SECTOR_ER (4k byte)	20h	AD1	AD2	AD3			
BLOCK_ER (64k byte)	D8h	AD1	AD2	AD3			
Page Erase	DBh	AD1	AD2	AD3			
CHIP_ER	C7h						

Realtek Confidential for GM Only

Program/Read/ISP/CRC Register

Register::read_op_code 0xFF6A					
Name	Bits	R/W	Default	Comments	Config
read_op	7:0	R/W	0x03	Read command op code	Wen_out

Note : 1 It would force flash controller to idle state when write this byte.

Register::fast_read_op_code 0xFF6B					
Name	Bits	R/W	Default	Comments	Config
Fast_read_op	7:0	R/W	0x0B	Fast read command op code	Wen_out

Note : 1 It would force flash controller to idle state when write this byte.

Register::read_instruction 0xFF6C					
Name	Bits	R/W	Default	Comments	Config
read_mode	7:6	R/W	0x0	00: normal read 01: fast read 10: fast dual data read	Wen_out
latch_so_rise	5	R/W	0x0	0: latch Flash SO Data in rising edge 1: latch Flash SO Data in falling edge	Wen_out
drive_si_fall	4	R/W	0x0	0: Output Flash SI Data in falling edge 1: Output Flash SI Data in rising edge	Wen_out
si_dly_sel	3:2	R/W	0x0	00: 0ns 01: 2ns 10: 4ns 11: 6ns	Wen_out
so_dly_sel	1:0	R/W	0x0	00: 0ns 01: 2ns 10: 4ns 11: 6ns	Wen_out

Note: 1. Normally, SPI Flash drive data in falling edge and sample data in rising edge !!!!

2. It would force flash controller to idle state when write this byte.

Register::program_op_code 0xFF6D					
Name	Bits	R/W	Default	Comments	Config
prog_op	7:0	R/W	0x02	Program command op code	

Register::read_status_register_op_code 0xFF6E					
---	--	--	--	--	--

Name	Bits	R/W	Default	Comments	Config
rdsr_op	7:0	R/W	0x05	Read status register register command op code	

Register::program_instruction 0xFF6F					
Name	Bits	R/W	Default	Comments	Config
isp_en	7	R/W	0x0	Enable ISP program : all registers except this register can't write/read when ISP_ENABLE=0 0: disable 1: enable (gating 8051 clock)	Rport Wport
prog_mode	6	R/W	0x0	0: normal mode 1: AAI mode	
prog_en	5	R/W	0x0	0: finish 1: program on-going (write 1 to start, auto clear when finish)	Rport Wport
prog_buf_wr_en	4	R	0x1	0: can't write data to sram 1: can write data to sram	
prog_dummy	3	R/W	0x0		
crc_start	2	R/W	0x0	When write one, read data from PROG_ST_ADDR to PROG_END_ADDR. And at the same time the CRC is calculated by IC automatically. This bit will be auto cleared when crc_done is 1.(Can be trigger in ISP Mode only)	Rport Wport
crc_done	1	R	0x1	It will show 1 when CRC is done, and will return to 0 when CRC_START is set.	
rst_flash_ctrl	0	R/W	0x0	0: disable 1: software reset flash controller	Rport Wport

No Use Parser::program_data_port 0xFF70					
Name	Bits	R/W	Default	Comments	Config
prog_port	7:0	W		Program write data port to SRAM	

Register::program_length						0xFF71
Name	Bits	R/W	Default	Comments	Config	
prog_length	7:0	R/W	0xFF	Program write number		

Register::CRC_end_addr0						0xFF72
Name	Bits	R/W	Default	Comments	Config	
rdcrc_end_addr_h	7:0	R/W	0x00	Read CRC end address high byte [23:16]		

Register::CRC_end_addr1						0xFF73
Name	Bits	R/W	Default	Comments	Config	
rdcrc_end_addr_m	7:0	R/W	0x00	Read CRC end address middle byte [15:8]		

Register::CRC_end_addr2						0xFF74
Name	Bits	R/W	Default	Comments	Config	
rdcrc_end_addr_l	7:0	R/W	0x00	Read CRC end address low byte [7:0]		

Register::CRC_result						0xFF75
Name	Bits	R/W	Default	Comments	Config	
crc_result	7:0	R	-	CRC value of data between PROG_ST_ADDR and RDCRC_END_ADDR		

Flash timing Register

Register::cen_ctrl						0xFF76
Name	Bits	R/W	Default	Comments	Config	
cen_high_num	7:4	R/W	0x9	Chip enable high number[3:0] (based on flash clock) Cycle : 1 ~ 16 (0x0 ~ 0xF)	Wen_out	

cen_setup_num	3:2	R/W	0x0	Chip enable setup number (based on flash clock) Cycle : 0.5 ~ 3.5 Cycle : 1 ~ 4 (if drive_si_fall)	Wen_out
cen_hold_num	1:0	R/W	0x0	Chip enable hold number (based on flash clock) Cycle : 1 ~ 4 Cycle : 0.5 ~ 3.5 (if drive_si_fall)	Wen_out

Note : 1 It would force flash controller to idle state when write this byte.

IrDA

IR Control

Infrared remote control module is designed for receiving infrared command from consumer remote controller, This module receives signal from external infrared demodulator, translates signal zeros and ones into data zeros and ones, accumulates data bits which confirm to the requirements of settings in the register, buffers and transmitted data. The figures are the original signal that remote controller emits.

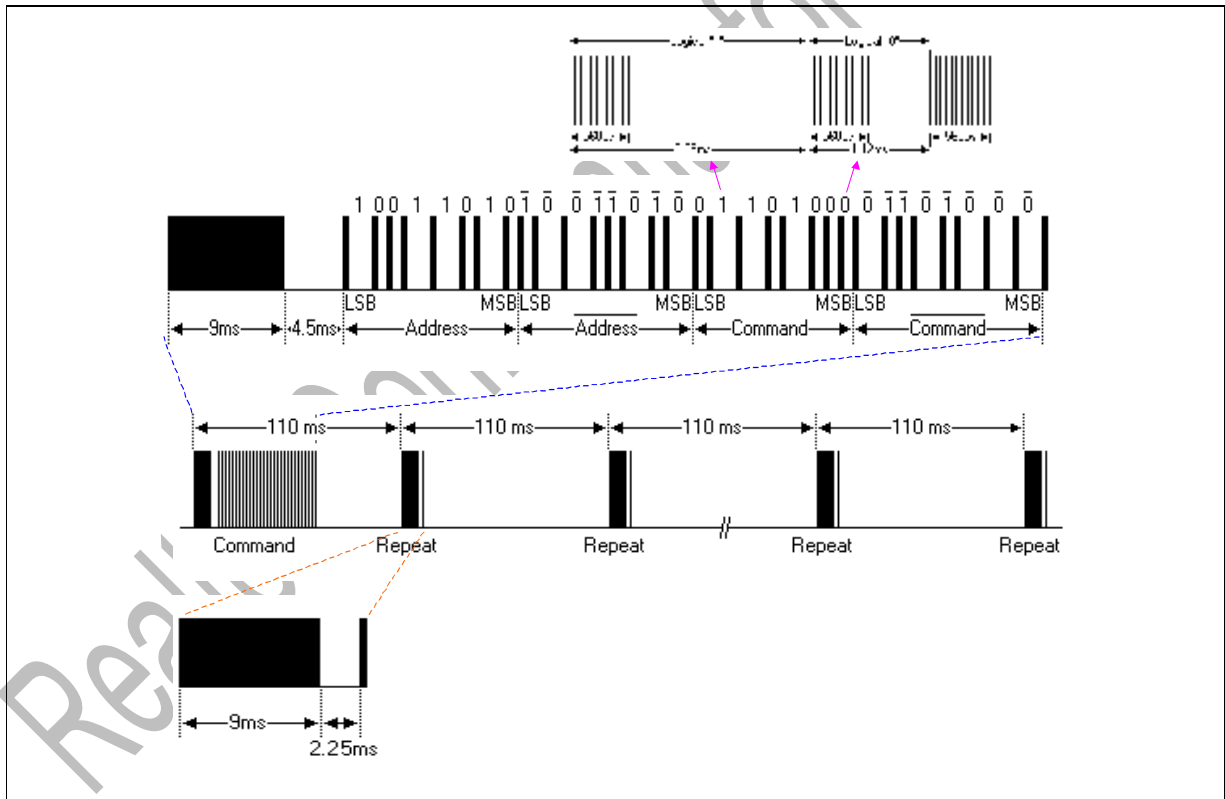

NEC line coding and modulation method (length coding method)

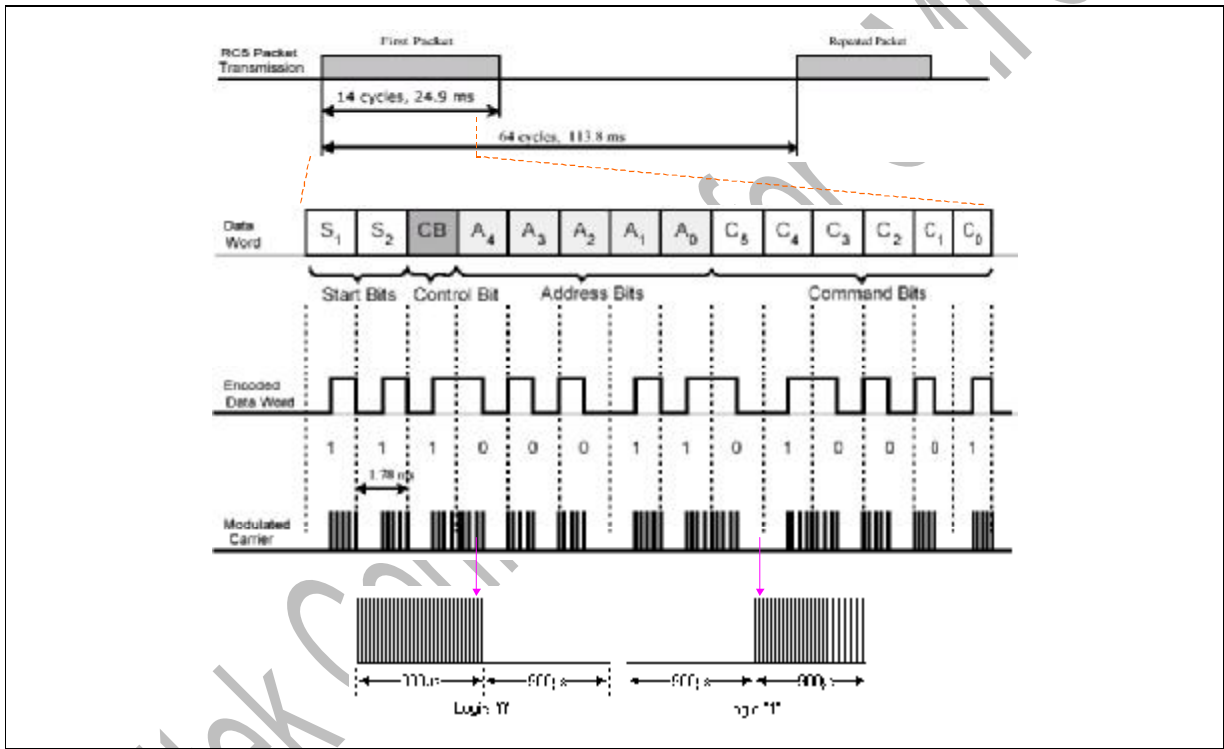

RC-5 line coding and modulation method (phase coding method)

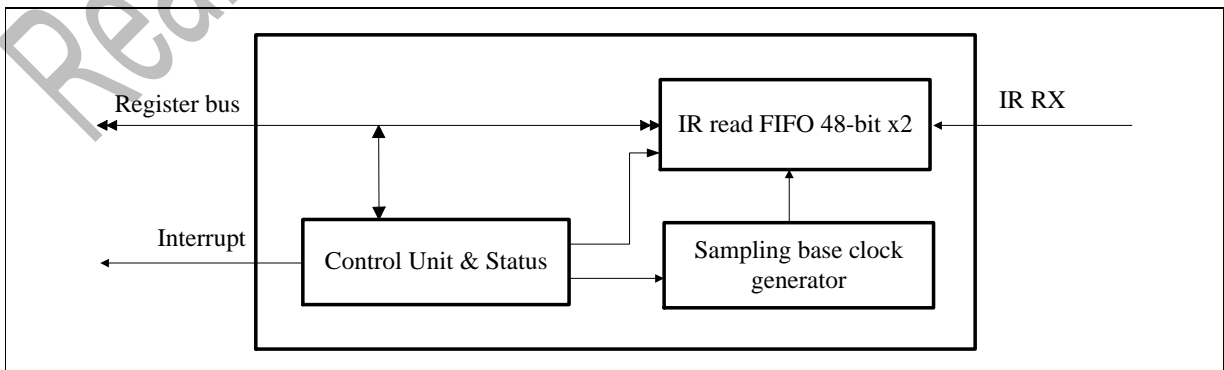

Infrared control functional block diagram

RTD2662 provides a universal Infrared decoder that decodes mostly infrared coding method via programmable parameter set. Infrared decoder uses a programmable sampling clock generator to fit the infrared speed. The two layer 48-bit FIFO stores the infrared data. And an interrupt signal interrupts CPU when infrared data received.

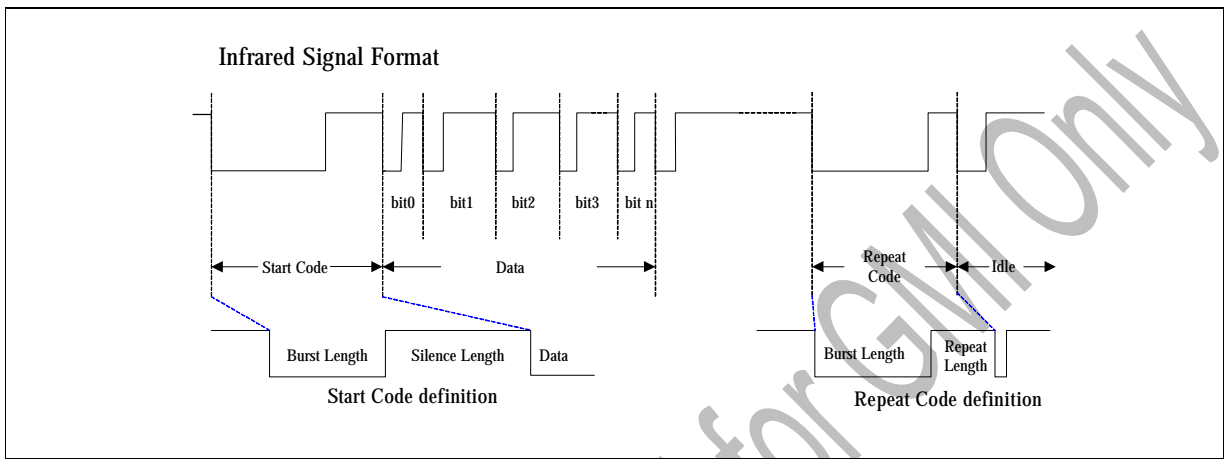

Infrared signal format definition

AS shown in the above figure, burst length and silence length define the start code, burst length and repeat length define the repeat code, data bit n defines the total valid bit number. And as show in the following figure, the modulation length, data one length and data zero length define the bit data format.

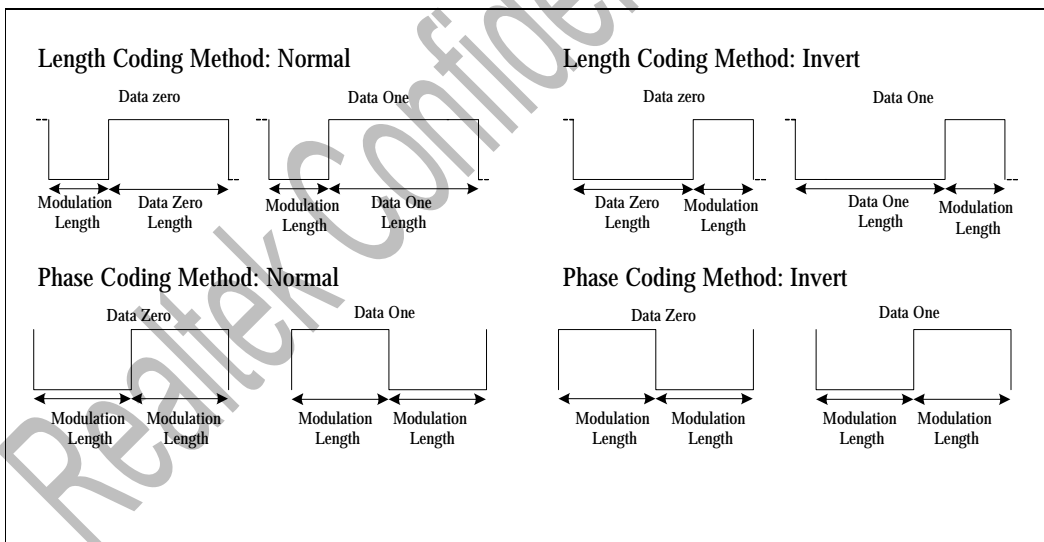

Infrared signal data bit definition

Register:: IR_Ctr1				0xFF80		
Name	Bits	R/W	Default	Comments		Config
sd_d_d_sd	7	R/W	0	Dummy		

start_code	6	R/W	1	Start Code enable 0: disable, infrared decoder does not detect the start code 1: enable, infrared decoder must detect the start code leading the data bits. This is used for NEC and Sony SIRC.
repeat_code	5	R/W	0	Repeat Code 0: no repeat code exit 1: repeat code
reserved	4:3	-	0	Reserved to 0
irin_inv	2	R/W	0	Input Inversion 0: normal 1: Invert Infrared decoder only can decodes the infrared signal that acting from high to low transition. As setting this to '1', the signal from "external Infrared demodulator" will be inverted, then being decoded by this infrared decoder. This is used for decoding "Sony SIRC" protocol
reserved	1:0	-	0	Reserved to 0

Register:: IR_debounce				0xFF81	
Name	Bits	R/W	Default	Comments	Config
rclk_sel	7:6	R/W	0	Remote Control Clock-Rate (Work only when IR_Status[1]=0) Crystal = 27 MHZ 0: IRSamplingCLK = crystal/512 1: IRSamplingCLK = crystal/128 2: IRSamplingCLK = crystal/256 3: IRSamplingCLK = crystal/1024 IRSamplingCLK is used to sampling the signal that from "external infrared demodulator".	
denos_num	5:0	R/W	0x0A	Remote Debounce(De-noise number) Number (value+1) of IRSamplingCLK De-Bounce circuit is included in infrared decoder module hat defines the debounce length that refer to the following figure for detail illustration.	

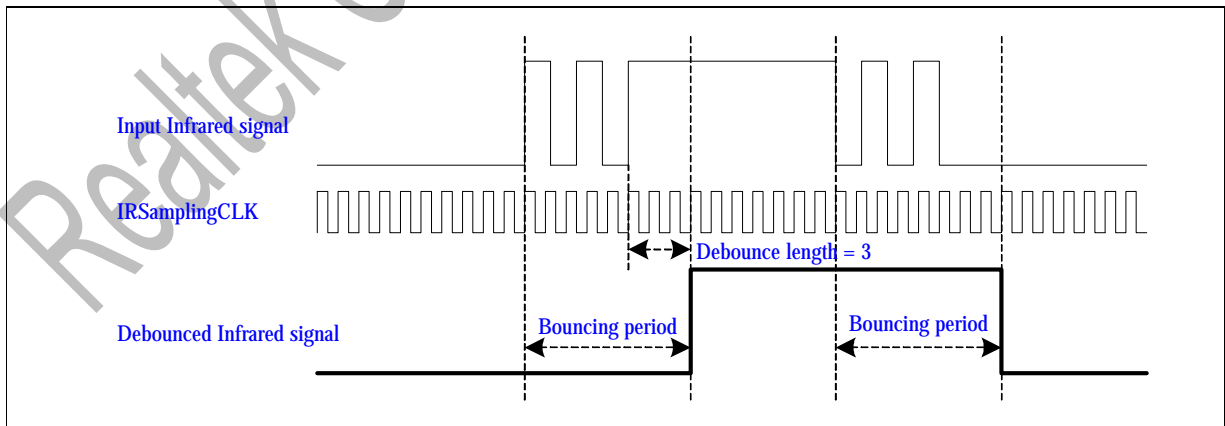

Infrared signal debounce timing chart

All length parameter must set just a little smaller than real definition. The Timing Registers must obey below condition

1. IR_SilenceLen >> IR_RepeatLen
2. IR_Data0Len >> IR_Data1Len
3. IR_BurstLen > IR_Data0Len, IR_Data1Len

Register:: IR_Burst_Length				0xFF82	
Name	Bits	R/W	Default	Comments	Config
burst_length	7:0	R/W	0x64	Remote burst length =(Value * 4) * IRSamplingCLK period	

Register:: IR_Silence_Length				0xFF83	
Name	Bits	R/W	Default	Comments	Config
silence_length	7:0	R/W	0x32	Remote silence length =(Value * 4) * IRSamplingCLK period	

Register:: IR_Repeat_Length				0xFF84	
Name	Bits	R/W	Default	Comments	Config
rpt_length	7:0	R/W	0x19	Remote repeat length =(Value * 4) * IRSamplingCLK period, for repeat command	

Register:: IR_Mod_Length				0xFF85	
Name	Bits	R/W	Default	Comments	Config
modu_length	7:0	R/W	0x19	Remote modulation length =Value * IRSamplingCLK period	

Register:: IR_Data0_Length				0xFF86	
Name	Bits	R/W	Default	Comments	Config
data0_high	7:0	R/W	0x19	Remote data zero length =Value * IRSamplingCLK period	

Register:: IR_Data1_Length				0xFF87	
Name	Bits	R/W	Default	Comments	Config
data1_high	7:0	R/W	0x4C	Remote data one length =Value *IRSamplingCLK period	

Register:: IR_Ctrl2				0xFF88	
Name	Bits	R/W	Default	Comments	Config
ph_len	7	R/W	1	Data Bit Coding Method 0: phase method 1: length method	
ph_len_inv	6	R/W	0	Data Bit Coding Mode 0: normal 1: invert Bit 7 bit 6: 00: phase coding method normal mode	

				01: phase coding method invert mode 10: length coding method normal mode 11: length coding method invert mode	
data_num	5:0	R/W	0x1F	Remote data number define number of bits of data (1~48)	

Register:: IR_Status				0xFF89	
Name	Bits	R/W	Default	Comments	Config
str_flag	7	R	0	Start Code flag (write 1 clear) This bit will be set to '1' when infrared decoder detects the Start Code.	Wclr_out
buf_ovf	6	R	0	Buffer Overflow flag 0: data buffer is not overflow 1: New IR data is received when all data buffers contain valid data. IR decoder will block IR data when Overflow flag is true. And Overflow flag is cleared automatically when any one of data buffer is empty.	
rd_buf_sel	5	R	0	Read buffer select 0: read buffer 0 1: read buffer 1 This bit indicates which buffer that be read via "Remote Data Access Port"	
buf1_flag	4	R	0	Buffer 1 flag 1: data valid This bit indicates buffer 1 has valid data or not.	
buf0_flag	3	R	0	Buffer 0 flag 1: data valid This bit indicates buffer 0 has valid data or not	
buf_rpt	2	R	0	Remote repeat event As infrared decoder detect "repeat code", this bit will be set to 1. The repeat event is true only when repeat code immediately follows a normal command, i.e. the infrared sequence "idle + repeat code" will not assert repeat flag and this "repeat code" will be ignored. Infrared decoder implements two layer repeat flag to indicate the repeat event of buffer1 and buffer2 As "repeat code" occurs, the previous received infrared data will be push into current FIFO and asserts data valid flag. Remote repeat event is cleared when correspond data is read from IR_Dataport_MSB. Buf1 -> Buf2 or Buf2 -> Buf1	
remote_tst	1	R/W	0	Remote test enable 0: selected IRSamplingCLK is set by IR_debounce[7:6] 1: IRSamplingCLK is crystal clock	
ir_sw_rstn	0	R/W	0	Remote soft reset 0: Reset, Blocking IR module 1: Enable IR module	

Register:: IR_Data0				0xFF8A	
Name	Bits	R/W	Default	Comments	Config
BYTE0	7:0	R	0	Remote data read port [7:0] From Buf1 or Buf2	

Register:: IR_Data1					0xFF8B
Name	Bits	R/W	Default	Comments	Config
BYTE1	7:0	R	0	Remote data read port [15:8] From Buf1 or Buf2	

Register:: IR_Data2					0xFF8C
Name	Bits	R/W	Default	Comments	Config
BYTE2	7:0	R	0	Remote data read port [23:16] From Buf1 or Buf2	

Register:: IR_Data3					0xFF8D
Name	Bits	R/W	Default	Comments	Config
BYTE3	7:0	R	0	Remote data read port [31:24] From Buf1 or Buf2	

Register:: IR_Data4					0xFF8E
Name	Bits	R/W	Default	Comments	Config
BYTE4	7:0	R	0	Remote data read port [39:32] From Buf1 or Buf2	

Register:: IR_Data5					0xFF8F
Name	Bits	R/W	Default	Comments	Config
BYTE5	7:0	R	0	Remote data read port [47:40] From Buf1 or Buf2	rport

- l The last bit (MSB) received is the MSB of data (port [47])
- l Data valid and repeat flag is clear when the port [47:40] is read.
- l If data is less than 48bit, the MSB is in port [47]. Other un-used bits are in lower bits.

Register:: IR_One_Cmd_Time					0xFF90
Name	Bits	R/W	Default	Comments	Config
one_cmd_time	7:0	R/W	0xA0	One Command Time =(Value * 32) * IRSamplingCLK period. The One Command Time is counting start when infrared detect the start code or data bit. Once the Timer start counting, infrared decoder can decode next command until the Timer timeout. Infrared decoder granted only one infrared is decoded during the One Command Time interval. This is used to reject noise. The value of One Command Time is usually a little smaller than the command period. When One Command Time is smaller than total bit time, the IR decoder can decode the IR data continuously.	

Register:: IR_Idle_Time					0xFF91
-------------------------	--	--	--	--	--------

Name	Bits	R/W	Default	Comments	Config
idle_time	7:0	R/W	0xA3	Idle Time =(Value * 32) * IRSamplingCLK_period. The Idle Time is counting start when infrared detect the start code or data bit. Infrared decoder goes into idle state when Idle Time out. This is used to prevent wrong “repeat code” detection. The value of Idle Time is usually a little larger than the command period. As Idle Time is smaller than total bit time, all input “repeat code” are invalid. As Idle Time is equal to 0xFF, all input “repeat code” are valid without Idle Time constraint.	

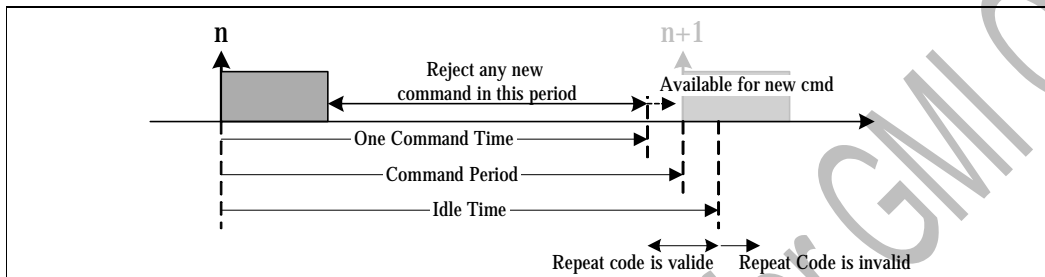

Infrared signal Command Time and Idle Time

Register:: IR_Ctrl3				0xFF92	
Name	Bits	R/W	Default	Comments	Config
DataNotEnough	7	R	0	Data Not Enough Event (write 1 clear) This event happens when received data bit less than Data_num 0: normal. 1: Data Not Enough Event Occurred, write 1 to clear this flag	Wclr_out
RxDataNum	6:1	R	0	Received Data Number RxDataNum indicates received data number when DataNotEnough event happens. RxDataNum is cleared when write 1 to DataNotEnough	
bit_swap	0	R/W	0	Bit Swap 0: The decoded IR bits is aligned to the MSB of IRDataPort. That means the last decode data is stored in the IRDataPort[47] 1: The decode IR bits is aligned to the LSB of IRDataPort. That means the last decode data is stored in the IRDataPort[0].	

Register:: IR_INTRQ				0xFF93	
Name	Bits	R/W	Default	Comments	Config
reserved	7:4	-	0	Reserved to 0	
flag0int_en	3	R/W	0	Buffer 0 data valid IRQ enable	
flag1int_en	2	R/W	0	Buffer 1 data valid IRQ enable	
rptint_en	1	R/W	0	Repeat event IRQ enable	
ovfint_en	0	R/W	0	Buffer Overflow IRQ enable	

Application example

	NEC	RC-5		
Non-Frist Cmd w/o start	0: disable	0: disable		
Input Inverse	0: disable	1: enable		
IRSamplingClock	0x0A IRSamplingClk =Xtal/512=24M/512 = 1/21.33 us De-Bounce =11 IRSampleCLK	0x0A IRSamplingClk =Xtal/512=24M/512 = 1/21.33 us De-Bounce =11 IRSampleCLK		
Burst Length	0x64 = 8.5ms < 9ms	X		
Silence Length	0x32 = 4.2ms < 4.5ms	X		
Repeat Length	0x19 = 2,1 ms < 2.25ms	X		
Modulation Length	0x19 = 533us < 560us	0x29 = 874us < 900us		
Data Zero Length	0x19 = 533us < 560us	X		
Data One Length	0x4C = 1.62ms < 1.69ms	X		
Infrared Control	0xDF Data bit coding = length Start code enable = true Codeing method = normal # Data bit = 32	0x0C Data bit coding = Phase Start code enable = False Codeing method = normal # Data bit = 13 (note: 1 st address bit is used as start condition)		
One Command Time	0xA0 = 109ms < 110ms	0xA5 = 112.6ms < 113.8ms		
Idle Time	0xA3 = 111ms > 110ms	X		

Register:: REV_DUMMY4					0xFF94	
Name	Bits	R/W	Default	Comments	Config	
REV_DUMMY4	7:0	R/W	00	Dummy4		

Pin Share

Register:: PIN_SHARE_CTRL00				0xFF96	
Name	Bits	Read/Write	Reset State	Comments	Config
DDC1	7	R/W	0x0	Pin58 (PAD_DDCSCL1) 0: DDCSCL1 <IO> <open-drain> <default> 1: reserved //normal output(refer bit6~5) Pin59 (PAD_DDCSDA1) 0: DDCSDA1 <IO> <open-drain> <default> 1: reserved //normal output(refer bit4~3)	
DDCSCL1	6:5	R/W	0x0	Pin58 00: P3D0i <I>	

				01: P3D0o <O> <open-drain> 10: P3D0o <O> <push-pull> 11: RXD <IO> <open-drain>	
DDCSDA1	4:3	R/W	0x0	Pin59 00: P3D1i <I> 01: P3D1o <O> <open-drain> 10: P3D1o <O> <push-pull> 11: TXD <O> <open-drain>	
P6D0	2:0	R/W	0x0	Pin50 (PAD_ADCA0) 000: P6D0i <I> <default> 001: P6D0o <O> <open-drain> 010: P6D0o <O> <push-pull> 011: ADCA0 <I> 100: AVOUT <AO> 101: VCLK <I>	

Register:: PIN_SHARE_CTRL01		0xFF97				
Name	Bits	Read/Write	Reset State	Comments	Config	
P6D1	7:6	R/W	0x0	Pin51 (PAD_ADCA1) 00: P6D1i <I> <default> 01: P6D1o <O> <open-drain> 10: P6D1o <O> <push-pull> 11: ADCA1 <I>		
P1D0	5:3	R/W	0x00	Pin64 (PAD_TCON0) 000: P1D0i <I> <default> 001: P1D0o <O> <open-drain> 010: P1D0o <O> <push-pull> 011: T2 <I> 100: SD0 <O> 101: SPDIF0 <O> 110: TCON[0] <O> 111: IrDA <I>		
P1D1	2:0	R/W	0x00	Pin65 (PAD_TCON1) 000: P1D1i <I> <default> 001: P1D1o <O> <open-drain> 010: P1D1o <O> <push-pull> 011: T2EX <I> 100: TCON[1] <O> 101: TCON[7] <O> 110: WS <O> 111: PWM1 <O>		

Register:: PIN_SHARE_CTRL_02		0xFF98				
Name	Bits	Read/Write	Reset State	Comments	Config	
P6D2	7:6	R/W	0x0	Pin52 (PAD_ADCA2) 00: P6D2i <I> <default> 01: P6D2o <O> <open-drain> 10: P6D2o <O> <push-pull> 11: ADCA2 <I>		
P1D2	5:3	R/W	0x0	Pin66 (PAD_TCON2) 000: P1D2i <I> <default> 001: P1D2o <O> <open-drain> 010: P1D2o <O> <push-pull> 011: CLKO <O>		

				100: SCK <O> 101: TCON[2] <O> 110: TCON[4] <O> <i>ie. Become BLU7 if single-port 8-bit TTL</i>	
P1D3	2:0	R/W	0x0	Pin67 (PAD_TCON5) 000: P1D3i <I> <default> 001: P1D3o <O> <open-drain> 010: P1D3o <O> <push-pull> 011: MCK <O> 100: TCON[5] <O> 101: TCON[9] <O> <i>ie. Become BLU6 if single-port 8-bit TTL</i>	

Register:: PIN_SHARE_CTRL03 0xFF99					
Name	Bits	Read/Write	Reset State	Comments	Config
P6D3	7:6	R/W	0x0	Pin53 (PAD_ADCA3) 00: P6D3i <I> <default> 01: P6D3o <O> <open-drain> 10: P6D3o <O> <push-pull> 11: ADCA3 <I>	
P1D5	5:3	R/W	0x0	Pin69 (PAD_TCON3) 000: P1D5i <I> <default> 001: P1D5o <O> <open-drain> 010: P1D5o <O> <push-pull> 011: SD1 <O> 100: TCON[3] <O> 101: TCON[7] <O> 110: SPDIF1 <O> 111: IIC_SCL <IO> <open-drain> <i>ie. Become BLU4 if single-port 8-bit TTL</i>	
P1D6	2:0	R/W	0x0	Pin70 (PAD_TCON9) 000: P1D6i <I> <default> 001: P1D6o <O> <open-drain> 010: P1D6o <O> <push-pull> 011: SD2 <O> 100: TCON[9] <O> 101: TCON[11] <O> 110: SPDIF2 <O> 111: IIC_SDA <IO> <open-drain> <i>ie. Become BLU3 if single-port 8-bit TTL</i>	

Register:: PIN_SHARE_CTRL04 0xFF9A					
Name	Bits	Read/Write	Reset State	Comments	Config
P6D5	7:5	R/W	0x0	Pin55 (PAD_ADCB0) 000: P6D5i <I> <default> 001: P6D5o <O> <open-drain> 010: P6D5o <O> <push-pull> 011: ADCB0 <I> 100: PWM1 <O> 101: PWM5 <O>	
P6D6_7	4	R/W	0	Pin56 (PAD_ADCB1) 0: reserved //normal output(refer bit3~2) <default> 1: IIC_SCL <IO> <open-drain> Pin57 (PAD_ADCB2)	

				0: reserved //normal output(refer bit1~0) <default> 1: IICSDA <IO> <open-drain>	
P6D6	3:2	R/W	0x0	Pin56 00: P6D6i <I> <default> 01: P6D6o <O> <open-drain> 10: P6D6o <O> <push-pull> 11: ADCB1 <I>	
P6D7	1:0	R/W	0x0	Pin57 00: P6D7i <I> <default> 01: P6D7o <O> <open-drain> 10: P6D7o <O> <push-pull> 11: ADCB2 <I>	

Register:: PIN_SHARE_CTRL05		0xFF9B			
Name	Bits	Read/Write	Reset State	Comments	Config
Reserved	7	R/W	0	reserved to 0	
P1D4	6:4	R/W	0x0	Pin68 (PAD_TCON13) 000: P1D4i <I> <default> 001: P1D4o <O> <open-drain> 010: P1D4o <O> <push-pull> 011: SD0 <O> 100: TCON[3] <O> 101: TCON[13] <O> 110: SPDIF0 <O> <i>ie. Become BLU5 if single-port 8-bit TTL</i>	
P1D7	3:0	R/W	0x0	Pin71 (PAD_TCON8) 0000: P1D7i <I> <default> 0001: P1D7o <O> <open-drain> 0010: P1D7o <O> <push-pull> 0011: SD3 <O> 0100: TCON[8] <O> 0101: TCON[10] <O> 0110: SPDIF3 <O> 0111: PWM1 <O> 1000: PWM5 <O> <i>ie. Become BLU2 if single-port 8-bit TTL</i>	

Register:: PIN_SHARE_CTRL06		0xFF9C			
Name	Bits	Read/Write	Reset State	Comments	Config
P6D4	7:6	R/W	0x0	Pin54 (PAD_ADCA4) 00: P6D4i <I> <default> 01: P6D4o <O> <open-drain> 10: P6D4o <O> <push-pull> 11: ADCA4 <I>	
P5D2	5:3	R/W	0x0	Pin96 (PAD_PWM0) 000: P5D2i <I> <default> 001: P5D2o <O> <open-drain> 010: P5D2o <O> <push-pull> 011: PWM0 <O> 100: DCLK <O>	
P5D3	2:0	R/W	0x0	Pin97 (PAD_PWM1) 000: P5D3i <I> <default> 001: P5D3o <O> <open-drain> 010: P5D3o <O> <push-pull>	

				011: PWM1 <O> 100: DVS <O>	
--	--	--	--	-------------------------------	--

Register:: PIN_SHARE_CTRL07 0xFF9D					
Name	Bits	Read/Write	Reset State	Comments	Config
TXE0P	7:6	R/W	0x0	Pin94 00: P5D0o <O> <push-pull> <default> 01: TCON[0] <O> 10: DENA <O>	
Reserved	7:6	R/W	0x0	reserved to 0	
P9PA	7:6	R/W	0x0	Pin74-83 00: None <default> 10: GPI 11: GPO (push-pull) ie. active if single-port LVDS without E/O swap	
P5D5	5:3	R/W	0x0	Pin99 (PAD_PWM3) 000: P5D5i <I> <default> 001: P5D5o <O> <open-drain> 010: P5D5o <O> <push-pull> 011: PWM3 <O> 100: TCON[6] <O> 101: TCON[11] <O>	
P5D6	2:0	R/W	0x0	Pin100 (PAD_PWM4) 000: P5D6i <I> <default> 001: P5D6o <O> <open-drain> 010: P5D6o <O> <push-pull> 011: PWM4 <O> 100: TCON[3] <O> 101: TCON[12] <O>	

Register:: PIN_SHARE_CTRL08 0xFF9E					
Name	Bits	Read/Write	Reset State	Comments	Config
Reserved	7:6	R/W	0x0	reserved to 0	
P7D6	5:3	R/W	0x0	Pin102 (PAD_SPDIF3) 000: P7D6i <I> <default> 001: P7D6o <O> <open-drain> 010: P7D6o <O> <push-pull> 011: PWM0 <O> 100: SD3 <O> 101: SPDIF3 <O> 110: TCON[10] <O> 111: DCLK <O>	
P8D0	2:0	R/W	0x0	Pin105 (PAD_SPDIF0) 000: P8D0i <I> <default> 001: P8D0o <O> <open-drain> 010: P8D0o <O> <push-pull> 011: TCON[9] <O> 100: SD0 <O> 101: SPDIF0 <O>	

Register:: PIN_SHARE_CTRL09 0xFF9F					
Name	Bits	Read/Write	Reset State	Comments	Config
P5D4	7:6	R/W	0x0	Pin98 (PAD_PWM2)	

				00: P5D4i <I> <default> 01: P5D4o <O> <open-drain> 10: P5D4o <O> <push-pull> 11: PWM2 <O>	
P5D7	5:3	R/W	0x0	Pin101 (PAD_PWM5) 000: P5D7i <I> <default> 001: P5D7o <O> <open-drain> 010: P5D7o <O> <push-pull> 011: PWM5 <O> 100: TCON[0] <O>	
P8D1	2:0	R/W	0x0	Pin108 (PAD_MCK) 000: P8D1i <I> <default> 001: P8D1o <O> <open-drain> 010: P8D1o <O> <push-pull> 011: CLKO <O> 100: MCK <O> 101: TCON[7] <O>	

Register:: PIN_SHARE_CTRL0A				0xFFA0	
Name	Bits	Read/Write	Reset State	Comments	Config
Reserved	7	R/W	0	reserved to 0	
P7D5	6:4	R/W	0x0	Pin103 (PAD_SPDIF2) 000: P7D5i <I> <default> 001: P7D5o <O> <open-drain> 010: P7D5o <O> <push-pull> 011: PWM1 <O> 100: SD2 <O> 101: SPDIF2 <O> 110: TCON[8] <O> 111: IIC_SCL <IO> <open-drain>	
P7D4	3:1	R/W	0x0	Pin104 (PAD_SPDIF1) 000: P7D4i <I> <default> 001: P7D4o <O> <open-drain> 010: P7D4o <O> <push-pull> 011: SD1 <O> 100: IRQ <O> 101: TCON[5] <O> 110: SPDIF1 <O> 111: IIC_SDA <IO> <open-drain>	
Reserved	0	R/W	0	reserved to 0	

Register:: PIN_SHARE_CTRL0B				0xFFA1	
Name	Bits	Read/Write	Reset State	Comments	Config
Reserved	7	R/W	0	reserved to 0	
P3D2	6:4	R/W	0x0	Pin109 (PAD_SCK) 000: P3D2i <I> <default> 001: P3D2o <O> <open-drain> 010: P3D2o <O> <push-pull> 011: INT0 <I> 100: TCON[3] <O> 101: SCK <O>	
Reserved	3	R/W	0	reserved to 0	
P3D3	2:0	R/W	0x0	Pin110 (PAD_WS) 000: P3D3i <I> <default>	

				001: P3D3o <O> <open-drain> 010: P3D3o <O> <push-pull> 011: INT1 <I> 100: TCON[6] <O> 101: WS <O>	
--	--	--	--	---	--

Register:: PIN_SHARE_CTRL0C			0xFFA2		
------------------------------------	--	--	---------------	--	--

Name	Bits	Read/Write	Reset State	Comments	Config
Reserved	7	R/W	0	reserved to 0	
P3D4	6:4	R/W	0x0	Pin111 (PAD_SD0) 000: P3D4i <I> <default> 001: P3D4o <O> <open-drain> 010: P3D4o <O> <push-pull> 011: T0 <I> 100: TCON[4] <O> 101: SD0 <O> 110: SPDIF0 <O>	
Reserved	3	R/W	0	reserved to 0	
P3D5	2:0	R/W	0x0	Pin112 (PAD_SD1) 000: P3D5i <I> <default> 001: P3D5o <O> <open-drain> 010: P3D5o <O> <push-pull> 011: T1 <I> 100: TCON[9] <O> 101: SD1 <O> 110: SPDIF1 <O>	

Register:: PIN_SHARE_CTRL0D			0xFFA3		
------------------------------------	--	--	---------------	--	--

Name	Bits	Read/Write	Reset State	Comments	Config
Reserved	7	R/W	0	reserved to 0	
P3D6	6:4	R/W	0x0	Pin113 (PAD_SD2) 000: P3D6i <I> <default> 001: P3D6o <O> <open-drain> 010: P3D6o <O> <push-pull> 011: TCON[1] <O> 100: SD2 <O> 101: SPDIF2 <O> 110: IrDA <I>	
Reserved	3	R/W	0	reserved to 0	
P3D7	2:0	R/W	0x0	Pin114 (PAD_SD3) 000: P3D7i <I> <default> 001: P3D7o <O> <open-drain> 010: P3D7o <O> <push-pull> 011: TCON[13] <O> 100: SD3 <O> 101: SPDIF3 <O> 110: VCLK <I>	

Register:: PIN_SHARE_CTRL0E			0xFFA4		
------------------------------------	--	--	---------------	--	--

Name	Bits	Read/Write	Reset State	Comments	Config
DDCSCL2	7:6	R/W	0x0	Pin124 (PAD_DDCSCL2) 00: DDCSCL2 <IO> <default> 01: P7D0i <I>	

				10: P7D0o <O> <open-drain> 11: P7D0o <O> <push-pull>
DDCSDA2	5:4	R/W	0x0	Pin123 (PAD_DDCSDA2) 00: DDCSDA2 <IO> <default> 01: P7D1i <I> 10: P7D1o <O> <open-drain> 11: P7D1o <O> <push-pull>
DDCSDA3	3:2	R/W	0x0	Pin122 (PAD_DDCSDA3) 00: DDCSDA3 <IO> <default> 01: P7D2i <I> 10: P7D2o <O> <open-drain> 11: P7D2o <O> <push-pull>
DDCSCL3	1:0	R/W	0x0	Pin121 (PAD_DDCSCL3) 00: DDCSCL3 <IO> <default> 01: P7D3i <I> 10: P7D3o <O> <open-drain> 11: P7D3o <O> <push-pull>

Register:: TST_CLK_CTRL 0xFFA5					
Name	Bits	Read/Write	Reset State	Comments	Config
DPLL_OEN	7	R/W	0	DPLL frequency output enable 0: output disabled 1: output enabled	
M2pll_OEN	6	R/W	0	M2PLL frequency output enable 0: output disabled 1: output enabled	
Audio_pll_OEN	5	R/W	0	Audio_PLL frequency output enable 0: output disabled 1: output enabled	
CLK_PLL27X_OEN	4	R/W	0	CLK_PLL27X frequency output enable 0: output disabled 1: output enabled	
CLK108_PLL27X_OEN	3	R/W	0	CLK108_PLL27X frequency output enable 0: output disabled 1: output enabled	
Test1out_OEN	2	R/W	0	Test1out frequency output enable 0: output disabled 1: output enabled	
Test2out_OEN	1	R/W	0	Test2out frequency output enable 0: output disabled 1: output enabled	
Fav4_OEN	0	R/W	0	Fav4 frequency output enable 0: output disabled 1: output enabled	

Register:: PIN_DRIVING_CTRL10 0xFFA6					
Name	Bits	Read/Write	Reset State	Comments	Config
PIN50_54	7	R/W	0	Driving Current Control01 – Pin50-54 0: Low 1: High	
PIN55_57	6	R/W	0	Driving Current Control02– Pin55~57 0: Low 1: High	
PIN58_59	5	R/W	0	Driving Current Control00 – Pin58-59	

				0: Low 1: High	
PIN64_67	4	R/W	0	Driving Current Control03 – Pin64~67 0: Low 1: High	
PIN68_71	3	R/W	0	Driving Current Control04 – Pin68~71 0: Low 1: High	
PIN74_95	2:1	R/W	0x2	Driving Current Control05 – Pin74~83-86~95 - TTL x0: Low x1: High - LVDS 00: 2.5mA 01: 3.0mA 10: 3.5mA 11: 4.0mA	
PIN96_97	0	R/W	0	Driving Current Control06 – Pin96~97 0: Low 1: High	

Register:: PIN_DRIVING_CTRL11		0xFFA7			
Name	Bits	Read/Write	Reset State	Comments	Config
PIN98_103	7	R/W	0	Driving Current Control07 – Pin98~103 0: Low 1: High	
PIN104_105	6	R/W	0	Driving Current Control08 – Pin104~105 0: Low 1: High	
PIN108_114	5	R/W	0	Driving Current Control09– Pin108~114 0: Low 1: High	
PIN115_118	4	R/W	0	Driving Current Control0A – Pin115~118 0: Low 1: High	
PIN121_124	3	R/W	0	Driving Current Control0B – Pin121~124 0: Low 1: High	
Reserved	2:0	R/W	0x0	reserved to 0	

Register:: PIN_PULLUP_CTRL20		0xFFA8			
Name	Bits	Read/Write	Reset State	Comments	Config
PIN50_54	7	R/W	0	Pull Up Control01 – Pin50~54 0: Disable 1: Enable (active only in GPI or open-drain case)	
PIN55_57	6	R/W	0	Pull Up Control02– Pin55~57 0: Disable 1: Enable (active only in GPI or open-drain case)	
PIN58_59	5	R/W	0	Pull Up Control00 – Pin58~59 0: Disable 1: Enable (active only in GPI or open-drain case)	
PIN64_67	4	R/W	0	Pull Up Control03 – Pin64~67 0: Disable 1: Enable (active only in GPI or open-drain case)	

PIN68_71	3	R/W	0	Pull Up Control04 – Pin68~71 0: Disable 1: Enable (active only in GPI or open-drain case)	
Reserved	2:1	R/W	0	reserved to 0	
PIN96_97	0	R/W	0	Pull Up Control06 – Pin96~97 0: Disable 1: Enable (active only in GPI or open-drain case)	

Register:: PIN_PULLUP_CTRL21 0xFFA9					
Name	Bits	Read/Write	Reset State	Comments	Config
PIN98_103	7	R/W	0	Pull Up Control07 – Pin98~103 0: Disable 1: Enable (active only in GPI or open-drain case)	
PIN104_105	6	R/W	0	Pull Up Control08 – Pin104~105 0: Disable 1: Enable (active only in GPI or open-drain case)	
PIN108_114	5	R/W	0	Pull Up Control09 – Pin108~114 0: Disable 1: Enable (active only in GPI or open-drain case)	
Reserved	4	R/W	0x0	reserved to 0	
PIN121_124	3	R/W	0	Pull Up Control10B – Pin121~124 0: Disable 1: Enable (active only in GPI or open-drain case)	
Reserved	2	R/W	0x0	reserved to 0	
XCLK_OEN	1	R/W	0	XCLK frequency output enable 0: output disabled 1: output enabled	
CKT_PLL27X_OEN	0	R/W	0	CKT_PLL27X frequency output enable 0: output disabled 1: output enabled	

CEC function

CEC Control Register

In CEC function, write_reg pulses should have distances larger than 3 XTAL clk period at least.

Register:: cec_cr_1 0xFFAA					
Name	Bits	R/W	Default	Comments	Config
Reserved	7:5	--	--		
ini_adr_sel	4	R/W	0	1:initial address change 0:use original address	
ini_adr	3:0	R/W	0x1	Initial address when ini_adr_sel = 1	

Register::cec_cr0 0xFFAB					
Name	Bits	R/W	Default	Comments	Config
cec_mode	7:6	R/W	0x0	00: Disable CEC module 01: Enable CEC Normal Operation 10: PAD Output Test Mode.	

				11: Digital Loopback, Tx Data will be loopback before PAD. Note. 1. As CEC module is disabled, RX will not ACK any transaction which destination address is the same with CECLOCADDR or 0xf.	
test_mode_pad_data	5	R/W	0x1	0: CEC PAD output low 1: CEC PAD output high	
test_mode_pad_en	4	R/W	0x0	0 : output high impedance 1 : PAD output enable This bit is active with CEC_Mode=10 only.	
logical_addr	3:0	R/W	0xF	CEC device logical (local) address	

Register::cec_cr1						0xFFAC					
Name	Bits	R/W	Default	Comments		Config					
timer_div	7:0	R/W	0x14	DAC ENP(Enable Pulse) divides into Timer Enable Pulse. And Timer Enable Pulse is equal to Input Sample Enable Pulse. Its default value is 0.8MHz divides into 20 to 40KHz(25us). ° CEC clock frequency is used for the bit timers in the receiver and transmitter modes.							

Register::cec_cr2						0xFFAD					
Name	Bits	R/W	Default	Comments		Config					
pre_div	7:0	R/W	0x21	Divisor for CEC DAC Clock BusCLK CECDiv CK_CEC 162MHz 202 0.8019MHz 27MHz 33 0.8182MHz							

Register::cec_cr3						0xFFAE					
Name	Bits	R/W	Default	Comments		Config					
unreg_ack_en	7	R/W	0x0	If rx logical addr = 0xF, when receiving a broadcast signal (destination addr = 0xF) 1 : response ack 2 : non to response ack							
pad_s_ctrl	6:5	R/W	0x1	CEC PAD Current Control of Charge Pump 00: 0.75 uA 01: 1 uA 10: 1.25 uA 11: 1.5 uA							
pad_delay	4:0	R/W	0x03	The delay from CEC PAD going high to being disable. Delay: (1+CECPADDELAY)*25us Typical Value: 01~03 (50us~100us) For Normal Mode only.							

Register::cec_rt0						0xFFAF					
Name	Bits	R/W	Default	Comments		Config					
cec_rt0_rsv	7:6	R/W	0x0	Reserved Register							
wt_cnt	5:0	R	-	Retry Wait Time							

Register::cec_rt1						0xFFB0					
-------------------	--	--	--	--	--	--------	--	--	--	--	--

Name	Bits	R/W	Default	Comments	Config
cec_rt1_rsv	7:5	R/W	0x0		
lattest	4	R	-	1: The last initiator own CEC bus is this device	
retry_no	3:0	R/W	0x5	Maximum re-transmission times for a single frame, when device is a initiator and device detect low impedance error. In continue mode, retry is inactive.	

Register::cec_rx0 0xFFB1					
Name	Bits	R/W	Default	Comments	Config
rx_en	7	R	-	Write 1 to enable Rx As CEC_enable=1 and CECRxEn=0, RX will ACK the transaction which destination address is the same with CECLOCADDR or 0xf	wclr_out
rx_rst	6	R/W	0x0	Write 1 to reset Rx State and its FIFO status After finishing each transaction, software should reset Rx part to clear CECRxEOM, CECRxINT and CECRxFIFOov status bits.	
rx_continuous	5	R/W	0x0	0/1 : Normal mode / Continuous mode In continuous mode, RxINT will be set to 1 when Rx receive new 8 bytes or EOM. In normal mode, RxINT will be set to 1 iff Rx receive EOM.	
rx_int_en	4	R/W	0x0	1 : CEC Rx interrupt enable If enabled, hardware will trigger interrupt per 8 bytes received or EOM	
init_addr	3:0	R	-	The latest Initiator Address (when device is a follower)	

Register::cec_rx1 0xFFB2					
Name	Bits	R/W	Default	Comments	Config
rx_eom	7	R	-	When EOM is received, RxEn will be reset to 0 and RxINT will be set to 1.	
rx_int	6	R	-	1 : CEC Rx interrupt pending (write 1 to clear)	wclr_out
rx_fifo_ov	5	R	-	1 : Overflow status for CEC 16-byte FIFO	
rx_fifo_cnt	4:0	R	-	The number of byte has been received by Rx	

Register::cec_tx0 0xFFB3					
Name	Bits	R/W	Default	Comments	Config
tx_en	7	R	-	Write 1 to enable Tx transmission Tx will detect signal free time, and then transmission and re-try automatically.	wclr_out
tx_rst	6	R/W	0x0	Write 1 to reset Tx State and its FIFO status After finishing each transaction, software should reset Tx part to clear CECTxEOM, CECTxINT and CECTxFIFOud status bits.	
tx_continuous	5	R/W	0x0	Tx continuous mode 0: Normal mode 1: Continuous mode, software should clear this bit as the last byte is written into Tx FIFO to indicate the end of transmitting data.	

tx_int_en	4	R/W	0x0	1 : CEC Tx interrupt enable If enabled, hardware will trigger interrupt per 8 bytes transmitted or EOM	
dest_addr	3:0	R/W	0x0	Destination Address (when device is a initiator)	

Register::cec_tx1		0xFFB4			
Name	Bits	R/W	Default	Comments	Config
tx_eom	7	R	-	The transmission has ended.	
tx_int	6	R	-	1 : CEC Tx interrupt pending (write 1 to clear)	wclr_out
tx_fifo_ud	5	R	-	1 : Underflow status for CEC 16-byte Tx FIFO	
tx_fifo_cnt	4:0	R	-	The number of byte will been transmitted by Tx	

Note : following table illustrates the status with the combination of CECTxEn, CECTxEOM, CECTxINT and CECTxContinue after transmitting.

	CECTxEn	CECTxEOM	CECTxINT	CECTxContinue
Complete transmission incorrectly and not in Continue Mode	0	0	1	0
Complete transmission correctly and not in Continue Mode	0	1	1	0
Complete transmission incorrectly and in Continue Mode	0	0	1	0
Transmitted 8 bytes correctly and still in Continue Mode, software should push data into Tx fifo as necessary	1	0	1	1
Complete transmission and in Continue Mode	0	1	1	0 (because software clear to 0 after pushing remaining datum into TX fifo)
TX fifo is underflow (in continue mode only) Note : this is the same with CECTxFIFOud=1	0	0	1	1

Register::cec_tx_fifo		0xFFB5			
Name	Bits	R/W	Default	Comments	Config
tx_dat	7:0	R/W	-	Tx FIFO data output port	rport wport

Register::cec_rx_fifo		0xFFB6			
Name	Bits	R/W	Default	Comments	Config
rx_dat	7:0	R/W	-	Rx FIFO data input port	rport wport

Register::cec_rx_start0		0xFFB7				
Name	Bits	R/W	Default	Comments	Config	
rx_start_low	7:0	R/W	0x8C	Minimum width (3.5ms)		

Register::cec_rx_start1		0xFFB8				
Name	Bits	R/W	Default	Comments	Config	
rx_start_period	7:0	R/W	0xBC	Maximum width (4.7ms)		

Register::cec_rx_data0		0xFFB9				
Name	Bits	R/W	Default	Comments	Config	
rx_data_sample	7:0	R/W	0x2A	Sample Time (1.05ms)		

Register::cec_rx_data1		0xFFBA				
Name	Bits	R/W	Default	Comments	Config	
rx_data_period	7:0	R/W	0x52,	Minimum data bit width (2.05ms)		

Register::cec_tx_start0		0xFFBB				
Name	Bits	R/W	Default	Comments	Config	
tx_start_low	7:0	R/W	0x94	3.7ms (0.025*148)		

Register::cec_tx_start1		0xFFBC				
Name	Bits	R/W	Default	Comments	Config	
tx_start_high	7:0	R/W	0x20	0.8ms (4.5ms – 3.7ms)		

Register::cec_tx_data0		0xFFBD				
Name	Bits	R/W	Default	Comments	Config	
tx_data_low	7:0	R/W	0x18	0.6ms		

Register::cec_tx_data1		0xFFBE				
Name	Bits	R/W	Default	Comments	Config	
tx_data_01	7:0	R/W	0x24	0.9ms		

Register::cec_tx_data2		0xFFBF				
Name	Bits	R/W	Default	Comments	Config	
tx_data_high	7:0	R/W	0x24	0.9ms		

MCU register 3 (Page F)
GPIO Control

Register::Port_read_control				0xFFC0	
Name	Bits	R/W	Default	Comments	Config
PA_pin_reg_n	7	R/W	0	Source selection for PA read back 0: register 1: bus value	
P9_pin_reg_n	6	R/W	0	Source selection for P9 read back 0: register 1: bus value	
P8_pin_reg_n	5	R/W	0	Source selection for P8 read back 0: register 1: bus value	
P7_pin_reg_n	4	R/W	0	Source selection for P7 read back 0: register 1: bus value	
P6_pin_reg_n	3	R/W	0	Source selection for P6 read back 0: register 1: bus value	
P5_pin_reg_n	2	R/W	0	Source selection for P5 read back 0: register 1: bus value	
P3_pin_reg_n	1	R/W	0	Source selection for P3 read back* 0: register 1: bus value	
P1_pin_reg_n	0	R/W	0	Source selection for P1 read back* 0: register 1: bus value	

*: only effect in external MCU control, embedded MCU will control the source by assembly code.

Register::Port52_pin_reg				0xFFC1	
Name	Bits	R/W	Default	Comments	Config
Reserved	7:1	--	0	Reserved	

P52	0	R/W	1	Input/output value of P5.2	Rport wport
-----	---	-----	---	----------------------------	----------------

Register::Port53_pin_reg 0xFFC2					
Name	Bits	R/W	Default	Comments	Config
Reserved	7:1	--	0	Reserved	
P53	0	R/W	1	Input/output value of P5.3	Rport wport

Register::Port54_pin_reg 0xFFC3					
Name	Bits	R/W	Default	Comments	Config
Reserved	7:1	--	0	Reserved	
P54	0	R/W	1	Input/output value of P5.4	Rport wport

Register::Port55_pin_reg 0xFFC4					
Name	Bits	R/W	Default	Comments	Config
Reserved	7:1	--	0	Reserved	
P55	0	R/W	1	Input/output value of P5.5	Rport wport

Register::Port56_pin_reg 0xFFC5					
Name	Bits	R/W	Default	Comments	Config
Reserved	7:1	--	0	Reserved	
P56	0	R/W	1	Input/output value of P5.6	Rport wport

Register::Port57_pin_reg 0xFFC6					
Name	Bits	R/W	Default	Comments	Config
Reserved	7:1	--	0	Reserved	
P57	0	R/W	1	Input/output value of P5.7	Rport wport

Register::Port60_pin_reg 0xFFC7					
Name	Bits	R/W	Default	Comments	Config
Reserved	7:1	--	0	Reserved	
P60	0	R/W	1	Input/output value of P6.0	Rport wport

Register::Port61_pin_reg 0xFFC8					
Name	Bits	R/W	Default	Comments	Config
Reserved	7:1	--	0	Reserved	
P61	0	R/W	1	Input/output value of P6.1	Rport wport

Register::Port62_pin_reg 0xFFC9					
Name	Bits	R/W	Default	Comments	Config
Reserved	7:1	--	0	Reserved	
P62	0	R/W	1	Input/output value of P6.2	Rport wport

Register::Port63_pin_reg 0xFFCA					
Name	Bits	R/W	Default	Comments	Config

Reserved	7:1	--	0	Reserved	
P63	0	R/W	1	Input/output value of P6.3	Rport wport

Register::Port64_pin_reg 0xFFCB					
Name	Bits	R/W	Default	Comments	Config
Reserved	7:1	--	0	Reserved	
P64	0	R/W	1	Input/output value of P6.4	Rport wport

Register::Port65_pin_reg 0xFFCC					
Name	Bits	R/W	Default	Comments	Config
Reserved	7:1	--	0	Reserved	
P65	0	R/W	1	Input/output value of P6.5	Rport wport

Register::Port66_pin_reg 0xFFCD					
Name	Bits	R/W	Default	Comments	Config
Reserved	7:1	--	0	Reserved	
P66	0	R/W	1	Input/output value of P6.6	Rport wport

Register::Port67_pin_reg 0xFFCE					
Name	Bits	R/W	Default	Comments	Config
Reserved	7:1	--	0	Reserved	
P67	0	R/W	1	Input/output value of P6.7	Rport wport

Register::Port70_pin_reg 0xFFCF					
Name	Bits	R/W	Default	Comments	Config
Reserved	7:1	--	0	Reserved	
P70	0	R/W	1	Input/output value of P7.0	Rport wport

Register::Port71_pin_reg 0xFFD0					
Name	Bits	R/W	Default	Comments	Config
Reserved	7:1	--	0	Reserved	
P71	0	R/W	1	Input/output value of P7.1	Rport wport

Register::Port72_pin_reg 0xFFD1					
Name	Bits	R/W	Default	Comments	Config
Reserved	7:1	--	0	Reserved	
P72	0	R/W	1	Input/output value of P7.2	Rport wport

Register::Port73_pin_reg 0xFFD2					
Name	Bits	R/W	Default	Comments	Config
Reserved	7:1	--	0	Reserved	
P73	0	R/W	1	Input/output value of P7.3	Rport wport

Register::Port74_pin_reg 0xFFD3					
Name	Bits	R/W	Default	Comments	Config

Reserved	7:1	--	0	Reserved	
P74	0	R/W	1	Input/output value of P7.4	Rport wport

Register::Port75_pin_reg 0xFFD4					
Name	Bits	R/W	Default	Comments	Config
Reserved	7:1	--	0	Reserved	
P75	0	R/W	1	Input/output value of P7.5	Rport wport

Register::Port76_pin_reg 0xFFD5					
Name	Bits	R/W	Default	Comments	Config
Reserved	7:1	--	0	Reserved	
P76	0	R/W	1	Input/output value of P7.6	Rport wport

Register::Port80_pin_reg 0xFFD6					
Name	Bits	R/W	Default	Comments	Config
Reserved	7:1	--	0	Reserved	
P80	0	R/W	1	Input/output value of P8.0	Rport wport

Register::Port81_pin_reg 0xFFD7					
Name	Bits	R/W	Default	Comments	Config
Reserved	7:1	--	0	Reserved	
P81	0	R/W	1	Input/output value of P8.1	Rport wport

Register::Port90_pin_reg						0xFFD8					
Name	Bits	R/W	Default	Comments		Config					
Reserved	7:1	--	0	Reserved							
P90	0	R/W	1	Input/output value of P9.0		Rport wport					

Register::Port91_pin_reg						0xFFD9					
Name	Bits	R/W	Default	Comments		Config					
Reserved	7:1	--	0	Reserved							
P91	0	R/W	1	Input/output value of P9.1		Rport wport					

Register::Port92_pin_reg						0xFFDA					
Name	Bits	R/W	Default	Comments		Config					
Reserved	7:1	--	0	Reserved							
P92	0	R/W	1	Input/output value of P9.2		Rport wport					

Register::Port93_pin_reg						0xFFDB					
Name	Bits	R/W	Default	Comments		Config					
Reserved	7:1	--	0	Reserved							
P93	0	R/W	1	Input/output value of P9.3		Rport wport					

Register::Port94_pin_reg						0xFFDC					
Name	Bits	R/W	Default	Comments		Config					
Reserved	7:1	--	0	Reserved							

P94	0	R/W	1	Input/output value of P9.4	Rport wport
-----	---	-----	---	----------------------------	----------------

Register::Porta0_pin_reg 0xFFDD					
Name	Bits	R/W	Default	Comments	Config
Reserved	7:1	--	0	Reserved	
PA0	0	R/W	1	Input/output value of PA.0	Rport wport

Register::Porta1_pin_reg 0xFFDE					
Name	Bits	R/W	Default	Comments	Config
Reserved	7:1	--	0	Reserved	
PA1	0	R/W	1	Input/output value of PA.1	Rport wport

Register::Porta2_pin_reg 0xFFDF					
Name	Bits	R/W	Default	Comments	Config
Reserved	7:1	--	0	Reserved	
PA2	0	R/W	1	Input/output value of PA.2	Rport wport

Register::Porta3_pin_reg 0xFFE0					
Name	Bits	R/W	Default	Comments	Config
Reserved	7:1	--	0	Reserved	
PA3	0	R/W	1	Input/output value of PA.3	Rport wport

Register::Porta4_pin_reg 0xFFE1					
---------------------------------	--	--	--	--	--

Name	Bits	R/W	Default	Comments	Config
Reserved	7:1	--	0	Reserved	
PA4	0	R/W	1	Input/output value of PA.4	Rport wport

SFR Access

When embedded MCU is selected, the P1, P3 GPIO is controlled by SFR. Both of the port groups must be access by below registers when using external MCU. Below registers are useless when embedded MCU is adopted.

Register::Port1_pin_reg					0xFFE2
Name	Bits	R/W	Default	Comments	Config
P1	7:0	R/W	0xFF	Input/output value of P1	Rport Wport

Register::Port3_pin_reg					0xFFE3
Name	Bits	R/W	Default	Comments	Config
P3	7:0	R/W	0xFF	Input/output value of P3	Rport Wport

Register:: REV_DUMMY5					0xFFE4
Name	Bits	R/W	Default	Comments	Config
REV_DUMMY5	7:0	R/W	00	Dummy5	

Watchdog Timer

The Watchdog Timer automatically generates a device reset when it is overflowed. The interval of overflow is about 0.23 sec to 1.84 sec(assume crystal is 27MHz) and can be programmed via register CNT1.

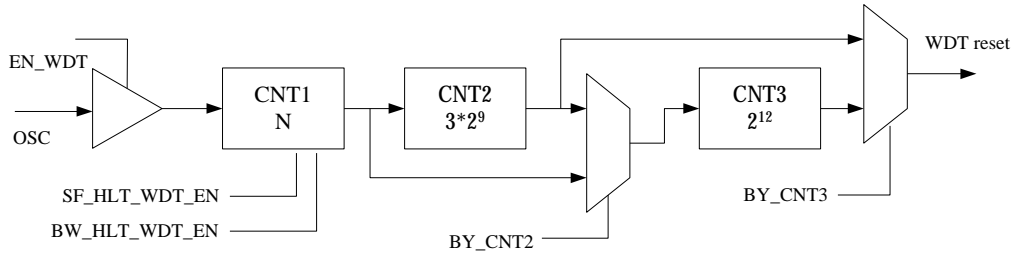

Register::WATCHDOG_timer		0xFFEA			
Name	Bits	R/W	Default	Comments	Config
EN_WDT	7	R/W	1	0: Disable watchdog timer 1: Enable watchdog timer	
CLR_WDT	6	W	0	0: No effect 1: Clear all counters of watchdog	Rport Wport
SF_HLT_WDT_EN	5	R/W	0	1: Stop watchdog counter by SPI-FLASH access	
BW_HLT_WDT_EN	4	R/W	0	1: Stop watchdog counter by scalar burst write action	
reserved	3	--	0	Reserved	
CNT1	2:0	R/W	0	The number N of counter1 000~111: 1~8	

! When ISP mode is enabled, watchdog will be disabled by hardware.

Register::WDT_test		0xFFEB			
Name	Bits	R/W	Default	Comments	Config
Reserved	7:2	--	--	Reserved	
BY_CNT2	1	R/W	0	Signal bypass counter2 0: signal pass through counter2 1: bypass	
BY_CNT3	0	R/W	0	Signal bypass counter3 0: signal pass through counter3 1: bypass	

In System Programming

User can program the external serial FLASH by internal hardware without removing serial FLASH from the system. RTD2662 utilizes DDC channel (ADC/DDC2/DDC3) to communicate with IIC host for ISP function. The ISP protocol is mainly compatible with DDC protocol. However, one significant difference is that the LSB of 7-bit ISP address is the address auto increase bit. Thus, we can improve the flash program speed.

Register::ISP_slave_address		0xFFEC			
Name	Bits	R/W	Default	Comments	Config
ISP_ADDR	7:2	R/W	25	ISP slave address	
ISP_ADDR_INC_A	1	R	0	Received LSB of ISP slave address of ADC DDC channel 0: address is nonincrease 1: address is auto-increase	
ISP_ADDR_INC_D	0	R	0	Received LSB of ISP slave address of DDC2 channel 0: address is nonincrease 1: address is auto-increase	

Register::MCU_control		0xFFED			
Name	Bits	R/W	Default	Comments	Config
PORT_PIN_REG	7	R/W	1	port_pin_reg_n enable 0: port_pin_reg_n signal is disabled 1: port_pin_reg_n signal is enabled	
ISP_ADDR_INC_H	6	R	0	Received LSB of ISP slave address of DDC3 channel 0: address is nonincrease 1: address is auto-increase	
FLASH_CLK_DIV	5:2	R/W	2	SPI-FLASH clock divider, its clock source is selected by MCU_CLK_SEL, default is MCU_CLK_SEL/2	

MCU_CLK_SEL	1	R/W	0	CPU clock source select 0: CPU clock is from Crystal divided by DIV 1: CPU clock is from PLL divided by DIV	
CKOUT_SEL	0	R/W	0	CLKO1 & CLKO2 select 0: Select Crystal output 1: Select Mcu clk output	

Register::MCU_clock_control		0xFFEE			
Name	Bits	R/W	Default	Comments	Config
Reserved	7	--	--	Reserved	
MCU_PERL_NON_STOP	6	R/W	0	1: keep mcu peripheral running whiel mcu stopped by spi flash access 0: peripheral will be stopped with mcu*.	
MCU_CLK_DIV	5:2	R/W	1	MCU clock is FLASH clock/MCU_CLK_DIV.	
SOF_RST	1	R/W	0	Software reset mcu 0: No effect 1: reset RTD2662	Rport Wport
SCA_HRST	0	R/W	0	Hardware reset for Scalar 0: No effect 1: reset SCALAR module	

*note: this register bit[6] only has effect on peripheral built in SFR, which are timer 0, 1, 2 and serial port 1.

Register::RAM_test		0xFFEF			
Name	Bits	R/W	Default	Comments	Config
reserved	7:5	--	0	Reserved	
Test_mode	4	R/W	0	When test_mode of scalar is enabled for embedded mcu output, the bus is decided by following settins. 0: adca_out[5:0], adca_out_valid, adca_ckini, adcb_out[9:0], adcb_out_valid,	

				adcb_ckini, flash_mcu_gated, bist_clk, xram_clk, adc_div270_clk, adc_div9_clk, eclk_ng, eclk_n, eclk, shift_in_clk, fclk 1: 13'b0, st_cmd [2:0], st_ph [3:0], find_d01_value, find_d01, find_rpt., find_str, st_data, st_lead, st_search, rmtin, remote_in2, irin	
EXT_RAM_BIST	3	R/W	0	Start BIST function for MCU external RAM (1024 bytes) 0: finished and clear 1: start	Rport Wport
EXT_RAM_STA	2	R	0	Test result about MCU external RAM 0: fail 1: ok	
INT_RAM_BIST	1	R/W	0	Start BIST function for MCU internal RAM (256 bytes) 0: finished and clear 1: start	Rport Wport
INT_RAM_STA	0	R	0	Test result about MCU internal RAM 0: fail 1: ok	

Register:: REV_DUMMY6						0xFFF2	
Name	Bits	R/W	Default	Comments	Config		
REV_DUMMY6	7:0	R/W	00	Dummy6			

Scalar Interface

Scalar Interface Related Register

External host interface is selected by power-on latch. The internal XFR access will be auto-switched to external host interface by power-on latch, too.

Scalar's register map must reserve addresses for mapping necessary XFR when using external host interface.

Register:: SCA_INF_CONTROL						0xFFFF3	
Name	Bits	R/W	Default	Comments	Config		
REG_READ_EN	7	R	0	Enable Read Action of Scalar Interface			
REG_WRITE_EN	6	R	0	Enable Write Action of Scalar Interface			
ADDR_NON_INC	5	R/W	0	1: turn-off address auto inc			
REG_BURCMD_WR	4	R/W	0	Enable burst write function, mcu will halt till action done or an interrupt triggered. *	Rport Wport		
REG_BURDAT_WR	3	R/W	0	Enable burst write data to HOST_ADDR, mcu will halt till action done or an interrupt triggered *	Rport Wport		
BURST_CMD_ERR	2	R	0	Burst write command error, value of SCA_INF_BWR_COUNT mismatch the length in content			
DIS_INT_RLS	1	R/W	0	1: disable the function of releasing mcu by interrupt			
PAGE_ADDR_MAP	0	R/W	0	0: Using normal XFR address to access all XFR 1: Using external page address for XFR. XFR can only be accessed by SCA_INF_ADDR, SCA_INF_DATA			

*: MCU will be released when interrupt is triggered. The bit value will maintain 1 before the operation is done. Rewriting this bit to 1 to continue the burst cmd/data write mode.

Register:: SCA_INF_ADDR						0xFFFF4	
Name	Bits	R/W	Default	Comments	Config		
HOST_ADDR	7:0	R/W	0x00	Host Interface Access Address	Rport Wport		

Register:: SCA_INF_DATA						0xFFFF5	
Name	Bits	R/W	Default	Comments	Config		
HOST_DATA	7:0	R/W	0x00	Host Interface Access Data In/Out Continuously R/W with/without address auto-increment depends on ADDR_NON_INC	Rport Wport		

Register:: SCA_INF_BWR_ADRH						0xFFFF6	
Name	Bits	R/W	Default	Comments	Config		
BWR_ADRH	7:0	R/W	0x00	Burst Write Command Start Address [23:16]	Rport Wport		

Register:: SCA_INF_BWR_ADRM						0xFFFF7	
Name	Bits	R/W	Default	Comments	Config		
BWR_ADRM	7:0	R/W	0x00	Burst Write Command Start Address [15:8]	Rport Wport		

Register:: SCA_INF_BWR_ADRL					0xFFF8	
Name	Bits	R/W	Default	Comments	Config	
BWR_ADRL	7:0	R/W	0x00	Burst Write Command Start Address [7:0]	Rport Wport	

Register:: SCA_INF_BWR_COUNT_H					0xFFF9	
Name	Bits	R/W	Default	Comments	Config	
BWR_BYTE_COUNT_H	7:0	R/W	0x00	Burst Write Command Data Length. Left byte count when interrupt is asserted	Rport Wport	

Register:: SCA_INF_BWR_COUNT_L					0xFFFA	
Name	Bits	R/W	Default	Comments	Config	
BWR_BYTE_COUNT_L	7:0	R/W	0x00	Burst Write Command Data Length, left byte count when interrupt is asserted	Rport Wport	

Register:: SCA_INF_PERIOD					0xFFFB	
Name	Bits	R/W	Default	Comments	Config	
SCA_INF_PERIOD	7:0	R/W	0x00	Interval Between Two Command TI = SYS_PERIOD * 2 * BWR_PERIOD, it will halt mcu extra time TI in normal access and maintain the interval TI between two access in burst write mode.		

*For 50MHz system clock, BWR_PERIOD can be delayed to 10.2us > 10us for special requirement of OSD register

Table Format for register burst write command format

```

BYTE code tFONT_GLOBAL[] = {
Length_A, AUTOINC_A, ADDR_A, DATA_A0, DATA_A1.....,
Length_B, AUTOINC_B, ADDR_B, DATA_B0, DATA_B1.....,
.....,
_END
0x4 , 0x0, 0xA0, 01
0x6, 0x0, 0x90, 0x01, 0x02, 0x03
.....,
0x0
}
    
```

note: AUTOINC = 0 means enable address auto-increment

Example for firmware reference:

1. OSD font table

```
// set initial address of data = 0x102030
BWR_ADRH = 0x10
BWR_ADRM = 0x20
BWR_ADRL = 0x30

// set data byte count = 0x0890
BWR_BYTE_COUNT_H = 0x08
BWR_BYTE_COUNT_L = 0x90

// set scalar's target register address = 0x58
SCA_INF_ADDR = 0x58

// enable burst data write
SCA_INF_CONTROL[3] = 1'b1
```

2. Command table

```
// set initial address of data = 0x102030
BWR_ADRH = 0x10
BWR_ADRM = 0x20
BWR_ADRL = 0x30

// set data byte count = 0x0890
BWR_BYTE_COUNT_H = 0x08
BWR_BYTE_COUNT_L = 0x90

// enable burst command write
SCA_INF_CONTROL[4] = 1'b1
```

Bank Switch

Due to only one external SPI-FLASH is used for embedded MCU, it is necessary to allocate the non-volatile memory for both program code and external data (XDATA). In default, the 0x0 ~ 0xFFFF is used for program code, and the 0x10000 ~ 0x1FFFF is used for external data. When 64K-byte FLASH is used, there is no space in FLASH reserved for XDATA. XRAM and XFR are still accessible. More than 64K-byte FLASH can be used by designer's plan. GPIO mode for bank switch is used for 128K-byte FLASH and up to 256x64K bytes FLASH is supported by XFR mode. Both of them are supported by KeilC. The start bank of XDATA is defined by XDATA_BSTART. XRAM is allocated to 0xFB00 – 0xFEFF of XDATA's Bank0. Besides, except XFR address 0xFFFE and 0xFFFF, XFR and XRAM can be chosen if occupy only one bank of XDATA. Designer can set program address to include the whole FLASH address space without using the

range reserved for XDATA to avoid partitioning the boundary in the power of 2. The following table is an example. Program is designed to use only 0x00000 – 0x4FFF, but declare a 0x00000 – 0x7FFFF address space. Bank 5 ~ Bank 7 of program code will be empty and not programmed into FLASH. XDATA is allocated in 0x50000 – 0x7FFFF via setting of XFR.

SPI FLASH Address	Program Address	Xdata	XRAM	XFR
00000-0FFFF	Bank0, 0000-FFFF			
10000-1FFFF	Bank1, 0000-FFFF			
20000-2FFFF	Bank2, 0000-FFFF			
30000-3FFFF	Bank3, 0000-FFFF			
40000-4FFFF	Bank4, 0000-FFFF			
50000-5FFFF	Bank5, 0000-FFFF	Bank0, 0000-FFFF	FB00 - FEFF	FF00-FFFF
60000-6FFFF	Bank6, 0000-FFFF	Bank1, 0000-FFFF		FF00-FFFF
70000-7FFFF	Bank7, 0000-FFFF	Bank2, 0001-FFFF		FF00-FFFF

Register::Bank_swich_control				0xFFFC	
Name	Bits	R/W	Default	Comments	Config
Reserved	7:4	--	0	Reserved	
GLOBAL_XFR	3	R/W	1	1: XFR will occupy the address space of all XDATA banks. 0: only 0xFFFF will occupy the address of all XDATA banks.	
GLOBAL_XRAM	2	R/W	0	1: XRAM will occupy the address space of all XDATA banks. 0: XRAM only occupy XDATA bank 0	
SW_MODE	1	R/W	0	0: using P3.5 as A16 1: using Pbank_switch (0xFFFF)	
BANK_EN	0	R/W	0	1: Enable Bank Switching Function for program address space 0: Disable Bank Switching, program memory space is 64K byte and GLOBAL_XFR, GLOBAL_XRAM, XDATA_BSTART, XDATA_BSEL still can be used to control XDATA memory space.	

Register::XDATA_bank_start 0xFFFD					
Name	Bits	R/W	Default	Comments	Config
XDATA_BSTART	7:0	R/W	0x1	The start bank number for XDATA access.	

Register::XDATA_bank_sel 0xFFFE					
Name	Bits	R/W	Default	Comments	Config
XDATA_BSEL	7:0	R/W	0	First bank number for XDATA access.	

Register::Pbank_switch 0xFFFF					
Name	Bits	R/W	Default	Comments	Config
PBANK_SEL	7:0	R/W	0	Bank number for program code access.	

Embedded OSD

Addressing and Accessing Register

ADDRESS	BIT							
	7	6	5	4	3	2	1	0
High Byte	A15	A14	A13	A12	A11	A10	A9	A8
Low Byte	A7	A6	A5	A4	A3	A2	A1	A0

Figure 2. Addressing and Accessing Registers

Date	BIT							
Byte 0	D7	D6	D5	D4	D3	D2	D1	D0
Byte 1	D7	D6	D5	D4	D3	D2	D1	D0
Byte 2	D7	D6	D5	D4	D3	D2	D1	D0

Figure 2. Data Registers

All kind of registers can be controlled and accessed by these 2 bytes, and each address contains 3-byte data, details are described as follows:

Write mode: [A15:A14] select which byte to write

-00: Byte 0 -01:Byte 1 -10: Byte 2 -11: All

**All data are sorted by these three Bytes (Byte0~Byte2)*

[A13] Auto Load (Double Buffer)

[A12] Address indicator

-0: Window and frame control registers.

-1: Font Select and font map SRAM

[A11:A0] Address mapping

- Font Select and font map SRAM address: 000~EFF **3.75k*3byte**

-Frame control register address: 000~0xx (**Latch**)

-Window control register address: 100~1xx (**Latch**)

** Selection of SRAM address or Latch address selection is determined by A12!*

Example:

Bit [15:14]=00

-All data followed are written to byte0 and address increases.

Byte0 → Byte0 → Byte0... (Address will auto increase)

Bit [15:14] =01

-All data followed are written to byte1 and address increases.

Byte1 → Byte1 → Byte1... (Address will auto increase)

Bit [15:14] =11

- Address will be increased after each 3-byte data written.

Byte0 → Byte1 → Byte2 → Byte0 → Byte1 → Byte2... (Address will auto increase)

Window control registers

- l Windows all support shadow/border/3D button
- l Window0, 5, 6, 7 support gradient functions.
- l Window 4, 5, 6, 7 start/end resolution are 1line(pixel), Window 0, 1, 2, 3 start/end resolution are 4line(pixel),
- l All window start and end position include the **special effect (border/shadow/3D button)** been assigned
- l Font comes after windows by 10 pixels, so you should compensate 10 pixels on windows to meet font position

Window 0 Shadow/Border/Gradient

Address: 100h

Byte 0

Bit	Mode	Function
7:6	--	Reserved
5:3	W	Window 0 shadow/border width or 3D button thickness in pixel unit 000~111: 1 ~ 8 pixel
2:0	W	Window 0 shadow/border height in line unit 000~111: 1 ~ 8 line It must be the same as bit[5:3] for 3D button thickness

Byte 1

Bit	Mode	Function
7:4	W	Window 0 shadow color index in 16-color LUT For 3D window, it is the left-top/bottom border color

3:0	W	Window 0 border color index in 16-color LUT For 3D window, it is the right-bottom/top border color
-----	---	---

Byte 2

Bit	Mode	Function
7	W	R Gradient Polarity 0: Decrease 1: Increase
6	W	G Gradient Polarity 0: Decrease 1: Increase
5	W	B Gradient Polarity 0: Decrease 1: Increase
4:3	W	Gradient level 00: 1 step per level 01: Repeat 2 step per level 10: Repeat 3 step per level 11: Repeat 4 step per level
2	W	Enable Red Color Gradient
1	W	Enable Green Color Gradient
0	W	Enable Blue Color Gradient

Window 0 start position
Address: 101h

Byte 0

Bit	Mode	Function
7:2	W	Window 0 horizontal start [5:0]
1:0	--	Reserved

Byte 1

Bit	Mode	Function
7:5	W	Window 0 vertical start [2:0] line
4:0	W	Window 0 horizontal start [10:6] pixel

Byte 2

Bit	Mode	Function
7:0	W	Window 0 vertical start [10:3] line

Start position must be increments of four.

Window 0 end position
Address: 102h

Byte 0

Bit	Mode	Function
7:2	W	Window 0 horizontal end [5:0]
1:0	--	Reserved

Byte 1

Bit	Mode	Function
7:5	W	Window 0 vertical end [2:0] line
4:0	W	Window 0 horizontal end [10:6] pixel

Byte 2

Bit	Mode	Function
7:0	W	Window 0 vertical end [10:3] line

End position must be increments of four.

Window 0 control
Address: 103h

Byte 0

Bit	Mode	Function
7:0	--	Reserved

Byte 1

Bit	Mode	Function
7	--	Reserved

6:4	W	111: 7 level per gradient 110: 6 level per gradient 101: 5 level per gradient 100: 4 level per gradient 011: 3 level per gradient 010: 2 level per gradient 001: 1 level per gradient 000: 8 level per gradient
3:0	W	Window 0 color index in 16-color LUT

Byte 2

default: 00h

Bit	Mode	Function
7	W	Reserved
6	W	Gradient function 0: Disable 1: Enable
5	W	Gradient direction 0: Horizontal 1: Vertical
4	W	Shadow/Border/3D button 0: Disable 1: Enable
3:1	W	Window 0 Type 000: Shadow Type 1 001: Shadow Type 2 010: Shadow Type3 011: Shadow Type 4 100: 3D Button Type 1 101: 3D Button Type 2 110: Reserved 111: Border
0	W	Window 0 Enable 0: Disable 1: Enable

Window 1 Shadow/Border/Gradient
Address: 104h

Byte 0

Bit	Mode	Function
7:6	W	Reserved
5:3	W	Window 1 shadow/border width or 3D button thickness in pixel unit 000~111: 1 ~ 8 pixel
2:0	W	Window 1 shadow/border height in line unit 000~111: 1 ~ 8 line It must be the same as bit[5:3] for 3D button thickness

Byte 1

Bit	Mode	Function
7:4	W	Window 1 shadow color index in 16-color LUT For 3D window, it is the left-top/bottom border color
3:0	W	Window 1 border color index in 16-color LUT For 3D window, it is the right-bottom/top border color

Byte 2

Bit	Mode	Function
7:0	W	Reserved

Window 1 start position
Address: 105h

Byte 0

Bit	Mode	Function
7:2	W	Window 1 horizontal start [5:0]
1:0	--	Reserved

Byte 1

Bit	Mode	Function
7:5	W	Window 1 vertical start [2:0] line
4:0	W	Window 1 horizontal start [10:6] pixel

Byte 2

Bit	Mode	Function
7:0	W	Window 1 vertical start [10:3] line

Start position must be increments of four.

Window 1 end position

Address: 106h

Byte 0

Bit	Mode	Function
7:2	W	Window 1 horizontal end [5:0]
1:0	--	Reserved

Byte 1

Bit	Mode	Function
7:5	W	Window 1 vertical end [2:0] line
4:0	W	Window 1 horizontal end [10:6] pixel

Byte 2

Bit	Mode	Function
7:0	W	Window 1 vertical end [10:3] line

End position must be increments of four.

Realtek Confidential for GM Only

Window 1 control
Address: 107h

Byte 0

Bit	Mode	Function
7:0	--	Reserved

Byte 1

Bit	Mode	Function
7:4	--	Reserved
3:0	W	Window 1 color index in 16-color LUT

Byte 2

default: 00h

Bit	Mode	Function
7:5	W	Reserved
4	W	Shadow/Border/3D button 0: Disable 1: Enable
3:1	W	Window 1 Type 000: Shadow Type 1 001: Shadow Type 2 010: Shadow Type3 011: Shadow Type 4 100: 3D Button Type 1 101: 3D Button Type 2 110: Reserved 111: Border
0	W	Window 1 Enable 0: Disable 1: Enable

Window 2 Shadow/Border/Gradient
Address: 108h

Byte 0

Bit	Mode	Function
7:6	W	Reserved
5:3	W	Window 2 shadow/border width or 3D button thickness in pixel unit 000~111: 1 ~ 8 pixel
2:0	W	Window 2 shadow/border height in line unit 000~111: 1 ~ 8 line

		It must be the same as bit[5:3] for 3D button thickness
--	--	---

Byte 1

Bit	Mode	Function
7:4	W	Window 2 shadow color index in 16-color LUT For 3D window, it is the left-top/bottom border color
3:0	W	Window 2 border color index in 16-color LUT For 3D window, it is the right-bottom/top border color

Byte 2

Bit	Mode	Function
7:0	W	Reserved

Window 2 start position
Address: 109h

Byte 0

Bit	Mode	Function
7:2	W	Window 2 horizontal start [5:0]
1:0	--	Reserved

Byte 1

Bit	Mode	Function
7:5	W	Window 2 vertical start [2:0] line
4:0	W	Window 2 horizontal start [10:6] pixel

Byte 2

Bit	Mode	Function
7:0	W	Window 2 vertical start [10:3] line

Start position must be increments of four.

Window 2 end position
Address: 10Ah

Byte 0

Bit	Mode	Function
7:2	W	Window 2 horizontal end [5:0]
1:0	--	Reserved

Byte 1

Bit	Mode	Function
7:5	W	Window 2 vertical end [2:0] line
4:0	W	Window 2 horizontal end [10:6] pixel

Byte 2

Bit	Mode	Function
7:0	W	Window 2 vertical end [10:3] line

End position must be increments of four.

Window 2 control

Address: 10Bh

Byte 0

Bit	Mode	Function
7:0	--	Reserved

Byte 1

Bit	Mode	Function
7:4	--	Reserved
3:0	W	Window 2 color index in 16-color LUT

Byte 2

default: 00h

Bit	Mode	Function
7:5	W	Reserved
4	W	Shadow/Border/3D button 0: Disable 1: Enable
3:1	W	Window 2 Type 000: Shadow Type 1 001: Shadow Type 2 010: Shadow Type3 011: Shadow Type 4 100: 3D Button Type 1 101: 3D Button Type 2 110: Reserved 111: Border
0	W	Window 2 Enable 0: Disable 1: Enable

Window 3 Shadow/Border/Gradient

Address: 10Ch

Byte 0

Bit	Mode	Function
7:6	W	Reserved
5:3	W	Window 3 shadow/border width or 3D button thickness in pixel unit

		000~111: 1 ~ 8 pixel
2:0	W	Window 3 shadow/border height in line unit 000~111: 1 ~ 8 line It must be the same as bit[5:3] for 3D button thickness

Byte 1

Bit	Mode	Function
7:4	W	Window 3 shadow color index in 16-color LUT For 3D window, it is the left-top/bottom border color
3:0	W	Window 3 border color index in 16-color LUT For 3D window, it is the right-bottom/top border color

Byte 2

Bit	Mode	Function
7:0	W	Reserved

Window 3 start position
Address: 10Dh

Byte 0

Bit	Mode	Function
7:2	W	Window 3 horizontal start [5:0]
1:0	--	Reserved

Byte 1

Bit	Mode	Function
7:5	W	Window 3 vertical start [2:0] line
4:0	W	Window 3 horizontal start [10:6] pixel

Byte 2

Bit	Mode	Function
7:0	W	Window 3 vertical start [10:3] line

Start position must be increments of four.

Window 3 end position
Address: 10Eh

Byte 0

Bit	Mode	Function
7:2	W	Window 3 horizontal end [5:0]
1:0	--	Reserved

Byte 1

Bit	Mode	Function
7:5	W	Window 3 vertical end [2:0] line

4:0	W	Window 3 horizontal end [10:6] pixel
-----	---	--------------------------------------

Byte 2

Bit	Mode	Function
7:0	W	Window 3 vertical end [10:3] line

End position must be increments of four.

Window 3 control
Address: 10Fh

Byte 0

Bit	Mode	Function
7:0	--	Reserved

Byte 1

Bit	Mode	Function
7:4	--	Reserved
3:0	W	Window 3 color index in 16-color LUT

Byte 2

default: 00h

Bit	Mode	Function
7:5	W	Reserved
4	W	Shadow/Border/3D button 0: Disable 1: Enable
3:1	W	Window 3 Type 000: Shadow Type 1 001: Shadow Type 2 010: Shadow Type3 011: Shadow Type 4 100: 3D Button Type 1 101: 3D Button Type 2 110: Reserved 111: Border
0	W	Window 3 Enable 0: Disable 1: Enable

Window 4 Shadow/Border/Gradient
Address: 110h

Byte 0

Bit	Mode	Function
7:6	W	Reserved
5:3	W	Window 4 shadow/border width or 3D button thickness in pixel unit 000~111: 1 ~ 8 pixel
2:0	W	Window 4 shadow/border height in line unit 000~111: 1 ~ 8 line It must be the same as bit[5:3] for 3D button thickness

Byte 1

Bit	Mode	Function
7:4	W	Window 4 shadow color index in 16-color LUT For 3D window, it is the left-top/ bottom border color
3:0	W	Window 4 border color index in 16-color LUT For 3D window, it is the right-bottom/top border color

Byte 2

Bit	Mode	Function
7:0	W	Reserved

Window 4 start position
Address: 111h

Byte 0

Bit	Mode	Function
7:2	W	Window 4 horizontal start [5:0]
2:0	--	Reserved

Byte 1

Bit	Mode	Function
7:5	W	Window 4 vertical start [2:0] line
4:0	W	Window 4 horizontal start [10:6] pixel

Byte 2

Bit	Mode	Function
7:0	W	Window 4 vertical start [10:3] line

Window 4 end position
Address: 112h

Byte 0

Bit	Mode	Function
7:2	W	Window 4 horizontal end [5:0]
1:0	--	Reserved

Byte 1

Bit	Mode	Function
7:5	W	Window 4 vertical end [2:0] line
4:0	W	Window 4 horizontal end [10:6] pixel

Byte 2

Bit	Mode	Function
7:0	W	Window 4 vertical end [10:3] line

Window 4 control
Address: 113h

Byte 0

Bit	Mode	Function
7:0	--	Reserved

Byte 1

Bit	Mode	Function
7:4	--	Reserved
3:0	W	Window 4 color index in 16-color LUT

Byte 2

default: 00h

Bit	Mode	Function
7:5	W	Reserved
4	W	Shadow/Border/3D button 0: Disable 1: Enable
3:1	W	Window 4 Type 000: Shadow Type 1 001: Shadow Type 2 010: Shadow Type3 011: Shadow Type 4 100: 3D Button Type 1 101: 3D Button Type 2 110: Reserved 111: Border
0	W	Window 4 Enable 0: Disable 1: Enable

Window 5 Shadow/Border/Gradient
Address: 114h

Byte 0

Bit	Mode	Function
7:6	W	Reserved
5:3	W	Window 5 shadow/border width or 3D button thickness in pixel unit 000~111: 1 ~ 8 pixel
2:0	W	Window 5 shadow/border height in line unit 000~111: 1 ~ 8 line It must be the same as bit[5:3] for 3D button thickness

Byte 1

Bit	Mode	Function
7:4	W	Window 5 shadow color index in 16-color LUT For 3D window, it is the left-top/bottom border color
3:0	W	Window 5 border color index in 16-color LUT For 3D window, it is the right-bottom/top border color

Byte 2

Bit	Mode	Function
7	W	R Gradient Polarity 0: Decrease 1: Increase
6	W	G Gradient Polarity 0: Decrease 1: Increase
5	W	B Gradient Polarity 0: Decrease 1: Increase
4:3	W	Gradient level 00: 1 step per level 01: Repeat 2 step per level 10: Repeat 3 step per level 11: Repeat 4 step per level
2	W	Enable Red Color Gradient
1	W	Enable Green Color Gradient
0	W	Enable Blue Color Gradient

Window 5 start position
Address: 115h
Byte 0

Bit	Mode	Function
-----	------	----------

7:2	W	Window 5 horizontal start [5:0]
1:0	--	Reserved

Byte 1

Bit	Mode	Function
7:5	W	Window 5 vertical start [2:0] line
4:0	W	Window 5 horizontal start [10:6] pixel

Byte 2

Bit	Mode	Function
7:0	W	Window 5 vertical start [10:3] line

Window 5 end position
Address: 116h

Byte 0

Bit	Mode	Function
7:2	W	Window 5 horizontal end [5:0]
1:0	--	Reserved

Byte 1

Bit	Mode	Function
7:5	W	Window 5 vertical end [2:0] line
4:0	W	Window 5 horizontal end [10:6] pixel

Byte 2

Bit	Mode	Function
7:0	W	Window 5 vertical end [10:3] line

Window 5 control
Address: 117h

Byte 0

Bit	Mode	Function
7:0	--	Reserved

Byte 1

Bit	Mode	Function
7	--	Reserved
6:4	W	111: 7 level per gradient 110: 6 level per gradient 101: 5 level per gradient 100: 4 level per gradient 011: 3 level per gradient 010: 2 level per gradient

		001: 1 level per gradient 000: 8 level per gradient
3:0	W	Window 5 color index in 16-color LUT

Byte 2

default: 00h

Bit	Mode	Function
7	W	Reserved
6	W	Gradient function 0: Disable 1: Enable
5	W	Gradient direction 0: Horizontal 1: Vertical
4	W	Shadow/Border/3D button 0: Disable 1: Enable
3:1	W	Window 5 Type 000: Shadow Type 1 001: Shadow Type 2 010: Shadow Type3 011: Shadow Type 4 100: 3D Button Type 1 101: 3D Button Type 2 110: Reserved 111: Border
0	W	Window 5 Enable 0: Disable 1: Enable

Window 6 Shadow/Border/Gradient
Address: 118h

Byte 0

Bit	Mode	Function
7:6	W	Reserved
5:3	W	Window 6 shadow/border width or 3D button thickness in pixel unit 000~111: 1 ~ 8 pixel

2:0	W	Window 6 shadow/border height in line unit 000~111: 1 ~ 8 line It must be the same as bit[5:3] for 3D button thickness
-----	---	--

PS: This is for non-rotary, rotate 270, rotate 90 and 180.

Byte 1

Bit	Mode	Function
7:4	W	Window 6 shadow color index in 16-color LUT For 3D window, it is the left-top/ bottom border color
3:0	W	Window 6 border color index in 16-color LUT For 3D window, it is the right-bottom/top border color

Byte 2

Bit	Mode	Function
7	W	R Gradient Polarity 0: Decrease 1: Increase
6	W	G Gradient Polarity 0: Decrease 1: Increase
5	W	B Gradient Polarity 0: Decrease 1: Increase
4:3	W	Gradient level 00: 1 step per level 01: Repeat 2 step per level 10: Repeat 3 step per level 11: Repeat 4 step per level
2	W	Enable Red Color Gradient
1	W	Enable Green Color Gradient
0	W	Enable Blue Color Gradient

Window 6 start position

Address: 119h

Byte 0

Bit	Mode	Function
7:2	W	Window 6 horizontal start [5:0]
1:0	--	Reserved

Byte 1

Bit	Mode	Function
7:5	W	Window 6 vertical start [2:0] line
4:0	W	Window 6 horizontal start [10:6] pixel

Byte 2

Bit	Mode	Function
7:0	W	Window 6 vertical start [10:3] line

Window 6 end position
Address: 11Ah

Byte 0

Bit	Mode	Function
7:2	W	Window 6 horizontal end [5:0]
1:0	--	Reserved

Byte 1

Bit	Mode	Function
7:5	W	Window 6 vertical end [2:0] line
4:0	W	Window 6 horizontal end [10:6] pixel

Byte 2

Bit	Mode	Function
7:0	W	Window 6 vertical end [10:3] line

Window 6 control
Address: 11Bh

Byte 0

Bit	Mode	Function
7:0	--	Reserved

Byte 1

Bit	Mode	Function
7	--	Reserved
6:4	W	111: 7 level per gradient 110: 6 level per gradient 101: 5 level per gradient 100: 4 level per gradient 011: 3 level per gradient 010: 2 level per gradient 001: 1 level per gradient 000: 8 level per gradient

3:0	W	Window 6 color index in 16-color LUT
Byte 2		default: 00h
Bit	Mode	Function
7	W	Reserved
6	W	Gradient function 0: Disable 1: Enable
5	W	Gradient direction 0: Horizontal 1: Vertical
4	W	Shadow/Border/3D button 0: Disable 1: Enable
3:1	W	Window 6 Type 000: Shadow Type 1 001: Shadow Type 2 010: Shadow Type3 011: Shadow Type 4 100: 3D Button Type 1 101: 3D Button Type 2 110: Reserved 111: Border
0	W	Window 6 Enable 0: Disable 1: Enable

Window 7 Shadow/Border/Gradient
Address: 11Ch

Byte 0

Bit	Mode	Function
7:6	W	Reserved
5:3	W	Window 7 shadow/border width or 3D button thickness in pixel unit 000~111: 1 ~ 8 pixel
2:0	W	Window 7 shadow/border height in line unit 000~111: 1 ~ 8 line It must be the same as bit[5:3] for 3D button thickness

PS: This is for non-rotary, rotate 270, rotate 90 and 180.

Byte 1

Bit	Mode	Function
7:4	W	Window 7 shadow color index in 16-color LUT For 3D window, it is the left-top/bottom border color
3:0	W	Window 7 border color index in 16-color LUT For 3D window, it is the right-bottom/top border color

Byte 2

Bit	Mode	Function
7	W	R Gradient Polarity 0: Decrease 1: Increase
6	W	G Gradient Polarity 0: Decrease 1: Increase
5	W	B Gradient Polarity 0: Decrease 1: Increase
4:3	W	Gradient level 00: 1 step per level 01: Repeat 2 step per level 10: Repeat 3 step per level 11: Repeat 4 step per level
2	W	Enable Red Color Gradient
1	W	Enable Green Color Gradient
0	W	Enable Blue Color Gradient

Window 7 start position
Address: 11Dh

Byte 0

Bit	Mode	Function
7:2	W	Window 7 horizontal start [5:0]
1:0	--	Reserved

Byte 1

Bit	Mode	Function
7:5	W	Window 7 vertical start [2:0] line
4:0	W	Window 7 horizontal start [10:6] pixel

Byte 2

Bit	Mode	Function
7:0	W	Window 7 vertical start [10:3] line

Window 7 end position
Address: 11Eh

Byte 0

Bit	Mode	Function
7:2	W	Window 7 horizontal end [5:0]
1:0	--	Reserved

Byte 1

Bit	Mode	Function
7:5	W	Window 7 vertical end [2:0] line
4:0	W	Window 7 horizontal end [10:6] pixel

Byte 2

Bit	Mode	Function
7:0	W	Window 7 vertical end [10:3] line

Window 7 control
Address: 11Fh

Byte 0

Bit	Mode	Function
7:0	--	Reserved

Byte 1

Bit	Mode	Function
7	--	Reserved
6:4	W	111: 7 level per gradient 110: 6 level per gradient 101: 5 level per gradient 100: 4 level per gradient 011: 3 level per gradient 010: 2 level per gradient 001: 1 level per gradient 000: 8 level per gradient
3:0	W	Window 7 color index in 16-color LUT

Byte 2

default: 00h

Bit	Mode	Function
7	W	Reserved
6	W	Gradient function

		0: Disable 1: Enable
5	W	Gradient direction 0: Horizontal 1: Vertical
4	W	Shadow/Border/3D button 0: Disable 1: Enable
3:1	W	Window 7 Type 000: Shadow Type 1 001: Shadow Type 2 010: Shadow Type3 011: Shadow Type 4 100: 3D Button Type 1 101: 3D Button Type 2 110: Reserved 111: Border
0	W	Window 7 Enable 0: Disable 1: Enable

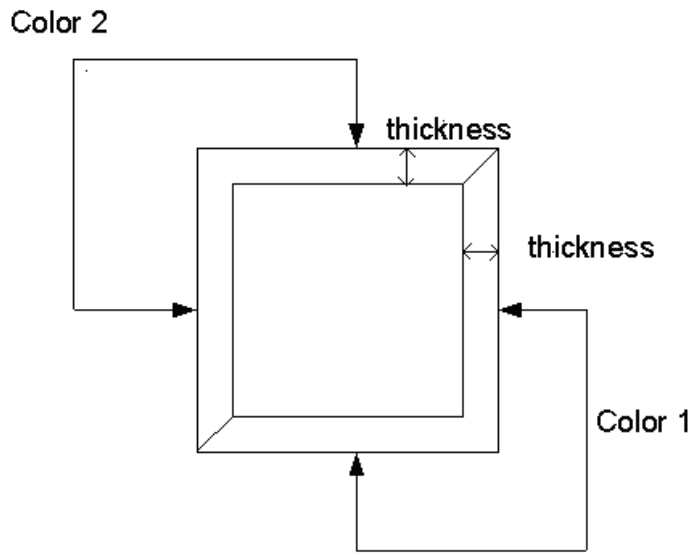

3D Button Type 1

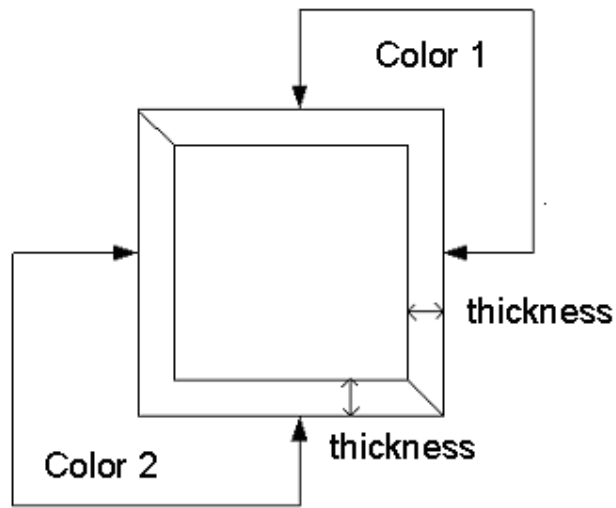

3D Button Type 2

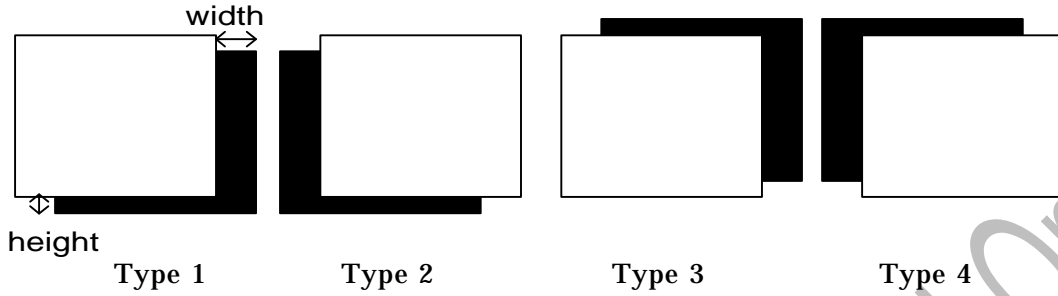

Shadow in all direction

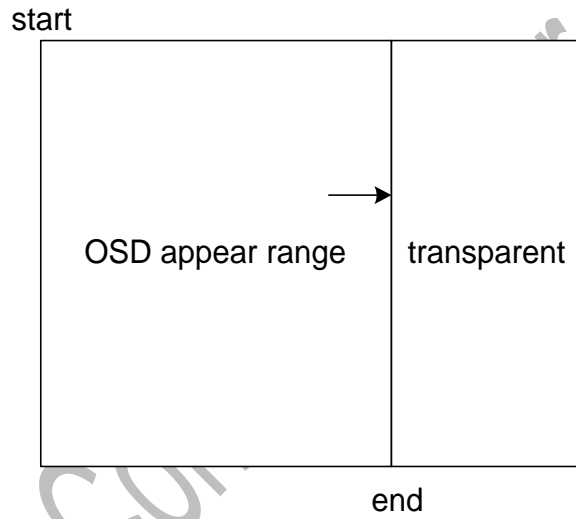

Window mask fade/in out function

Frame control registers
Address: 000h

Byte 0

Bit	Mode	Function
7:0	R/W	Vertical Delay [10:3] The bits define the vertical starting address. Total 2048 step unit: 1 line

Vertical delay minimum should set 1

Byte 1

Bit	Mode	Function
7:0	R/W	Horizontal Delay [9:2] The bits define the horizontal starting address. Total 1024 step unit:4 pixels

Horizontal delay minimum should set 2

Byte 2

default: xxxx_xxx0b

Bit	Mode	Function
7:6	R/W	Horizontal Delay bit [1:0]
5:3	R/W	Vertical Delay [2:0]
2:1	R/W	Display zone, for smaller character width 00: middle 01: left 10: right 11: reserved
0	R/W	OSD enable 0: OSD circuit is inactivated 1: OSD circuit is activated

- ! When OSD is disabled, Double Width (address 0x002 Byte1[1]) must be disabled to save power.
- ! These three bytes have their own double-buffer.

Address 001h ~ Address002h are reserved

Address: 003h

Byte 0

Default: 00h

Bit	Mode	Function
7	R/W	Specific color blending (blending type 2) 0: Disable 1: Enable
6:5	R/W	Window 7special function 00: disable 01: blending (blending type 3) 10: window 7 mask region appear 11: window 7 mask region transparent
4	R/W	OSD vertical start input signal source select 0: Select DVS as OSD VSYNC input 1: Select ENA as OSD VSYNC input
3:0	R/W	Blending color from 16-color LUT (blending type 2)

Byte 1

Default: 00h

Bit	Mode	Function
7:4	R/W	Char shadow/border color
3: 2	R/W	Alpha blending type (blending type 1) 00: Disable alpha blending 01: Only window blending 10: All blending 11: Window and Character background blending
1	R/W	Double width enable (For all OSD including windows and characters) 0: Normal 1: Double
0	R/W	Double Height enable (For all OSD including windows and characters) 0: Normal 1: Double

Total blending area = blending type1 area + blending type 2 area + blending type 3 area

Byte 2

Default: 00h

Bit	Mode	Function
7:6	R/W	Font downloaded swap control 0x: No swap

		10: CCW 11: CW
5	R	Buffer Empty 0: Empty 1: Not Empty
4	R	Buffer Valid 0: Done 1: Buffer is writing to SDRAM
3	R/W	Reset Buffer Write 1 to reset and auto-clear after finished.
2	R/W	Hardware Rotation Enable 0: Disable 1: Enable (Default) OSD compression function must be enabled simultaneously.
1	R/W	Global Blinking Enable 0: Disable 1: Enable
0	R/W	Rotation 0: Normal (data latch 24 bit per 24 bit) 1: Rotation (data latch 18 bit per 24 bit)

Bit	7	6	5	4	3	2	1	0
Firmware	A	B	C	D	E	F	G	H
CW	A	E	B	F	C	G	D	H
CCW	E	A	F	B	G	C	H	D

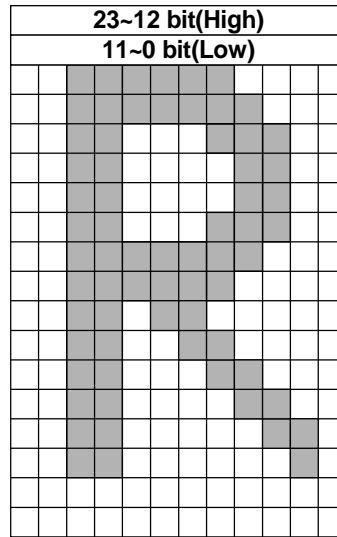

Figure 3 Non-rotated memory alignments

23

6

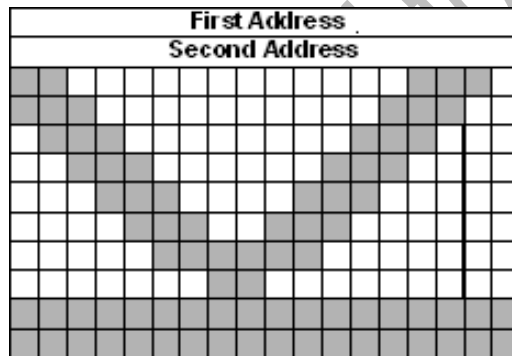

Figure 4 Rotated memory alignments

Base address offset

Address: 004h

Byte 0

Bit	Mode	Function
7:0	R/W	Font Select Base Address[7:0]

Byte 1

Bit	Mode	Function
7:4	R/W	Font Select Base Address[11:8]
3:0	R/W	Font Base Address[3:0]

Byte 2

Bit	Mode	Function
7:0	R/W	Font Base Address[11:4]

When OSD Special Function for POP-ON is enabled (OSD[008]), Font Select Base Address here will not be effective.

OSD Compression

Address: 005h

Byte 0

Bit	Mode	Function
7:4	R/W	4-bit value for VLC code 0
3:0	R/W	4-bit value for VLC code 100

Byte 1

Bit	Mode	Function
7:4	R/W	4-bit value for VLC code 1010
3:0	R/W	4-bit value for VLC code 1011

Byte 2

Bit	Mode	Function
7:4	R/W	4-bit value for VLC code 1100
3:0	R/W	4-bit value for VLC code 1101 0

Address: 006h

Byte 0

Bit	Mode	Function
7:4	R/W	4-bit value for VLC code 1101 1
3:0	R/W	4-bit value for VLC code 1110 0

Byte 1

Bit	Mode	Function
7:4	R/W	4-bit value for VLC code 1110 10
3:0	R/W	4-bit value for VLC code 1110 11

Byte 2

Bit	Mode	Function
7:4	R/W	4-bit value for VLC code 1111 00
3:0	R/W	4-bit value for VLC code 1111 01

Address: 007h

Byte 0

Bit	Mode	Function
-----	------	----------

7:4	R/W	4-bit value for VLC code 1111 100
3:0	R/W	4-bit value for VLC code 1111 101

Byte 1

Bit	Mode	Function
7:4	R/W	4-bit value for VLC code 1111 110
3:0	R/W	4-bit value for VLC code 1111 1110

Byte 2

default: xxxx_xxx0b

Bit	Mode	Function
7:1	--	reserved
0	R/W	OSD compression (4bit/symbol, VLC code 1111_1111 represents the end of data) (only for SRAM) 0: disable 1: enable

Note:

1. If enable OSD compression or auto load (double buffer), only one byte can be read after writing address at 0x90, 0x91.
2. For OSD compression, MSB 4 bits of original byte is first transferred to corresponding VLC code, and then LSB 4 bits is transferred. VLC code is placed from LSB to MSB of compression font. For example, 4-bit value for VLC code 1100 is 4'b0101, and 4-bit value for VLC code 100 is 4'b0001. Original data 0x15 is transferred to compression x0011001.
3. OSD double buffer and compression can't be enabled simultaneous.
4. When power-down mode or lack of crystal clock, OSD compression font can't be write.
5. After OSD enable, it is better to delay 1 DVS to start writing OSD compression data.

OSD Special Function

Address: 008h

Byte 0

Default: 0x00

Bit	Mode	Function
7	R/W	OSD Special Function Enable 0: Disable 1: Enable
6	R/W	OSD Special Function Select (Effective only when Bit[7]=1) 0: ROLL-UP 1: POP-ON
5	R/W	OSD Vertical Boundary Function Enable 0: Disable 1: Enable

4:1	R/W	Reserved to 0
0	R/W	Display Base Select (Effective only when Bit[7:6]=11`b) 0: Base 0 1: Base 1

Byte 1 Default: 0x00

Bit	Mode	Function
7:0	R/W	Row Command Base 0 [7:0]

Byte 2 Default: 0x00

Bit	Mode	Function
7:0	R/W	Row Command Base 1 [7:0]

Address: 009h

Byte 0 Default: 0x00

Bit	Mode	Function
7:4	R/W	Font Select Base 0 [11:8]
3:0	R/W	Font Select Base 1 [11:8]

Byte 1 Default: 0x00

Bit	Mode	Function
7:0	R/W	Font Select Base 0 [7:0]

Byte 2 Default: 0x00

Bit	Mode	Function
7:0	R/W	Font Select Base 1 [7:0] (Not effective when ROLL-UP)

Address: 00Ah

Byte 0 Default: 0x00

Bit	Mode	Function
7	R/W	Reserved
6:4	R/W	OSD Vertical Upper Boundary [10:8]
3	R/W	Reserved
2:0	R/W	OSD Vertical Lower Boundary [10:8]

Byte 1 Default: 0x00

Bit	Mode	Function
7:0	R/W	OSD Vertical Upper Boundary [7:0]

Byte 2 Default: 0x00

Bit	Mode	Function
7:0	R/W	OSD Vertical Lower Boundary [7:0]

Note:

1. When OSD Special Function for POP-ON is enabled, Font Select Base Address in OSD[004] will not be effective anymore.
2. When OSD Vertical Boundary Function is enabled, OSD image above upper boundary and below lower boundary will be invisible.
3. When ROLL-UP function is enabled, OSD will always start from the row-command pointed by Base0, and after the row-command pointed by Base1 has been dealt with, the next row-command will be the first one in OSD SRAM. Row-command processing will terminate in the row-command before the one pointed by Base0. (For example, R1 is pointed by Base0, and R5 is pointed by Base1. OSD will show R1 as the first row, followed by R2, R3, R4, R5, and R0 as last row.)
4. When POP-ON function is enabled, OSD will start from the row command pointed by the base selected as display base(selected by OSD[008][0.0]), and terminate when end-command is encountered. That is, all row-command will be separated into two non-overlay subset which is enclosed by the row-command pointed by base and end-command.

OSD SRAM (Map and font registers)

R0	R1	R2	Rn	End			
C01	C02	B03	C04	...	C11	C12	C13	...
....								
....								
...		Cn1	Cn2	...	1-bit font start	...		
....								
...		2-bit font start		...				
....								
4-bit font start		...						
....								
....								

16.5k bytes SRAM

1. Row Command

R0	R1	R2	R3	R....	Rn	End
----	----	----	----	-------	----	-----

Row Command R0~Rn represent the start of new row. Each command contains 3 bytes data which define the length of a row and other attributes. OSD End Command represent the end of OSD. R0 is set in address 0 of SRAM.

2. Character/Blank Command (Font Select)

Character Command is used to select which character font is show. Each command contains three bytes which specify its attribute and 1,2 or 4bit per pixel. Blank Command represents blank pixel to separate the preceding character and following character. Use two or more Blank Command if the character distance exceeds 255 pixel.

The Font Select Base Address in Frame Control Register represents the address of the first character in Row 0, that is, C01 in the above figure. The following character/blank is write in the next address. C11 represents the first character in Row1, C12 represents the second character in Row1, and so on.

The address of the first character Cn1 in Row n = Font Select Base Address + Row 0 font base length + Row 1 font base length + ...+Row n-1 font base length.

Realtek Confidential for GM Only

3. Font

User fonts are stored as bit map data. For normal font, one font has 12x18 pixel, and for rotation font, one has 18x12 pixel. One pixel use 1, 2 or 4 bits.

For 12x18 font,

One 1-bit font requires $9 * 24$ bit SRAM

One 2-bit font requires $18 * 24$ bit SRAM

One 4-bit font requires $36 * 24$ bit SRAM

For 18x12 font,

One 1-bit font requires $12 * 24$ bit SRAM

One 2-bit font requires $24 * 24$ bit SRAM

One 4-bit font requires $48 * 24$ bit SRAM

Font Base Address in Frame Control Register point to the start of 1-bit font.

For normal (12x18) font:

1-bit Font, if CS = 128, Real Address of Font = Font Base Address + $9 * 128$

2-bit Font, if CS = 128, Real Address of Font = Font Base Address + $18 * 128$

4-bit Font, if CS = 128, Real Address of Font = Font Base Address + $36 * 128$

For rotational (18x12) font:

1-bit Font, if CS = 128, Real Address of Font = Font Base Address + $12 * 128$

2-bit Font, if CS = 128, Real Address of Font = Font Base Address + $24 * 128$

4-bit Font, if CS = 128, Real Address of Font = Font Base Address + $48 * 128$

where CS is Character Selector in Character Command.

Note that Row Command, Font Select and Font share the same OSD SRAM.

When we download the font, we have to set the Frame control 002h byte1 [1:0] to set the method of hardware bit swap. If the OSD is Counter-Clock-Wise rotated, we have to set to 0x01 (the 8 bits of every byte of font SRAM downloaded by firmware will be in a sequence of "7 5 3 1 6 4 2 0" (from MSB to LSB) and should be rearranged to "7 6 5 4 3 2 1 0" by hardware). If it is Clock-Wise rotated, we have to set to 0x10 (the 8 bits of every byte of font SRAM downloaded by firmware will be in a sequence of "6 4 2 0 7 5 3 1" (from MSB to LSB) and should be rearranged to "7 6 5 4 3 2 1 0" by hardware). After we finish the downloading or if we don't have to rotate the OSD, we have to set it to 0x00.

Row Command

Byte 0

Bit	Mode	Function
7	W	1: Row Start Command 0: OSD End Command Each row must start with row-command, last word of OSD map must be end-command
6	R/W	VBI OSD function enable 0: normal OSD function as usual 1: support VBI OSD functions like underline, B/F separated blink and 512 fonts select
5	W	Reserved
4:2	W	Character border/shadow 000: None 001: Border 100: Shadow (left-top) 101: Shadow (left-bottom) 110: Shadow (right-top) 111: Shadow (right-bottom)
1	W	Double character width 0: x1 1: x2
0	W	Double character height 0: x1 1: x2

Byte 1

Bit	Mode	Function
7:3	W	Row height (1~32)
2:0	W	Column space 0~7 pixel column space When Char is doubled, so is column space.

Notice:

When character height/width is doubled, the row height/column space definition also twice. If the row height is larger than character height, the effect is just like space between rows. If it is smaller than character height, it will drop last several bottom line of character.

When using 1/2/4LUT font, column space and font smaller than row height, the color of column space and row space is the same as font background color, only 4 bit true color font mode, the color is transparent

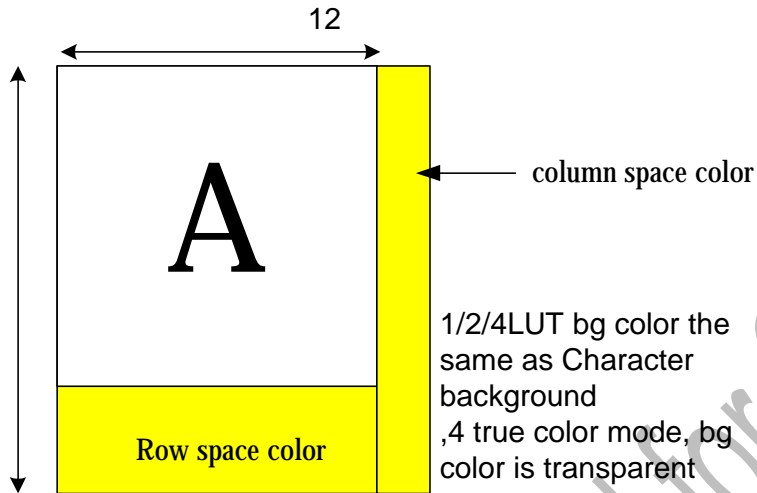

Byte 2

Bit	Mode	Function
7:0	W	Row length unit: font base

Character Command (For blank)

Byte 0

Bit	Mode	Function
7	W	0
6	W	Blinking effect 0: Disable 1: Enable
5:0	W	Reserved

Byte 1

Bit	Mode	Function
7:0	W	Blank pixel length

At least 3 pixels, and can't exceed 255 pixels.

Byte 2

Bit	Mode	Function
7:5	W	Reserved
4	W	Reserved
3:0	W	Blank color – select one of 16-color LUT (0 is special for transparent)

Character Command (For 1-bit RAM font)

Byte 0

Bit	Mode	Function
7	W	1
6	W	Character Blinking effect 0: Disable 1: Enable
5:4	W	00 (Font type 00: 1-bit RAM Font 01: 4-bit RAM Font 1x: 2-bit RAM Font)
3:0	W	VBI OSD disable: Character width (only for 1-pixel font, doubled when specifying double-width in Row/Blank command register) For 12x18 font: 0100: 4-pixel 0101: 5-pixel 0110: 6-pixel 0111: 7-pixel 1000: 8-pixel 1001: 9-pixel 1010: 10-pixel 1011:11-pixel 1100: 12-pixel For 18x12 Font (rotated) 0000: 4-pixel 0001: 5-pixel 0010: 6-pixel 0011: 7-pixel 0100: 8-pixel 0101: 9-pixel 0110: 10-pixel 0111: 11-pixel 1000: 12-pixel 1001:13-pixel 1010:14-pixel 1011:15-pixel 1100: 16-pixel 1101:17-pixel 1110:18-pixel VBI OSD enable: While VBI OSD enable, 1 bit font will be NO rotated and 12-pixel fonts always. Then the [3:0] setting will be as following: [3]: character select[8] support 512 font while VBI OSD enable

		[2]: additional blinking effect {[6], [2]} 00: NO blink for both F/B 01: Only blink for Foreground 10: Only blink for Background 11: Both blink for F/B [1]: Underline enable underline will be at 17th & 18th line and got the same color with foreground [0]: Reserved
--	--	--

When using border/shadow/ effect, the width of the 1-bit font should at least 6 pixel.

Byte 1

Bit	Mode	Function
7:0	W	Character Select [7:0]

Byte 2

Bit	Mode	Function
7:4	W	Foreground color Select one of 16-color from color LUT
3:0	W	Background color Select one of 16-color from color LUT (0 is special for transparent)

Character command (For 2-bit RAM Font)

Byte 0

Bit	Mode	Function
7	W	1
6	W	MSB of Foreground color 11, Background 00
5	W	1
4	W	MSB of Foreground color 10, Foreground 01
3:1	W	Foreground color 11 Select one of 8 color from color LUT Add Byte0 [6] as MSB for 16-color LUT.
0	W	Background color 00 Bit[2] Select one of 8 color from color LUT

Byte 1

Bit	Mode	Function
-----	------	----------

7:0	W	Character Select [7:0]
-----	---	------------------------

Byte 2

Bit	Mode	Function
7:6	W	Background color 00 Bit[1:0] Select one of 8 color from color LUT While 0 is special for transparent Add Byte0 [6] as MSB for 16-color LUT. Once we fill 0000 or 1000(MSB follow Byte0[6]), BG appears transparent.
5:3	W	Foreground color 10 Select one of 8 color from color LUT Add Byte0 [4] as MSB for 16-color LUT.
2:0	W	Foreground color 01 Select one of 8 color from color LUT Add Byte0 [4] as MSB for 16-color LUT.

Character command (For 4-bit RAM font)
Byte 0

Bit	Mode	Function
7	W	1
6	W	Character Blinking effect 0: Disable 1: Enable
5:4	W	01 (Font type 00: 1-bit RAM Font 01: 4-bit RAM Font 1x: 2-bit RAM Font)
3:0	W	(for Byte1[7] = 0) select one color from 16-color LUT as background (for Byte1[7] = 1) Red color level MSB 4 bits for 8 bits color level (LSB 4 bits are 1111)

Byte 1

Bit	Mode	Function
7	W	0: 4bit Look Up Table, 0000'b is transparent. 1: 3bit specify R,G,B pattern, color level defined in Byte0[3:0],Byte2. One

		mask bit defines foreground or background.
6:0	W	Character Select [6:0]

- l When 4-bit look-up table mode , color of column space is the same as background.
- l When 4-bit look-up table mode and pixel value is 0000, and byte0[3:0]=0000 means transparent.
- l When true color mode and pixel value is 0000 , it is transparent °

Byte 2

Bit	Mode	Function
7:4	W	(for Byte1[7] = 1) Green color level MSB 4 bits for 8 bits color level (LSB 4 bits are 1111)
3:0	W	(for Byte1[7] = 1) Blue color level MSB 4 bits for 8 bits color level (LSB 4 bits are 1111)

4. Electric Specification

DC Characteristics

Table 2 Absolute Maximum Ratings

PARAMETER	SYMBOL	MIN	TYP	MAX	UNITS
Voltage on Input (5V tolerant)	V _{IN}	-1		5	V
Electrostatic Discharge	V _{ESD}			±2.5	kV
Latch-Up	I _{LA}			±100	mA
Ambient Operating Temperature	T _A	0		70	°C
Storage temperature (plastic)	T _{STG}	-55		125	°C
Thermal Resistance (Junction to Air)	θ _{JA}			25	°C/W
Junction Acceptable Temperature	T _j			125	°C

Table 3 DC Characteristics/Operating Condition

(0°C<TA<70°C)

【Power consumption : Embedded MCU】

Dot-pattern(check_11).

【1】 VGA-in: 1600x1200/75Hz , display to 1680x1050/75Hz , DCLK=170MHz.

Pattern Generator : 『 Chroma 2227 』 ; Pattern Name : 『 Dot 』 pattern

【2】 Video Decoder-in : DVD-player ; AV-in ; display to 1680x1050

Power Name	Voltage	Operating(mA)	Power saving(mA)	Power down(mA)
VCCK(core)(VGA)	1.8V	438	14.9	5.9
VCCK(core)	1.8V	455	8.5	6.1
VCCK(core)(Video Decoder)	1.8V	232	8.6	6.1
ADC_VDD	1.8V	123	0.1	0.1
VDD	3.3V	173	19.9	19.9
VADC_VDD	3.3V	65.6	0.1	0.1
PVCC(LVDS)	3.3V	78.5	2.5	2.5
PVCC(TTL)	3.3V	34.1	12.8	12.8

5. Mechanical Specification

128 Pin Package

Symbol	Dimension in mm		Dimension in inch	
	Min	Max	Min	Max
A	—	1.60	—	0.063
A1	0.05	0.15	0.002	0.006
A2	1.35	1.45	0.053	0.057
b	0.17	0.22	0.007	0.011
b1	0.17	0.20	0.007	0.008
c	0.09	0.20	0.004	0.008
c1	0.09	0.16	0.004	0.006
D	21.90	22.00	0.862	0.870
D1	19.90	20.00	0.783	0.791
F	15.90	16.00	0.626	0.634
F1	13.90	14.00	0.547	0.555
Ø	0.50	BSC	0.020	BSC
L	0.45	0.60	0.018	0.030
L1	1.00	REF	0.039	REF
R1	0.08	—	0.003	—
R2	0.08	0.20	0.003	0.008
S	0.20	—	0.008	—
Ø	0	3.5°	0	3.5°
Ø1	4	TYP	4	TYP
Ø2	12	TYP	12	TYP
Ø3	12	TYP	12	TYP
ccc	0.08	—	0.003	—

PIN 1 IDENTIFIER

DETAIL A-A

SEATING PLAN

WITH PLATING

DETAIL B-B

NOTE :

- △ TO BE DETERMINED AT SEATING PLANE
- △ DIMENSIONS D1 AND E1 DO NOT INCLUDE MOLD PROTRUSION. D1 AND E1 ARE MAXIMUM PLASTIC BODY SIZE DIMENSIONS INCLUDING MOLD MISMATCH.
- △ DIMENSION b DOES NOT INCLUDE DAMBAR PROTRUSION. DAMBAR CAN NOT BE LOCATED ON THE LOWER RADIUS OR THE FOOT.
- △ EXACT SHAPE OF EACH CORNER IS OPTIONAL.
- △ THESE DIMENSIONS APPLY TO THE FLAT SECTION OF THE LEAD BETWEEN 0.10 mm AND 0.25 mm FROM THE LEAD TIP.
- △ A1 IS DEFINED AS THE DISTANCE FROM THE SEATING PLANE TO THE LOWEST POINT OF THE PACKAGE BODY.

Exposed Pad Size

L/F	Dimension in mm	Dimension in inch
①	7.11 REF	0.280 REF
②	8.25 REF	0.325 REF

7. CONTROLLING DIMENSION : MILLIMETER.
 8. REFERENCE DOCUMENT : JEDEC MS-026
 9. SPECIAL CHARACTERISTICS C CLASS: ccc

TITLE: 128LD L-PAD LOFP(14x20x1.4mm)PACKAGE OUTLINE
 -Cu L/F FOOTPRINT 2.0mm

L/F MATERIAL: C7075 1/2H

APPR.	DWG NO.	DB178-SW?
ENG.	REV NO.	B
Q.M	PRODUCT CODE	DB1781C
CHK.	DATE	05/14/06
DWG.	R.K.Wang	SHT NO. 1/1

SILICONWARE PRECISION INDUSTRIES CO., LTD.

COPY CONTROLLED

REV NO	DESCRIPTION	DATE
B	ADD EXPOSED PAD SIZE	05/14/06

6. Ordering Information

Realtek Confidential for GM Only